



US00D514218S

(12) **United States Design Patent**  
**Kaminsky**

(10) **Patent No.:** **US D514,218 S**

(45) **Date of Patent:** **\*\* Jan. 31, 2006**

(54) **AIR VENT**

(75) **Inventor:** **Günther Kaminsky, Karlsruhe (DE)**

(73) **Assignee:** **SAS Autosystemtechnik GmbH Co. KG, Karlsruhe (DE)**

(\*\*) **Term:** **14 Years**

(21) **Appl. No.:** **29/191,646**

(22) **Filed:** **Oct. 10, 2003**

(51) **LOC (8) Cl. .... 23-04**

(52) **U.S. Cl. .... D23/393**

(58) **Field of Classification Search .... D23/370,**  
**D23/112, 388, 327, 392; 126/152 R; 417/316;**  
**474/271; D12/192**

See application file for complete search history.

(56) **References Cited**

**U.S. PATENT DOCUMENTS**

- 957,776 A \* 5/1910 Ilg ..... 417/316
- 2,399,618 A \* 5/1946 Balmfirth ..... 126/152 R
- D218,162 S \* 7/1970 Dawkins ..... D23/327
- D230,736 S \* 3/1974 Rousey ..... D23/370
- D235,876 S \* 7/1975 Dixon ..... D23/392
- D279,601 S \* 7/1985 Sexton ..... D23/388

- D351,903 S \* 10/1994 Whitley, II ..... D23/388
- D417,267 S \* 11/1999 Sacco et al. .... D23/327
- D485,894 S \* 1/2004 Fraser et al. .... D23/327
- D492,632 S \* 7/2004 Pfeiffer ..... D12/192
- D494,907 S \* 8/2004 Pfeiffer ..... D12/192

\* cited by examiner

*Primary Examiner*—Susan Bennett Hattan

(74) *Attorney, Agent, or Firm*—Martin Fleit; Paul D. Bianco; Fleit Kain Gibbons Gutman Bongini & Bianco P.L.

(57) **CLAIM**

The ornamental design for an air vent, as shown and described.

**DESCRIPTION**

FIG. 1 is a top view of an air vent showing my new design;  
 FIG. 2 is a bottom view thereof;  
 FIG. 3 is one side view thereof;  
 FIG. 4 is the other side view thereof;  
 FIG. 5 is a front view showing the louvers of the air vent closed;  
 FIG. 6 is a front view showing the louvers of the air vent opened; and,  
 FIG. 7 is a rear view thereof.

**1 Claim, 6 Drawing Sheets**

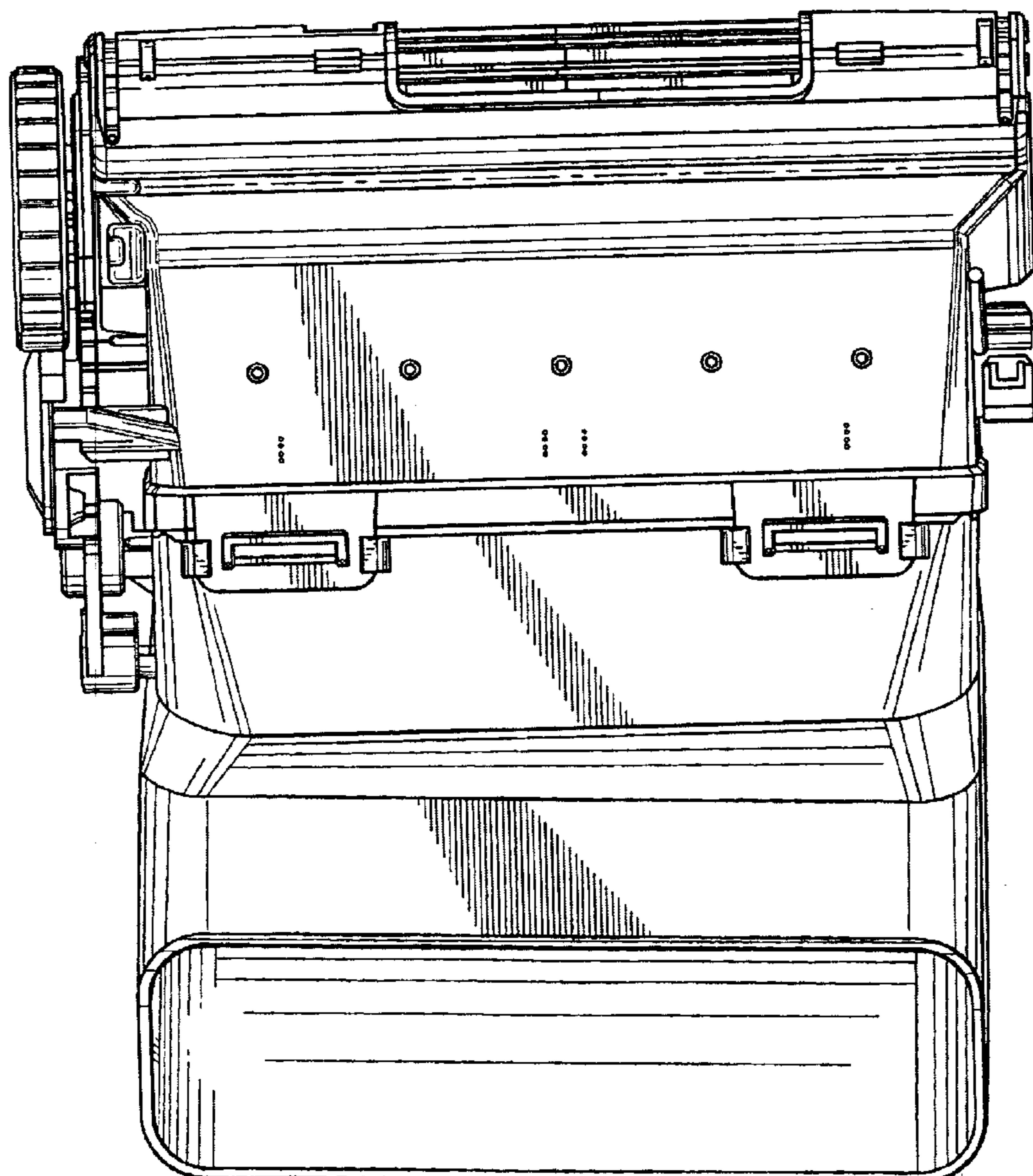

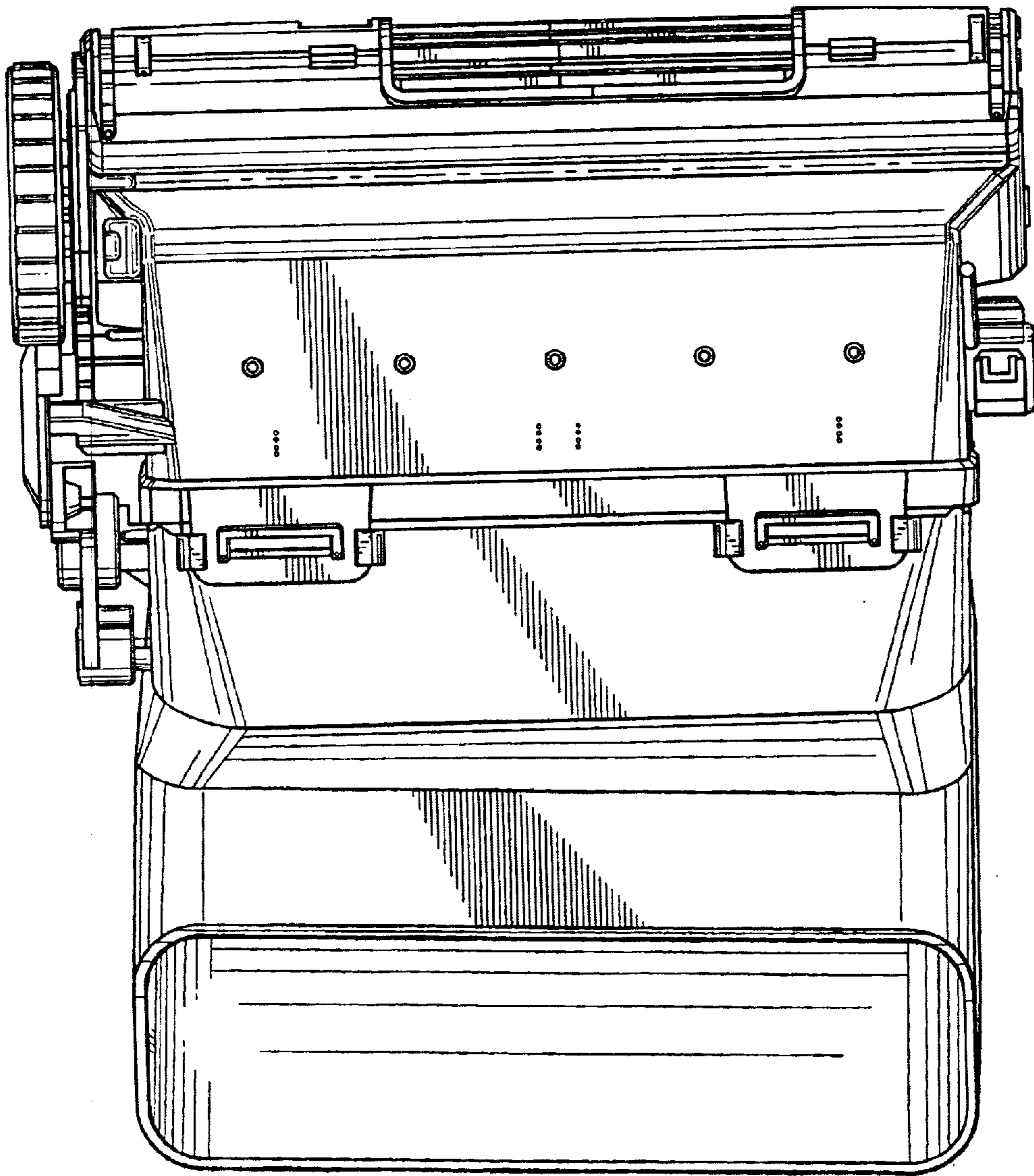

FIG. 1

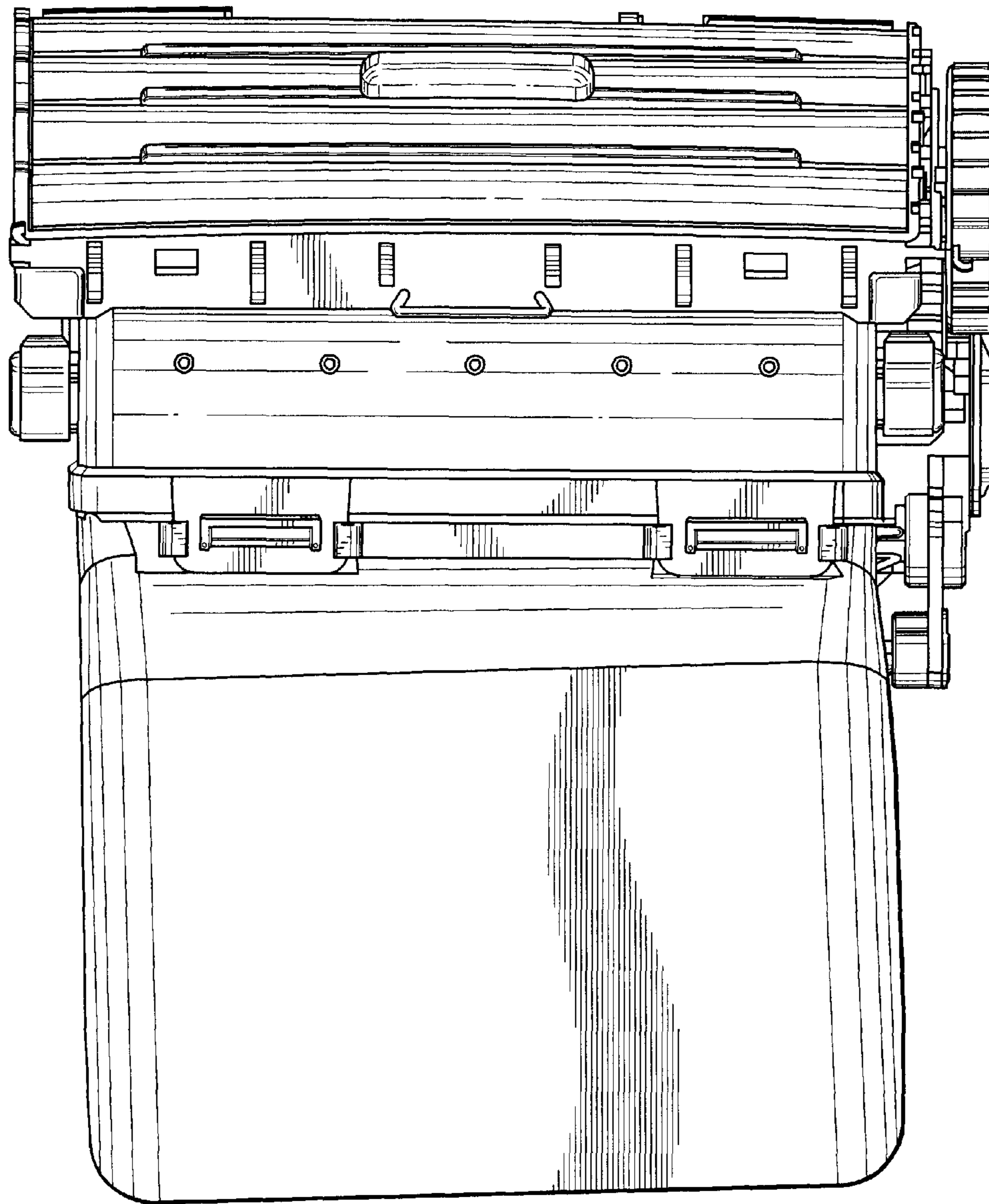

FIG. 2

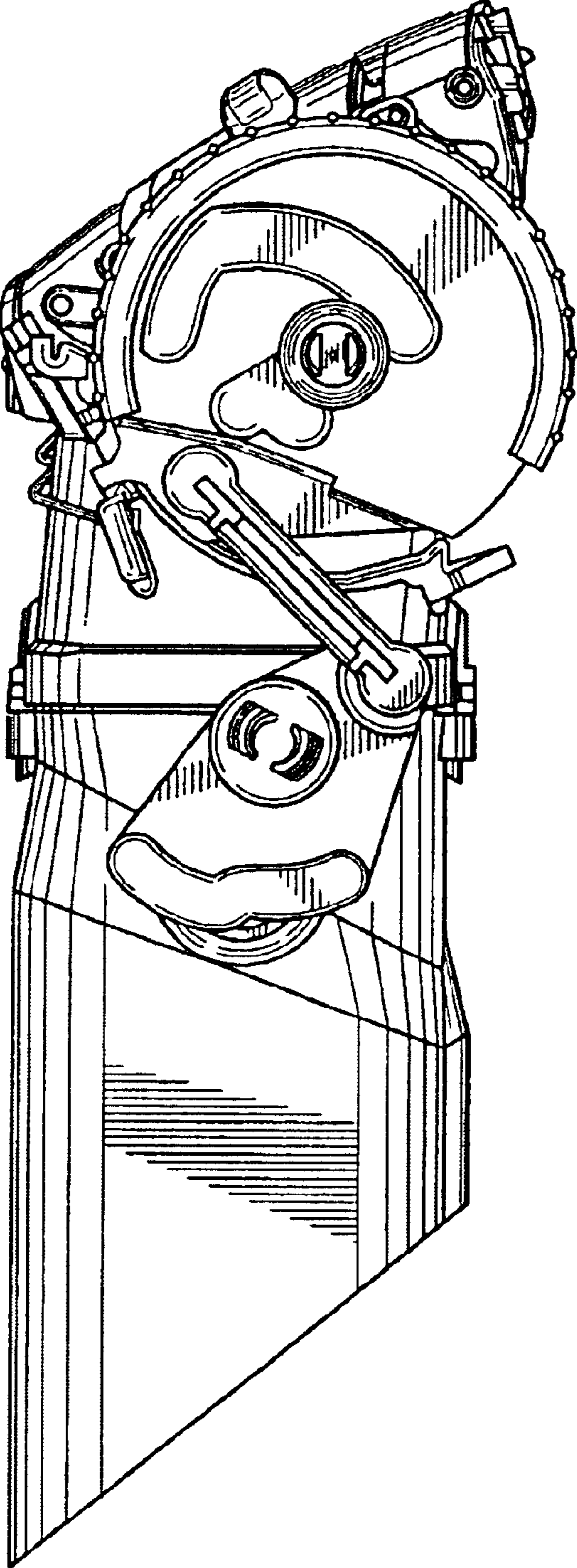

FIG. 3

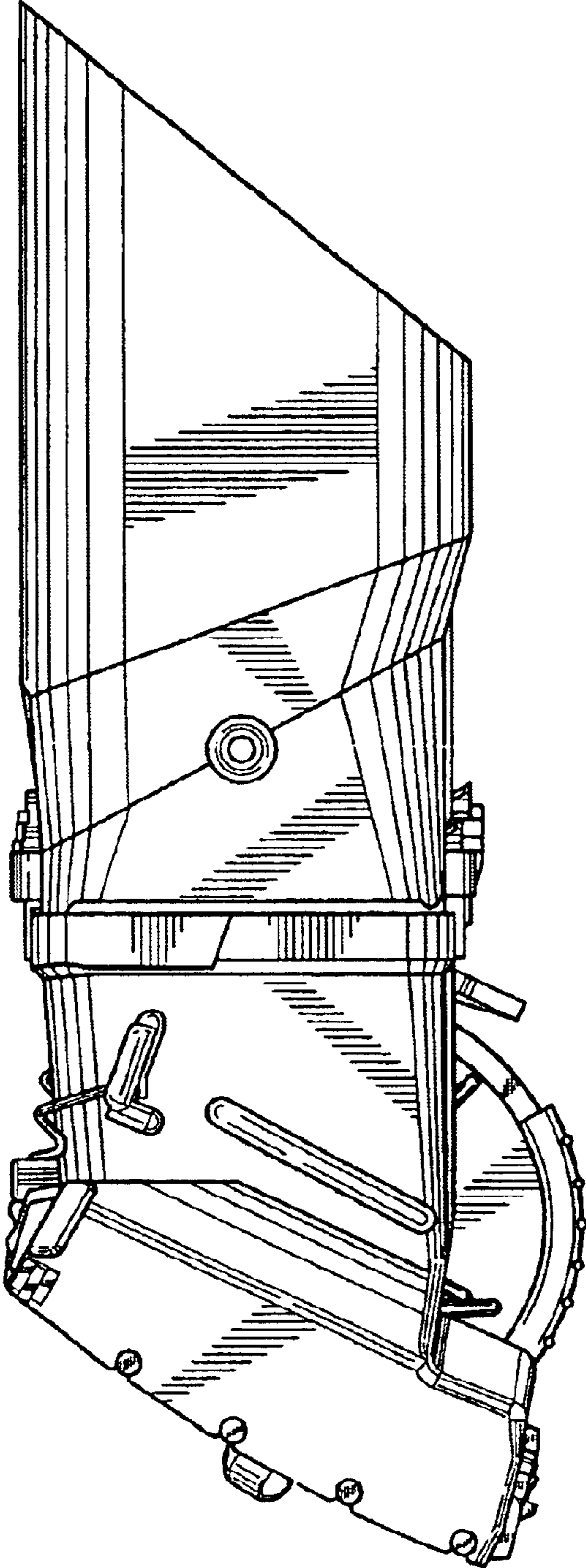

FIG.4

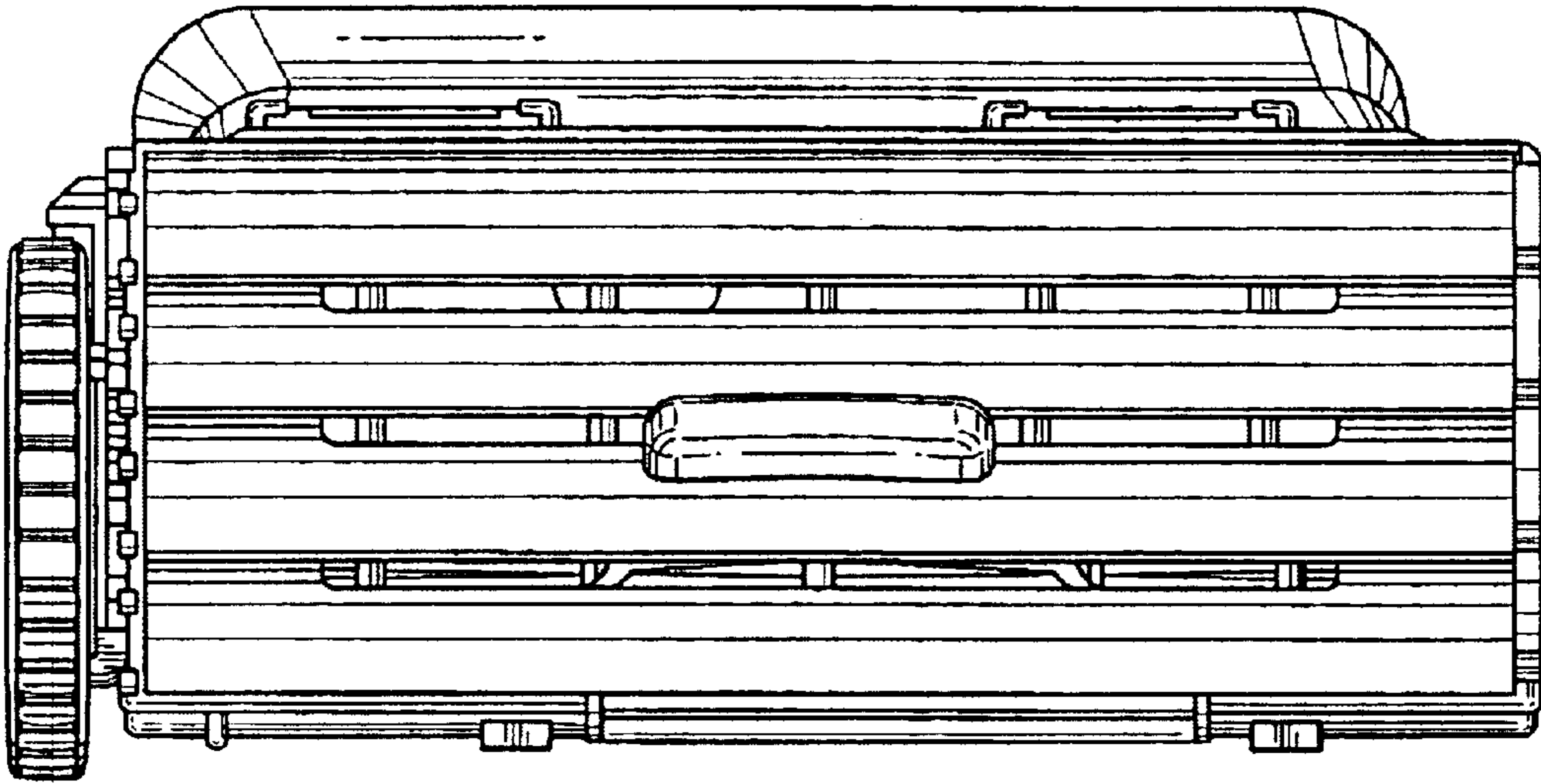

FIG. 5

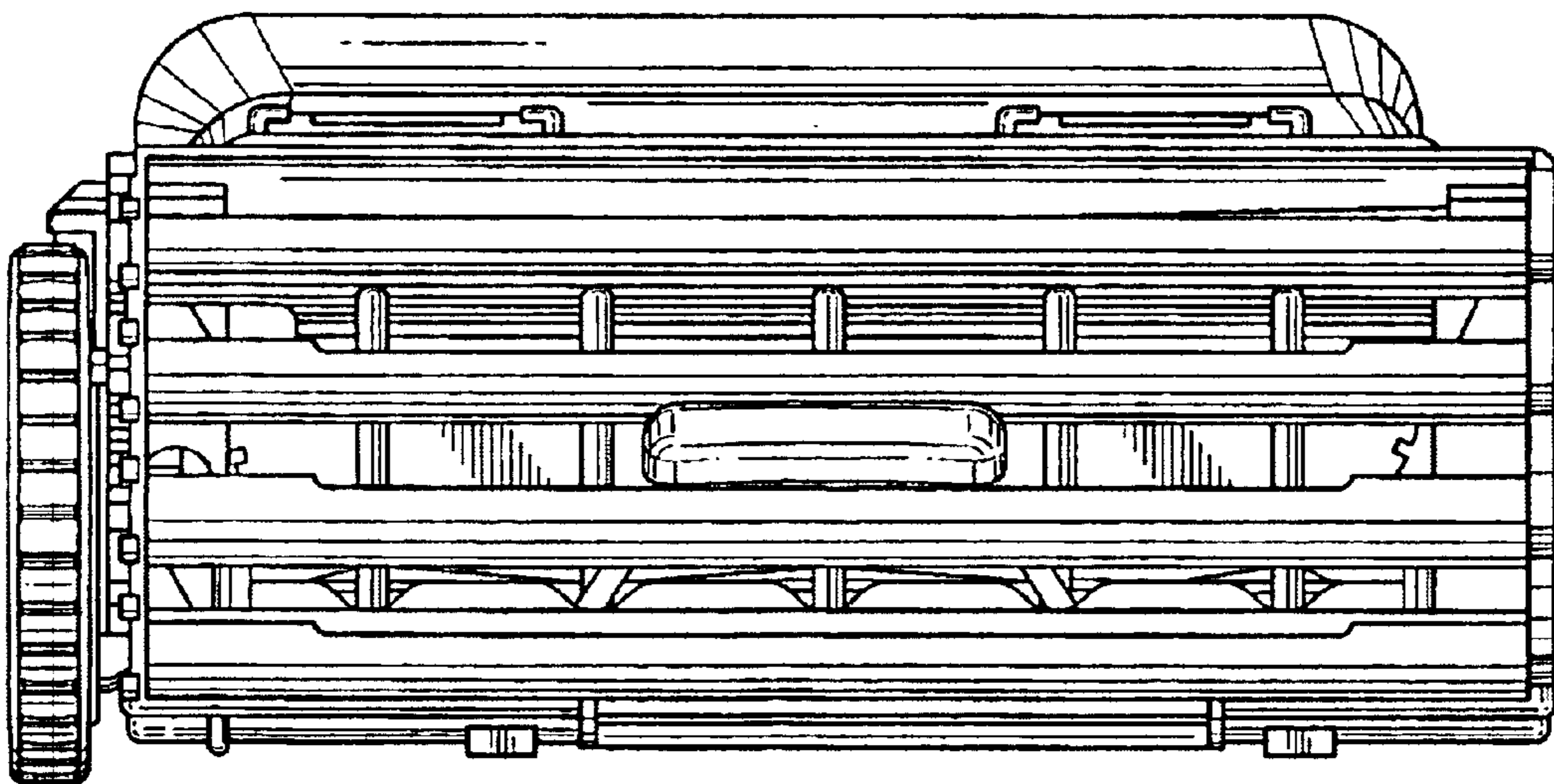

FIG. 6

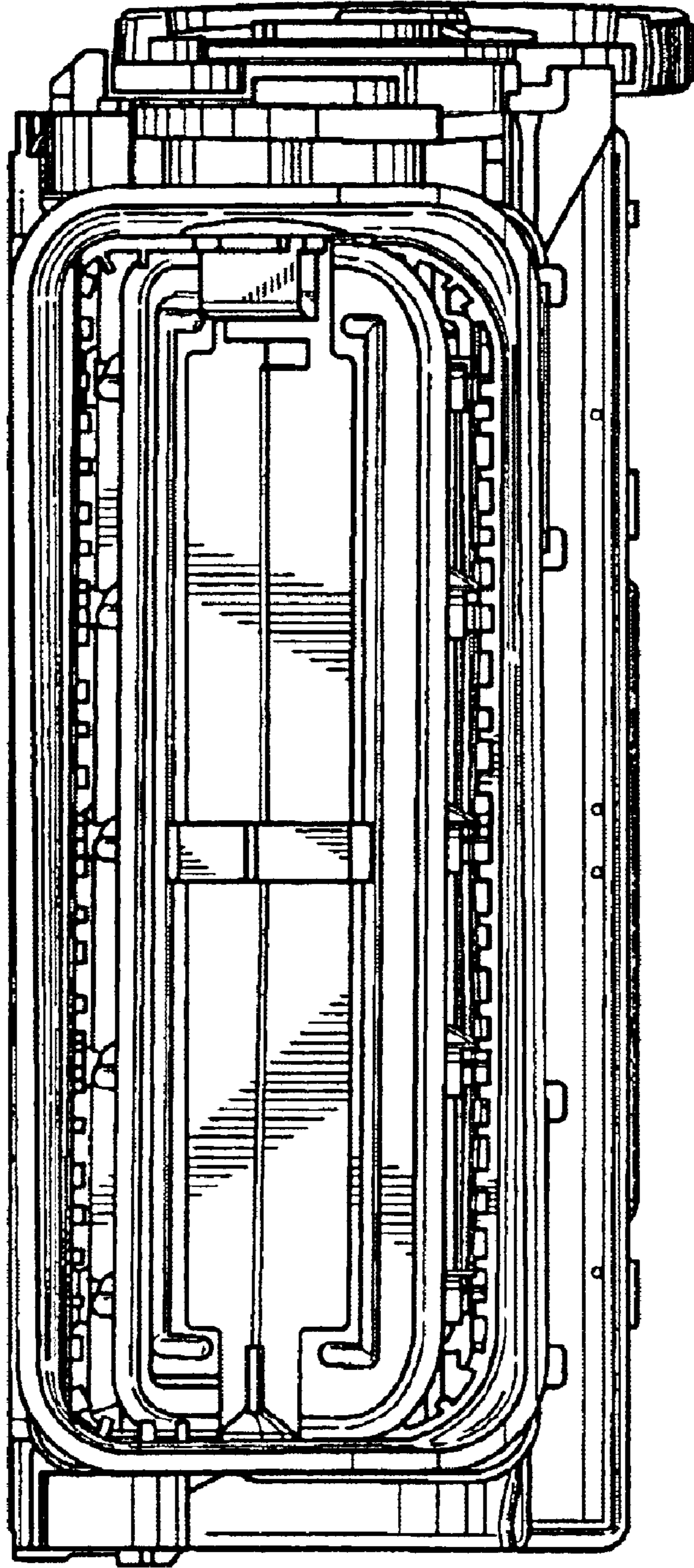

FIG. 7