



US00D514172S

(12) **United States Design Patent**  
**Jinno et al.**

(10) **Patent No.:** **US D514,172 S**  
(45) **Date of Patent:** **\*\* Jan. 31, 2006**

(54) **RADIO REMOTE CONTROL UNIT**

(75) Inventors: **Eiji Jinno**, Chiba-ken (JP); **Noriaki Morita**, Chiba-ken (JP)

(73) Assignee: **Futaba Corporation**, Mobara (JP)

(\*\*) Term: **14 Years**

(21) Appl. No.: **29/191,050**

(22) Filed: **Oct. 2, 2003**

(30) **Foreign Application Priority Data**

Apr. 2, 2003 (JP) ..... 2003-012653

(51) **LOC (8) Cl.** ..... **21-01**

(52) **U.S. Cl.** ..... **D21/566**

(58) **Field of Classification Search** ..... D21/566,  
D21/333, 324, 329, 513; D14/401, 217-218;  
446/454-456, 141-143, 207, 404, 479; 463/29-35,  
463/46-47

See application file for complete search history.

(56) **References Cited**

**U.S. PATENT DOCUMENTS**

- D322,103 S \* 12/1991 Kohno ..... D21/566
- D344,553 S \* 2/1994 Arai ..... D21/566
- 5,499,388 A \* 3/1996 Song ..... 446/456
- D395,472 S \* 6/1998 Kanetsuna et al. .... D21/566
- D471,603 S \* 3/2003 Morita et al. .... D21/566

**OTHER PUBLICATIONS**

Tower Hobbies, p. 39, Aug. 1991.\*

\* cited by examiner

*Primary Examiner*—Raphael Barkai

(74) *Attorney, Agent, or Firm*—Michael Bednarek; Shaw Pittman LLP

(57) **CLAIM**

We claim the ornamental design for a radio remote control unit, as shown and described.

**DESCRIPTION**

The design of the present application is directed to a radio remote control unit for remotely controlling an object such as a toy airplane, boat, car or other propelled device.

FIG. 1 is a front elevational view of a radio remote control unit showing our new design;

FIG. 2 is a rear elevational view thereof;

FIG. 3 is a right side elevational view thereof;

FIG. 4 is a left side elevational view thereof;

FIG. 5 is a top plan view thereof;

FIG. 6 is a bottom plan view thereof;

FIG. 7 is a front side perspective view thereof;

FIG. 8 is a rear side perspective view thereof; and,

FIG. 9 is a perspective view thereof in which the antenna thereof in extended.

**1 Claim, 7 Drawing Sheets**

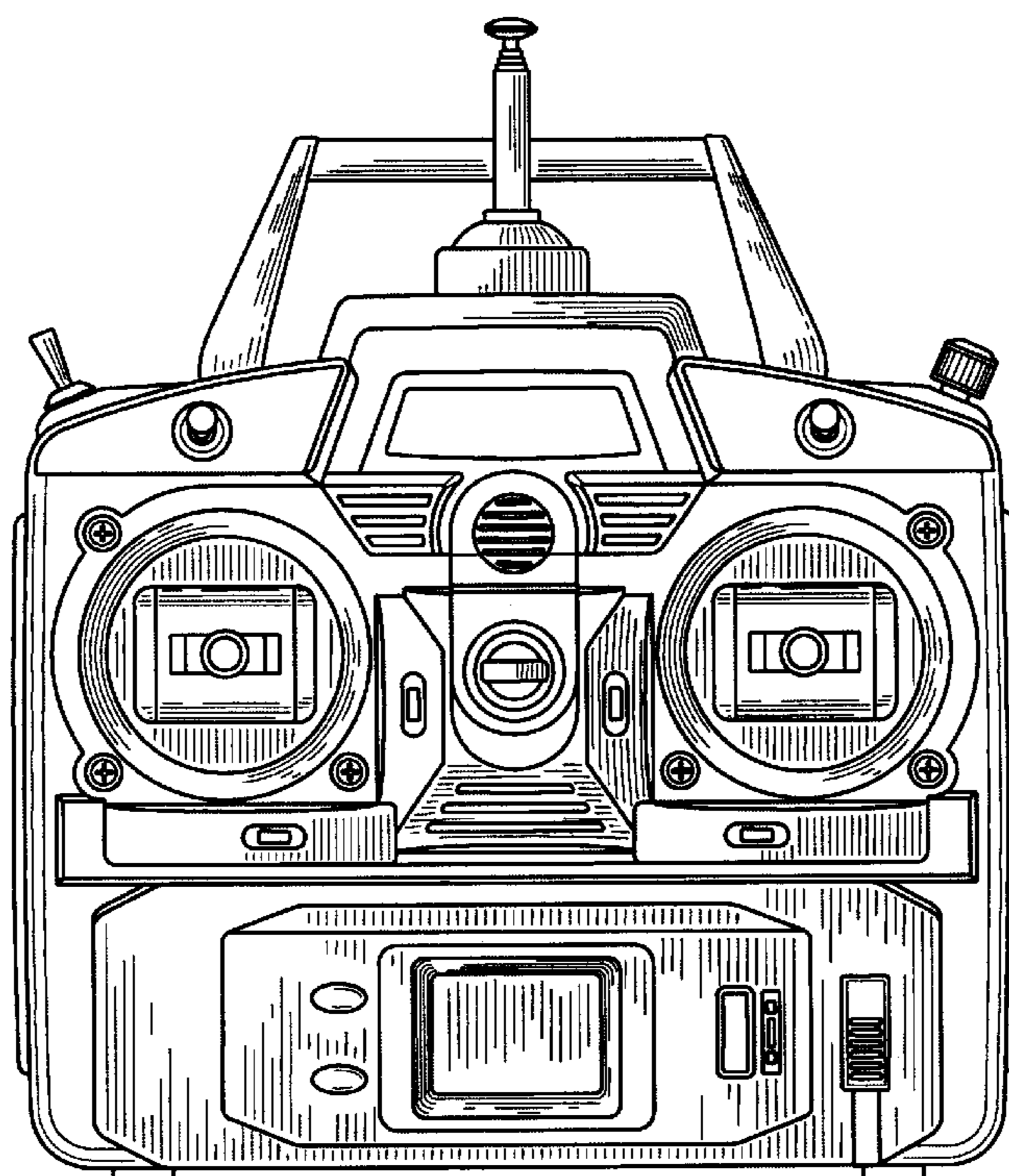

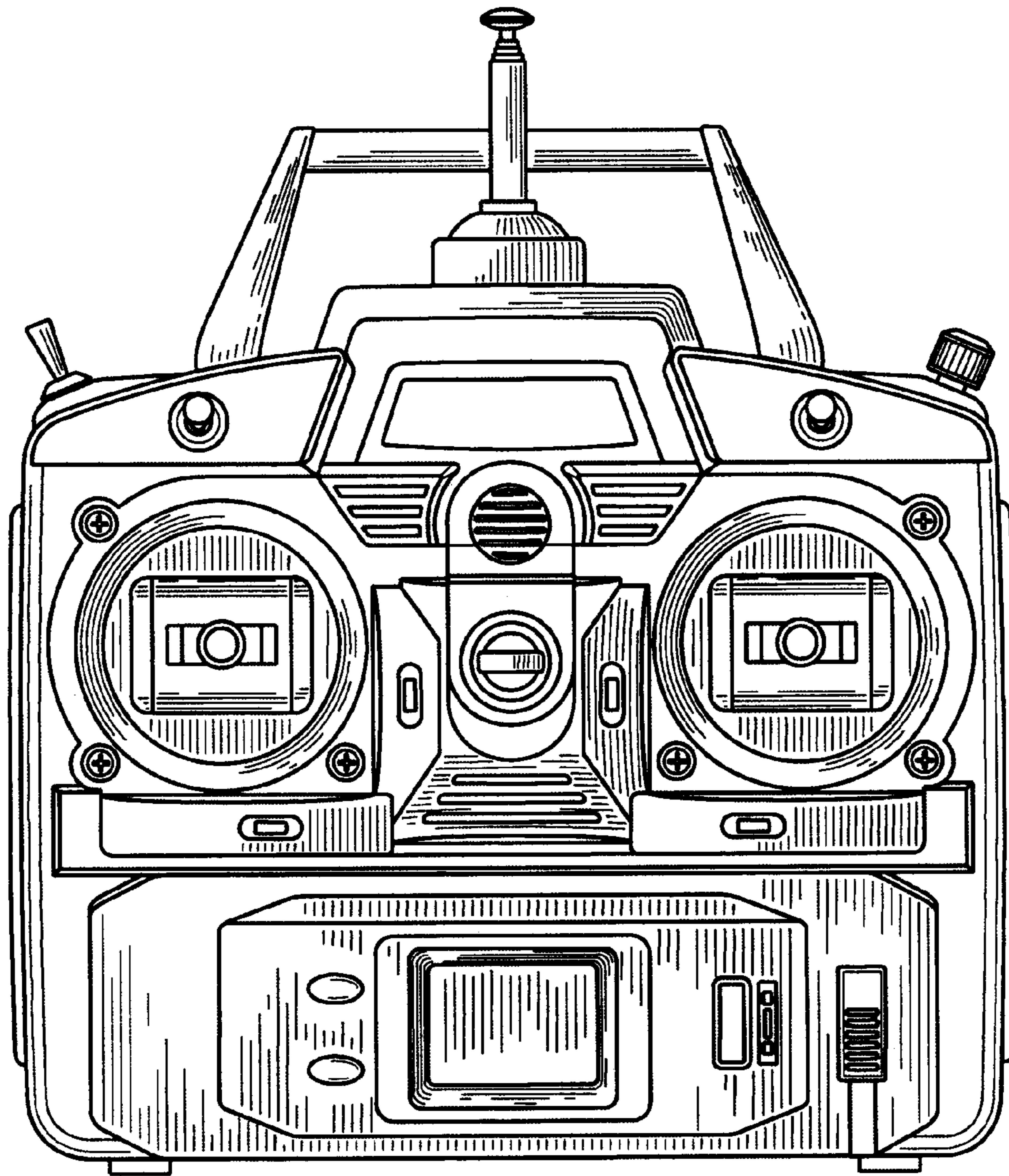

FIG. 1

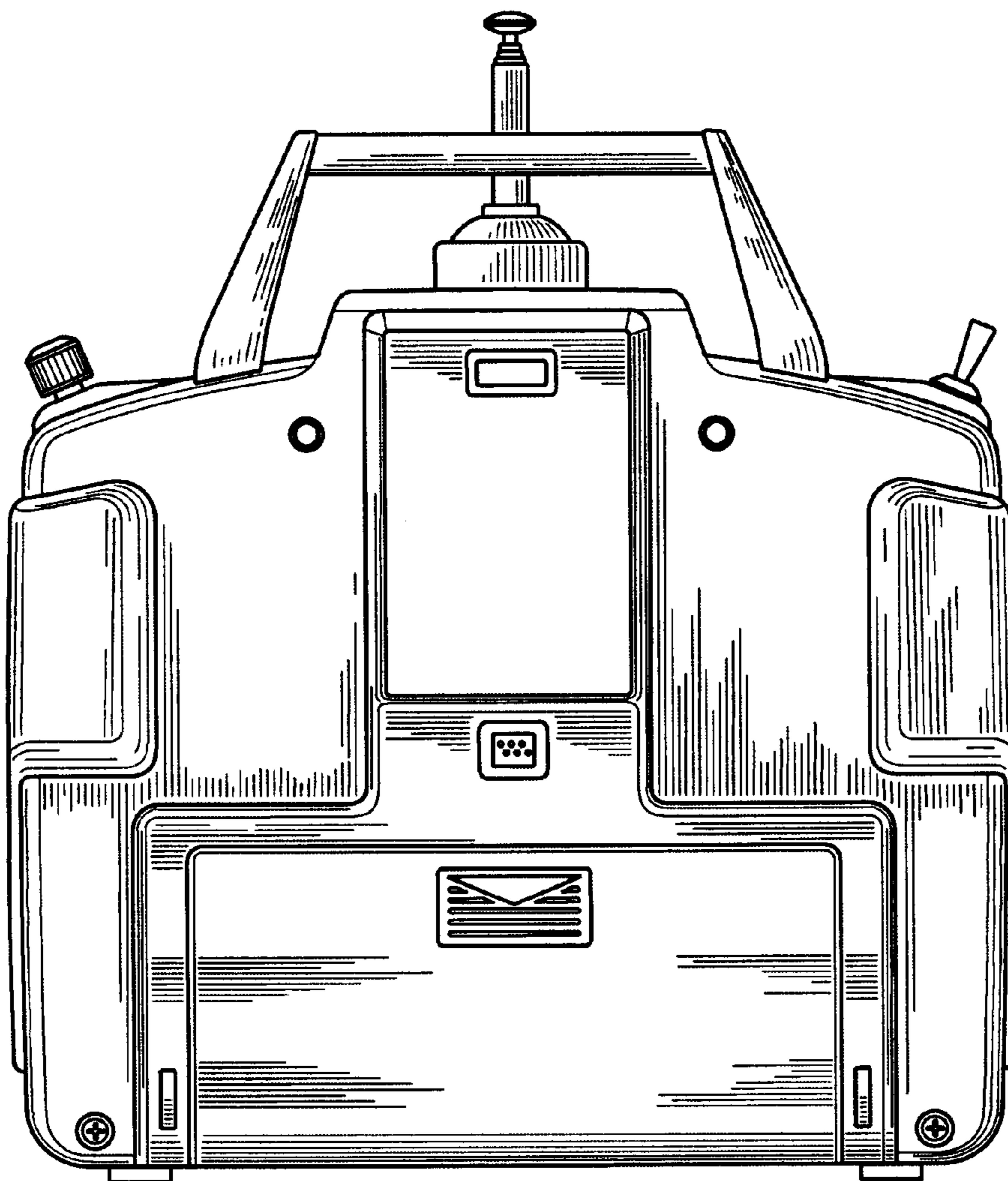

FIG. 2

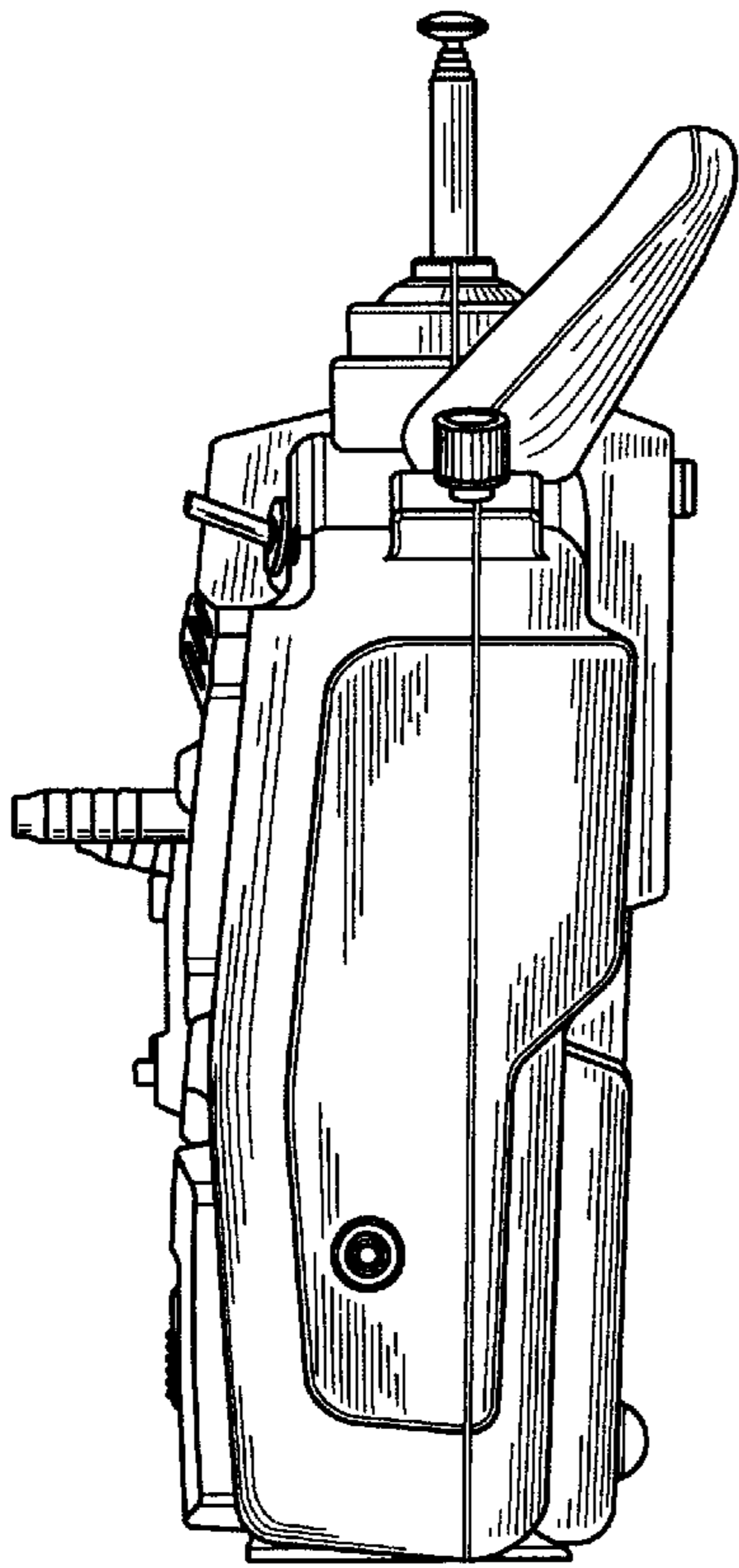

FIG. 3

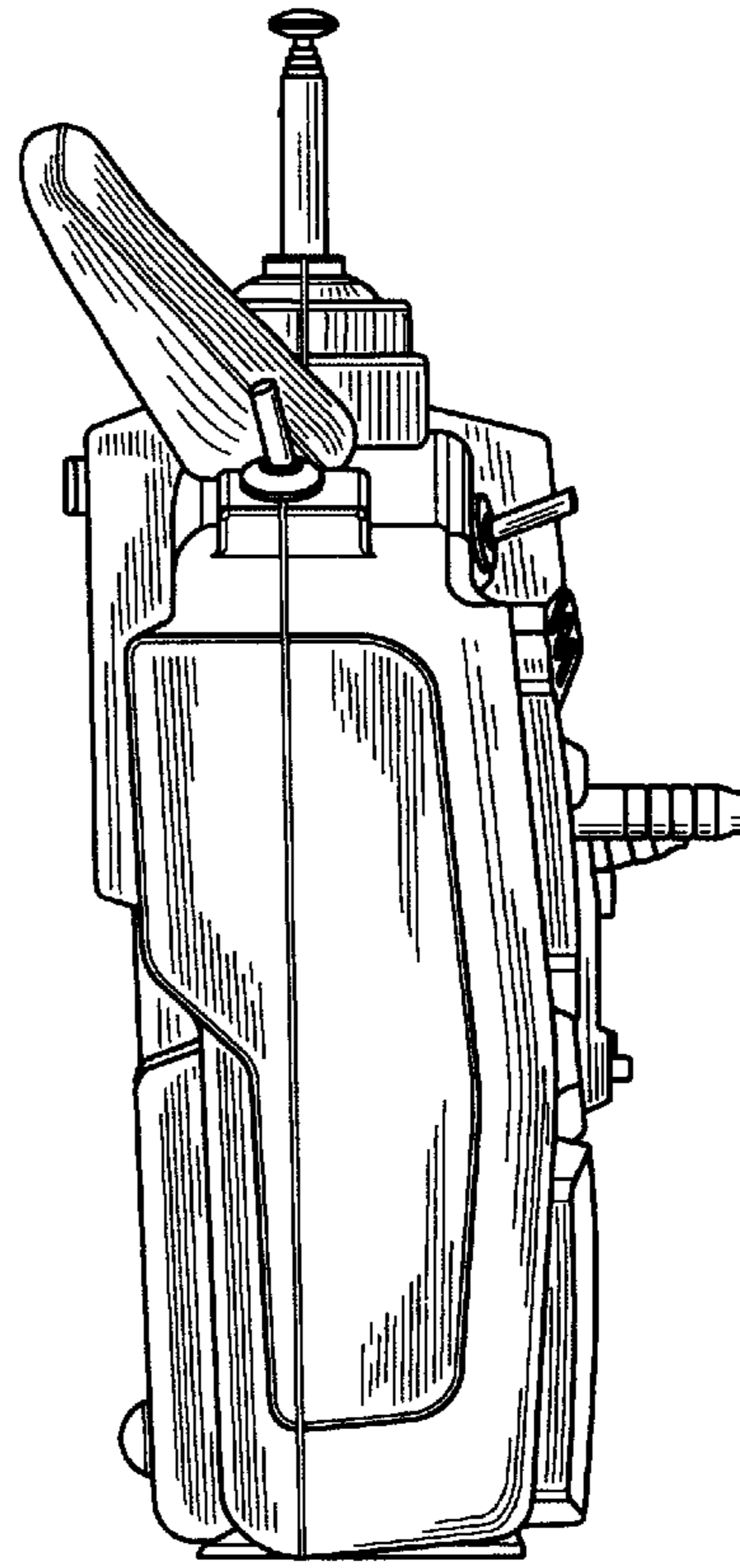

FIG. 4

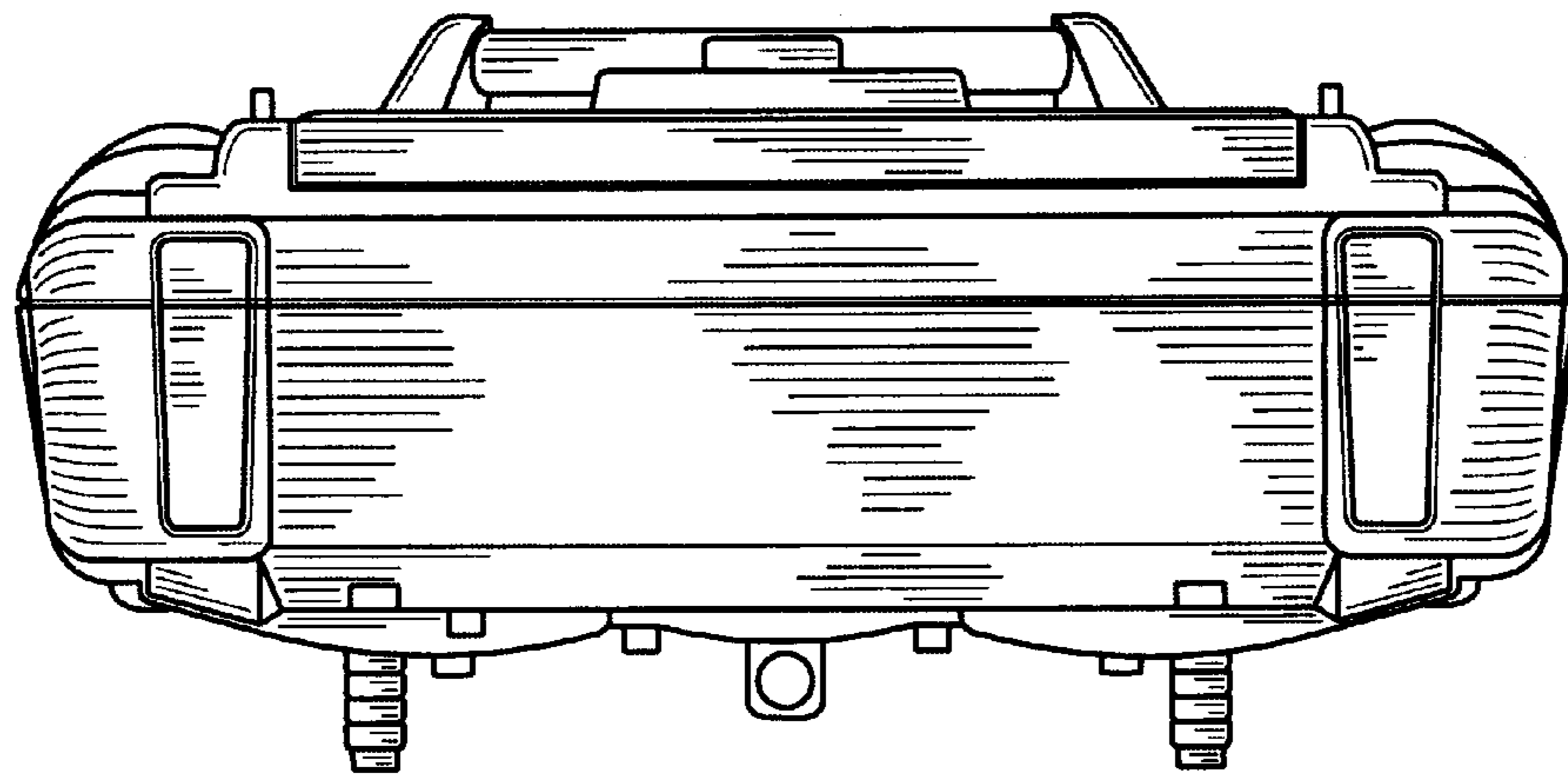

FIG. 5

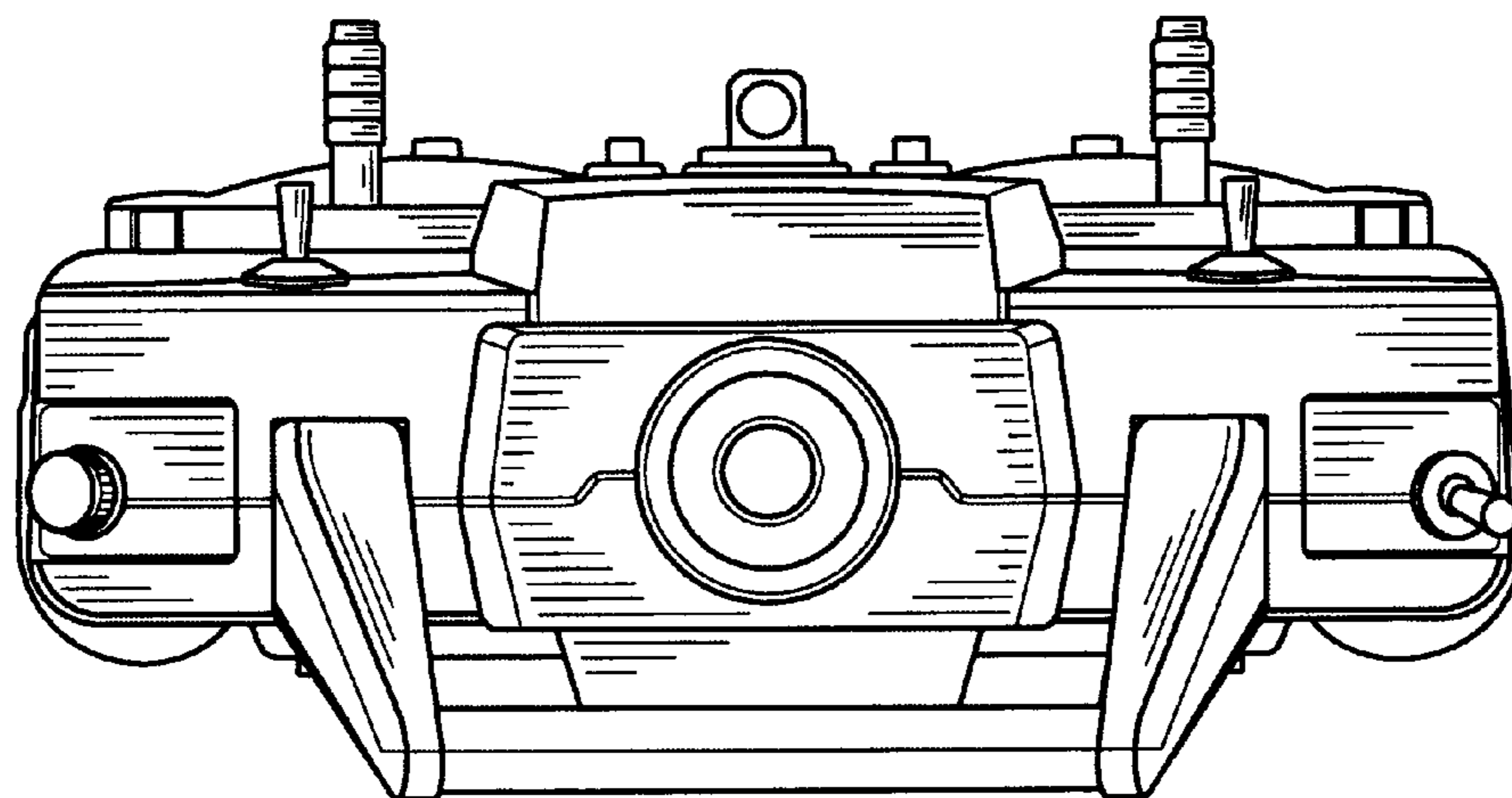

FIG. 6

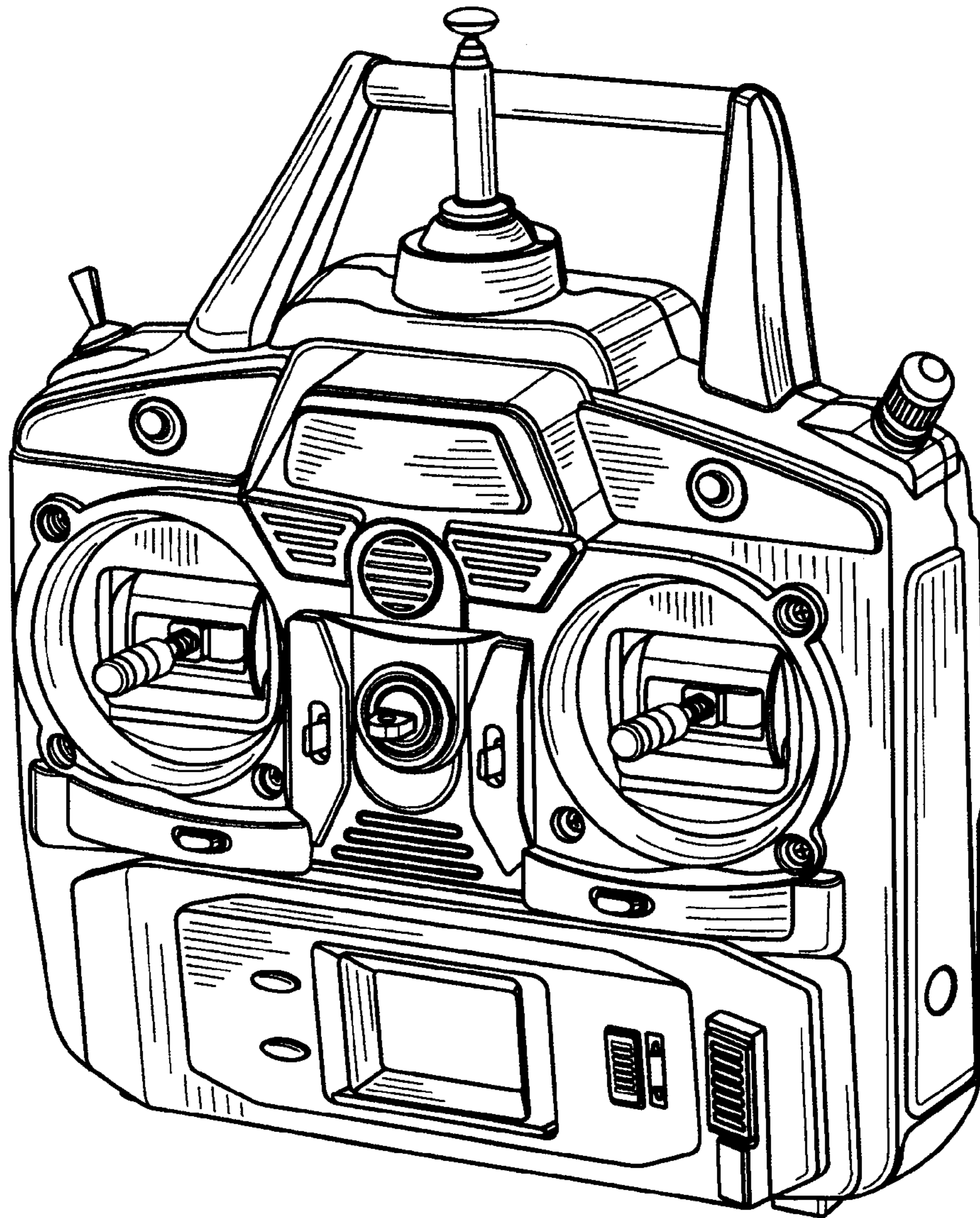

FIG. 7

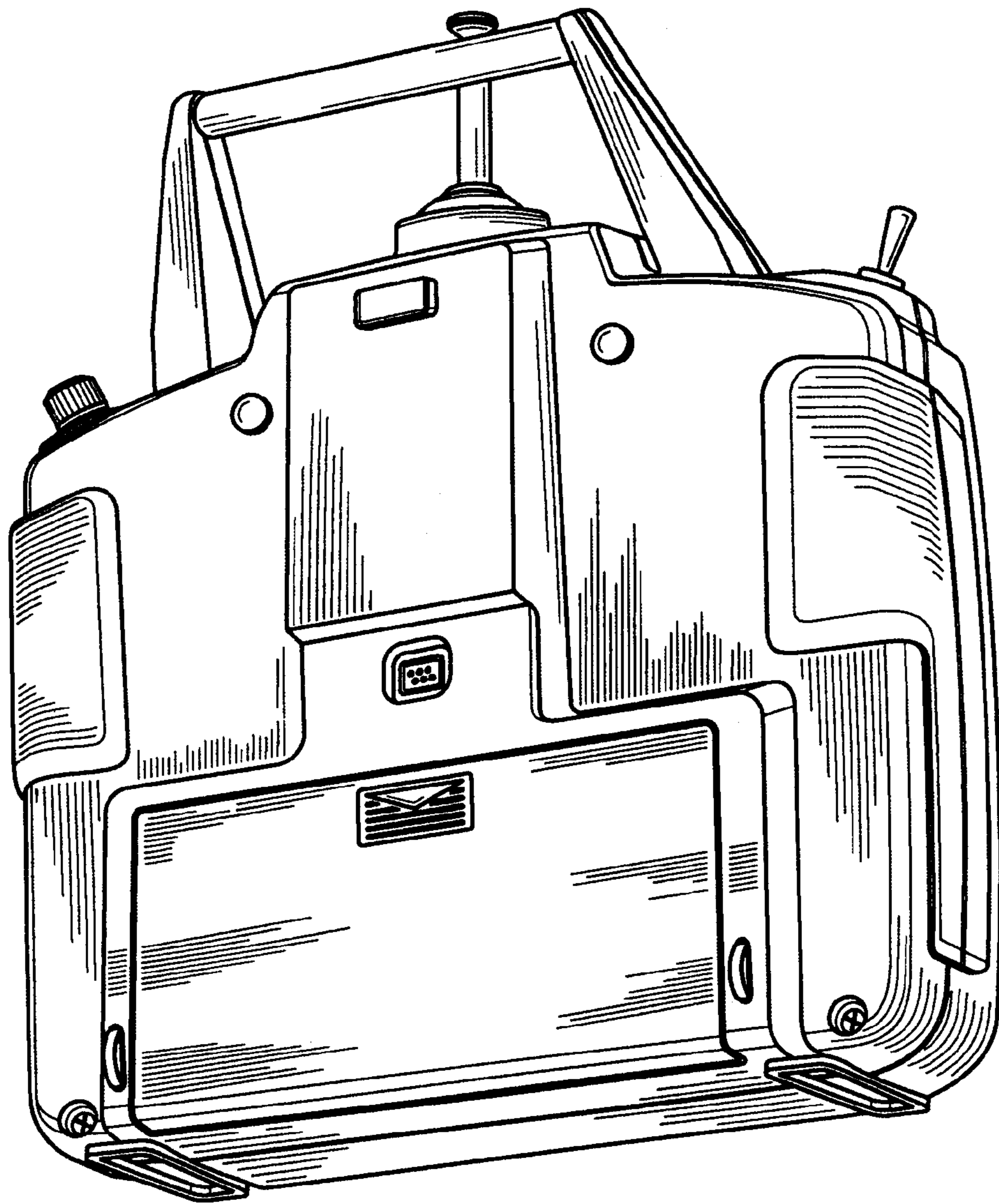

FIG. 8

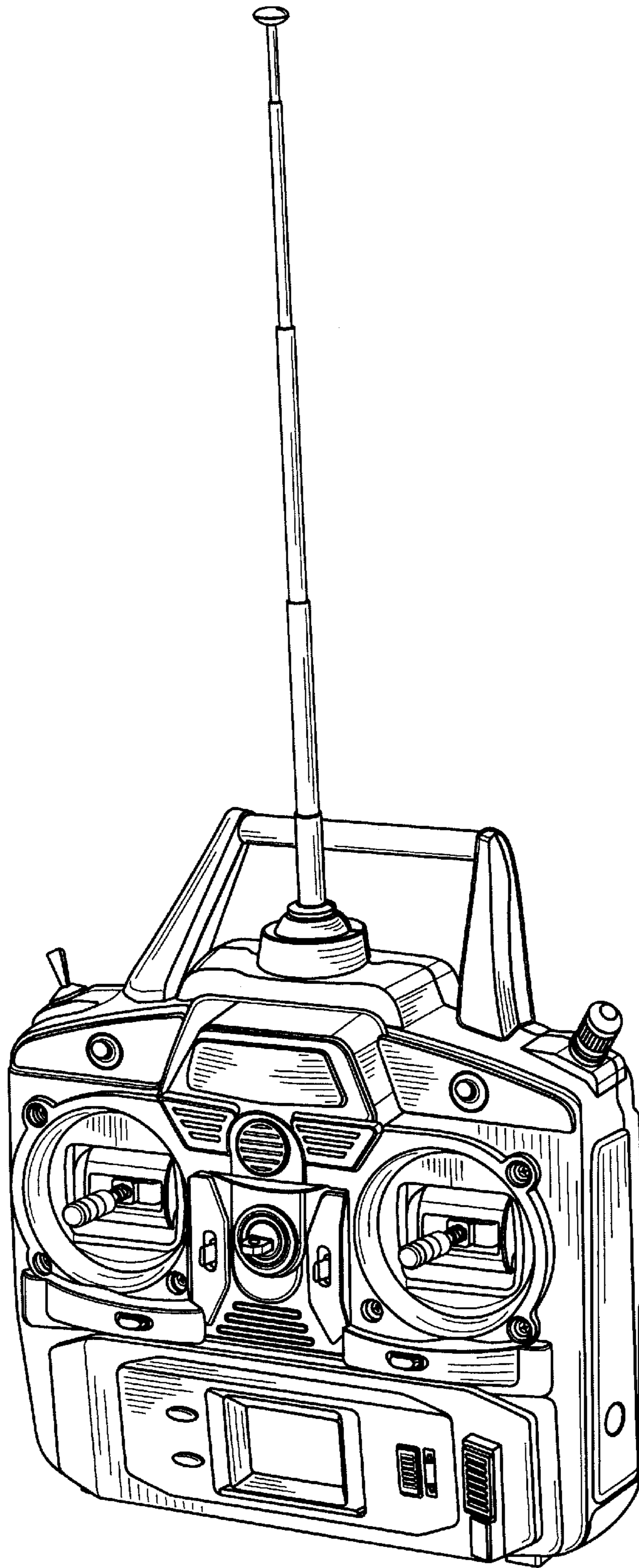

FIG. 9