



US00D514096S

(12) **United States Design Patent**
Storti et al.

(10) **Patent No.:** **US D514,096 S**
(45) **Date of Patent:** **** Jan. 31, 2006**

(54) **BROADBAND ROUTER ENCLOSURE AND BASE**

FOREIGN PATENT DOCUMENTS

GB 2103361 * 8/2001

(75) Inventors: **William J. Storti**, Haverford, PA (US);
Evan A. Groat, Lansdale, PA (US);
Yucheng Jin, Chalfont, PA (US); **Trent H. Punnett**, San Diego, CA (US)

* cited by examiner

Primary Examiner—Charles A. Rademaker
(74) *Attorney, Agent, or Firm*—Esteban A. Rockett

(73) Assignee: **General Instrument Corporation**,
Horsham, PA (US)

(57) **CLAIM**

(**) Term: **14 Years**

The ornamental design for a broadband router enclosure and base, as shown and described.

(21) Appl. No.: **29/200,220**

DESCRIPTION

(22) Filed: **Feb. 25, 2004**

(51) **LOC (8) Cl.** **14-03**

(52) **U.S. Cl.** **D14/240**

(58) **Field of Classification Search** D14/240,
D14/349, 353, 242, 243, 248, 256, 299, 358,
D14/433, 356, 357; 455/151.1–151.4, 550–575,
455/569.1, 569.2; D13/184, 147, 123, 168;
379/433.01–13, 434, 419, 413.04; 220/4.02

See application file for complete search history.

FIG. 1 is a front perspective view of a broadband router enclosure and base showing our new design; FIG. 2 is a top plan view thereof; FIG. 3 is a bottom plan view thereof; FIG. 4 is a side elevation thereof; FIG. 5 is a side elevation of the side opposite that shown in FIG. 4; FIG. 6 is a front elevation thereof; FIG. 7 is a rear elevation thereof; FIG. 8 is front perspective view of the design shown in FIGS. 1 through 7 in an alternate environment; FIG. 9 is a top plan view thereof; FIG. 10 is a bottom plan view thereof; FIG. 11 is a side elevation thereof; FIG. 12 is a side elevation of the side opposite that shown in FIG. 11; FIG. 13 is a front elevation thereof; and, FIG. 14 is a rear elevation thereof.

(56) **References Cited**

U.S. PATENT DOCUMENTS

D339,807 S	*	9/1993	Tattari et al.	D14/240
D401,580 S	*	11/1998	Goto	D14/155
D413,893 S	*	9/1999	Luzbetak et al.	D14/240
D416,023 S	*	11/1999	Du	D14/242
6,085,925 A	*	7/2000	Chung	220/4.02
D434,374 S	*	11/2000	Ko	D13/123
D452,233 S	*	12/2001	Kubik et al.	D14/242
6,510,226 B1	*	1/2003	Thomann et al.	379/413.04
D470,839 S	*	2/2003	Tuhkanen	D14/240
D473,221 S	*	4/2003	Gargani et al.	D14/240
D490,404 S	*	5/2004	Chan	D14/240

The portions drawn in broken lines are shown for illustrative purposes only and do not form part of the claimed design. The broken line showing of environment in the figure drawings is for illustrative purposes only and forms no part of the claimed design.

1 Claim, 9 Drawing Sheets

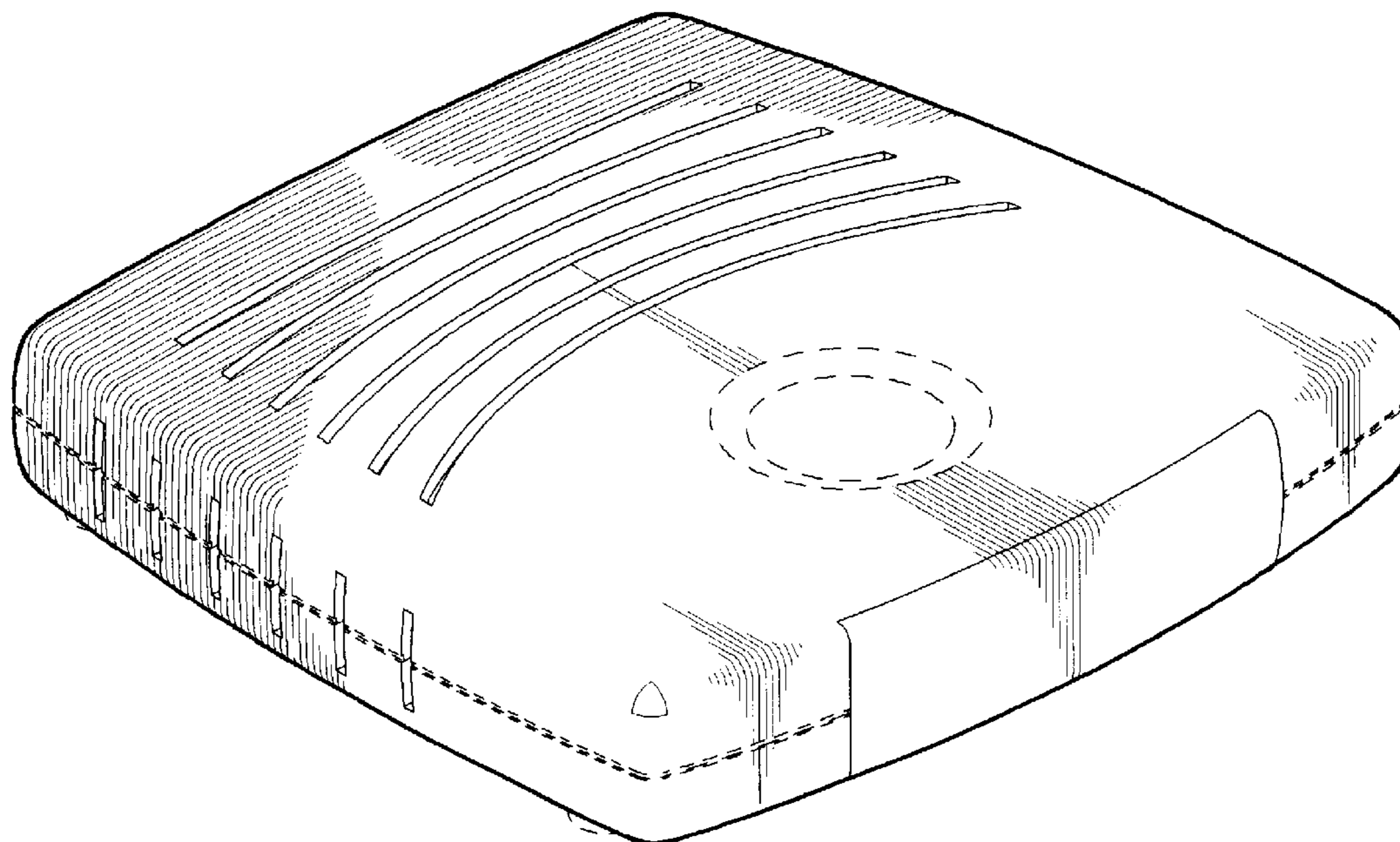

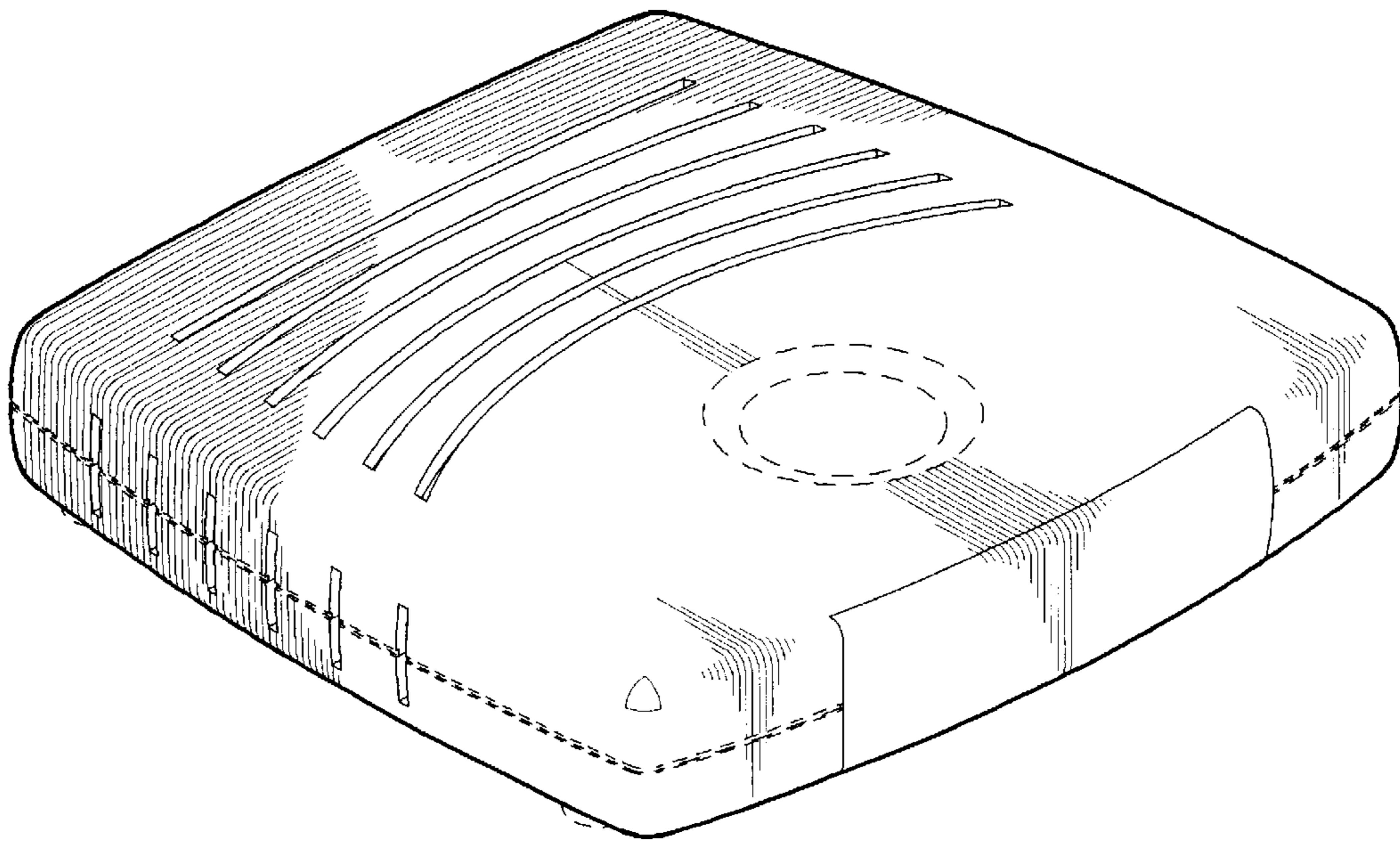

FIG. 1

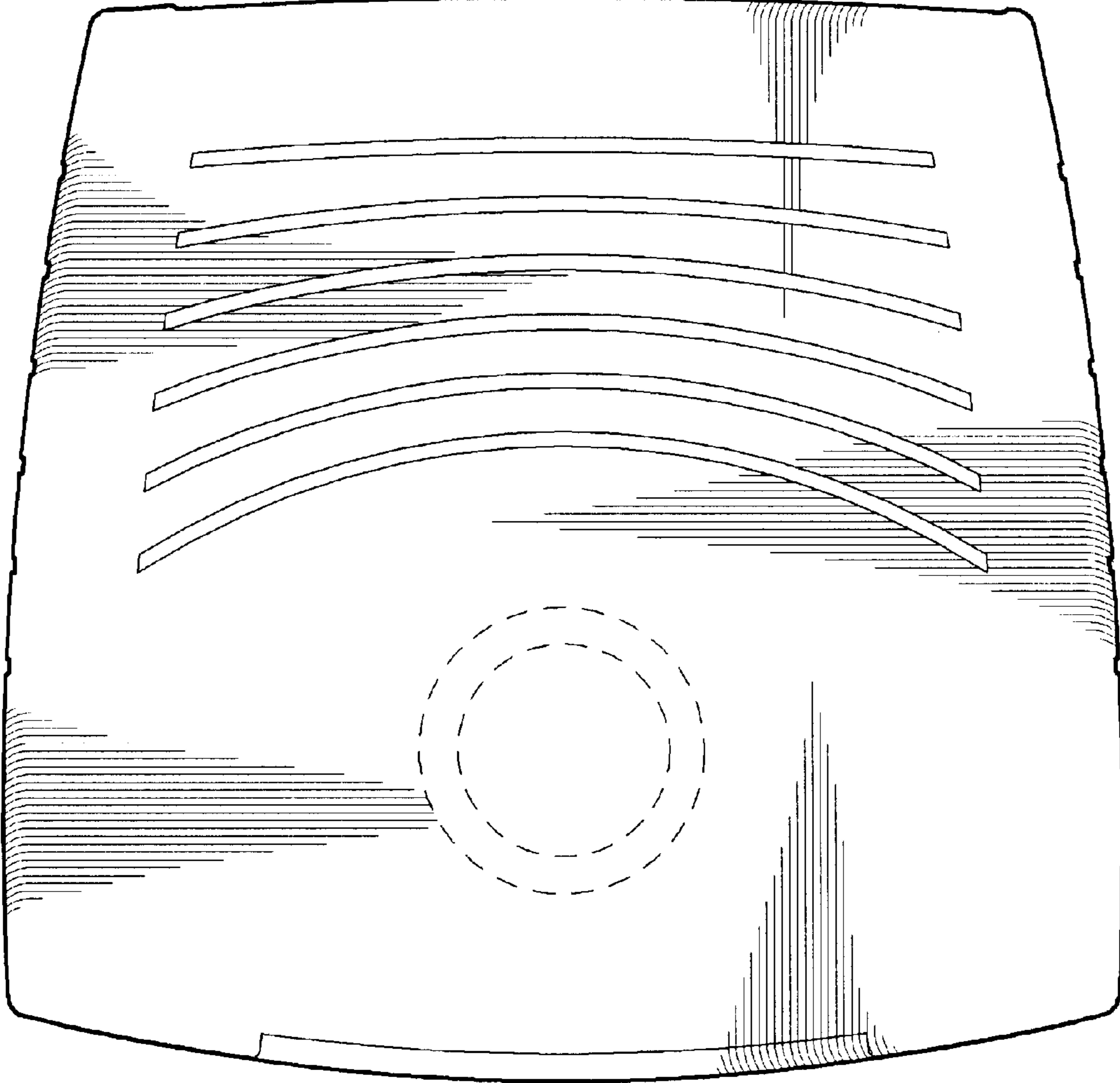

FIG. 2

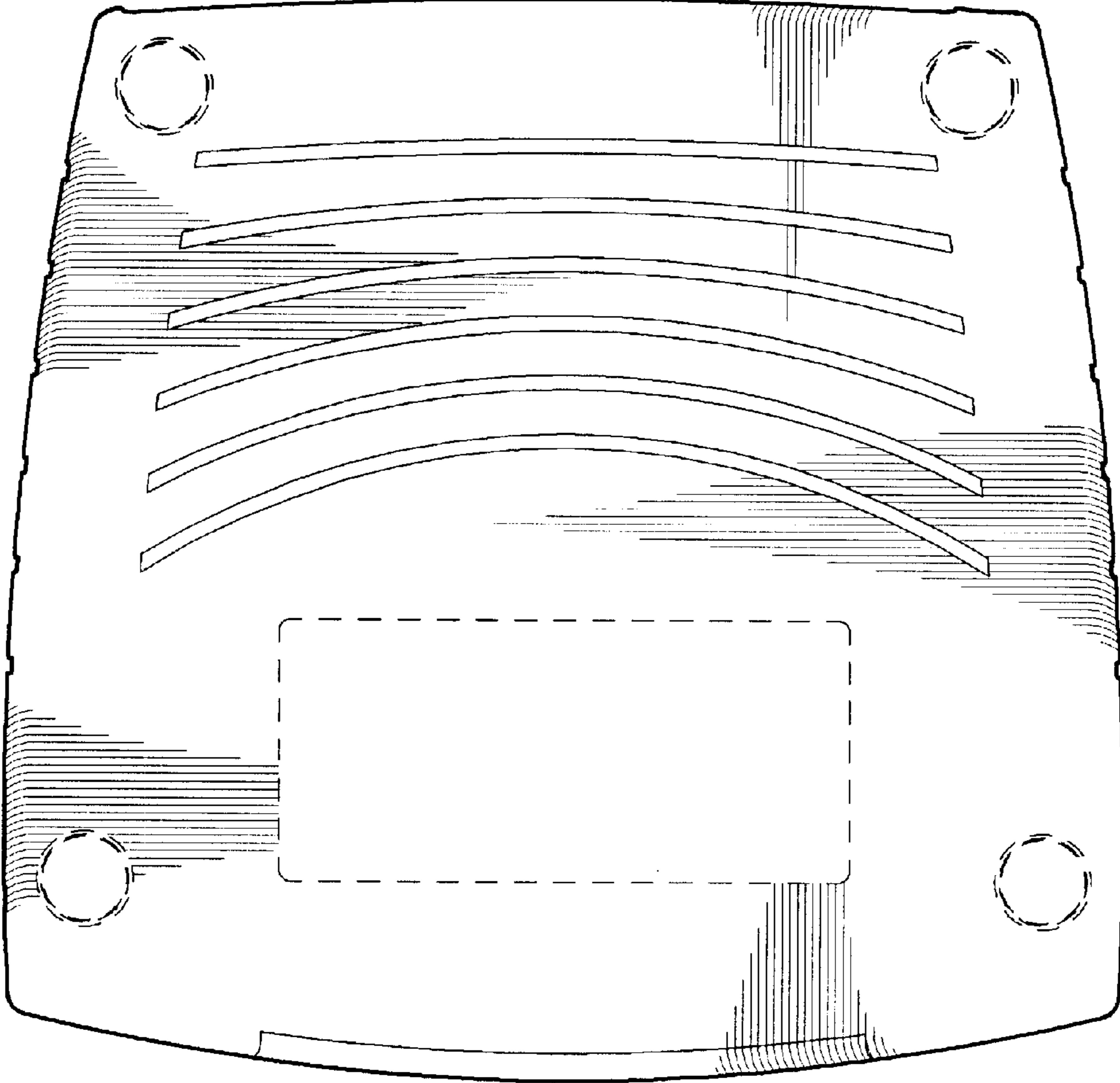

FIG. 3

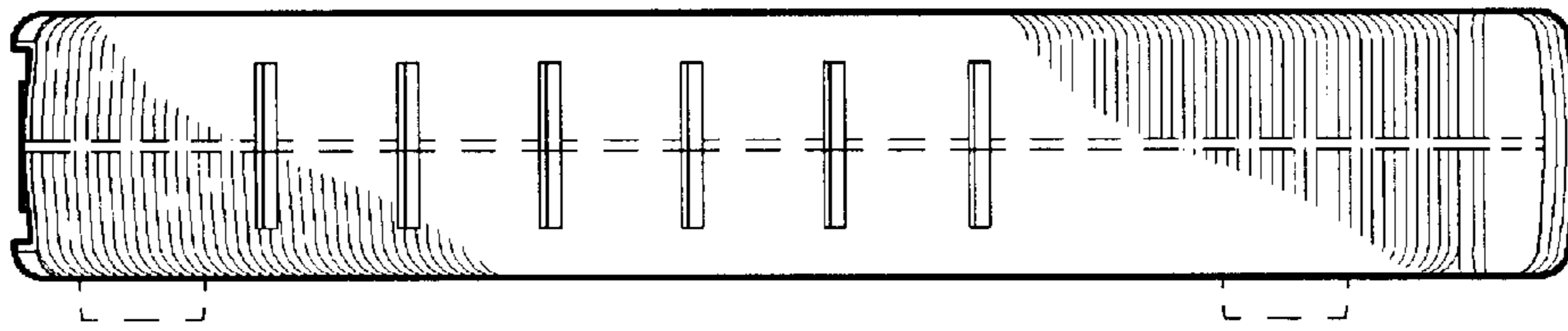

FIG. 4

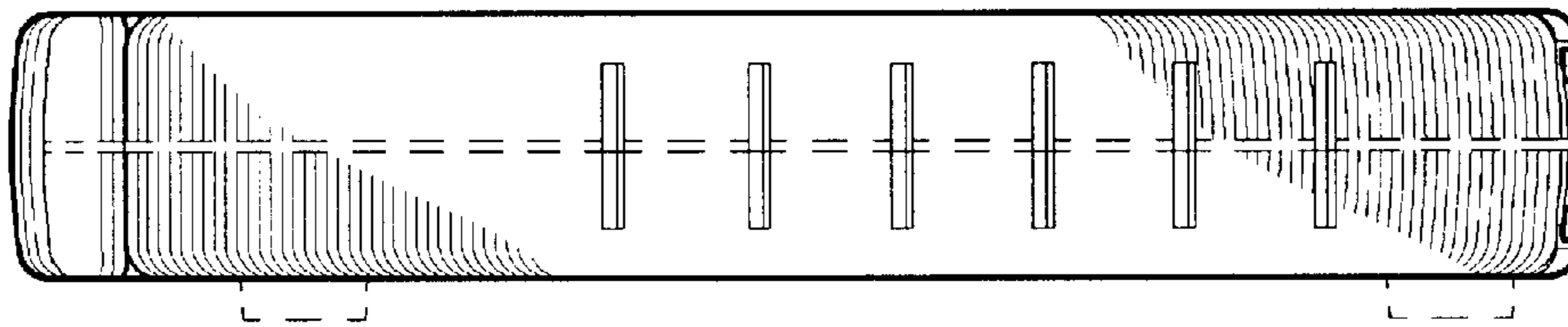

FIG. 5

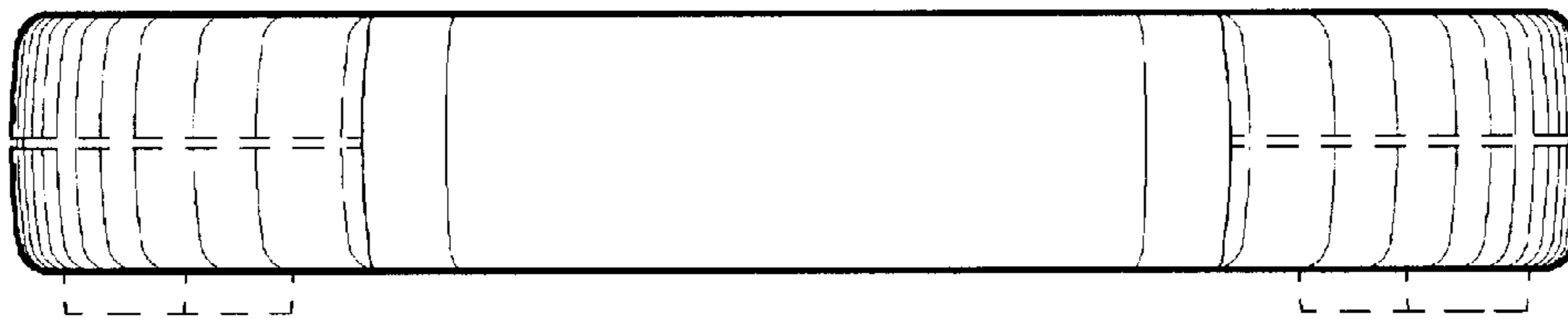

FIG. 6

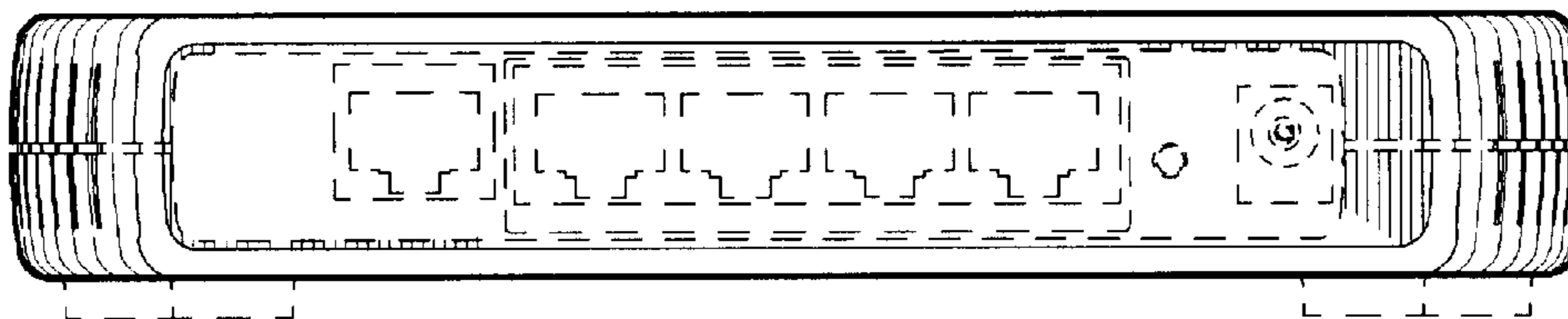

FIG. 7

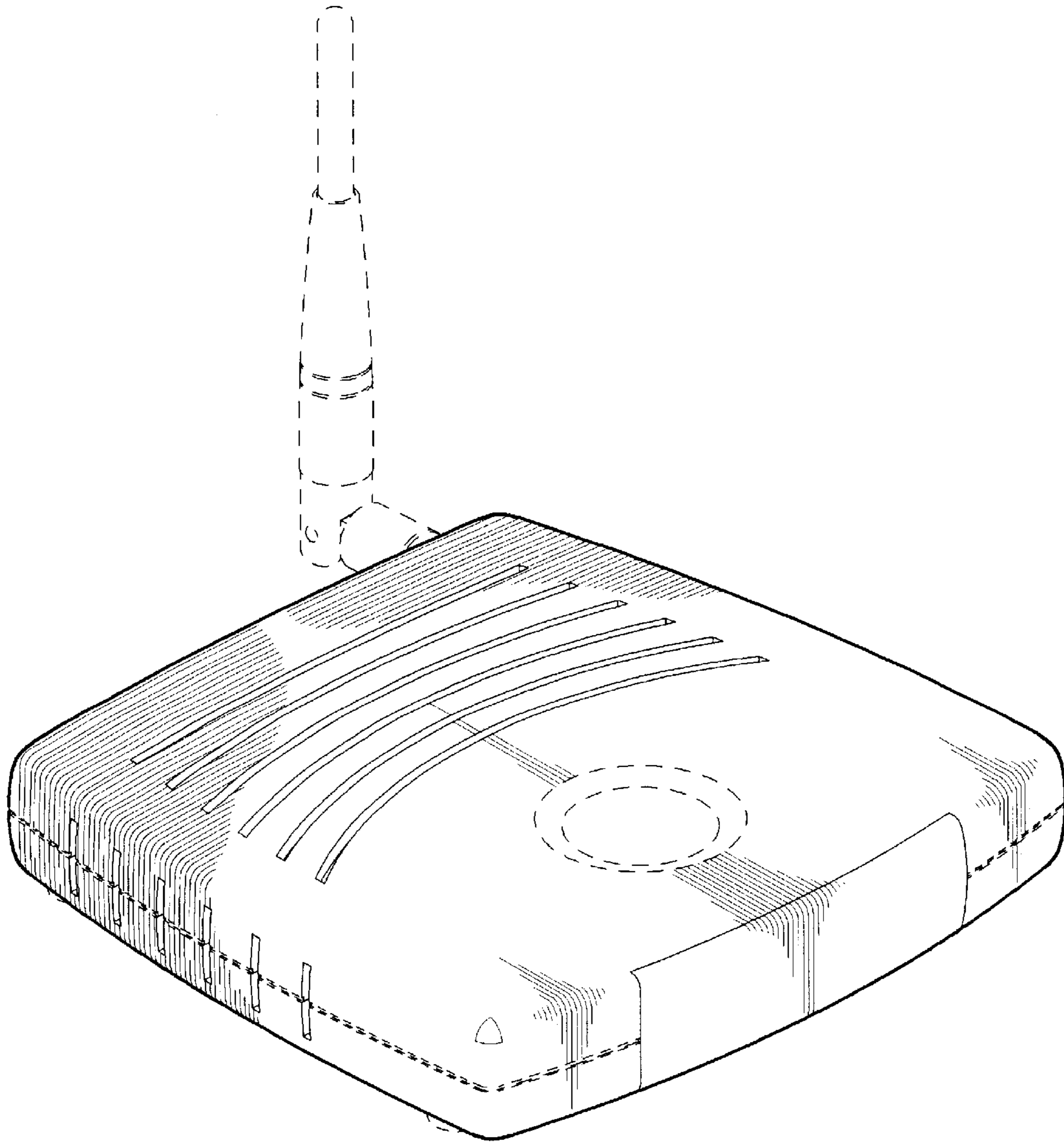

FIG. 8

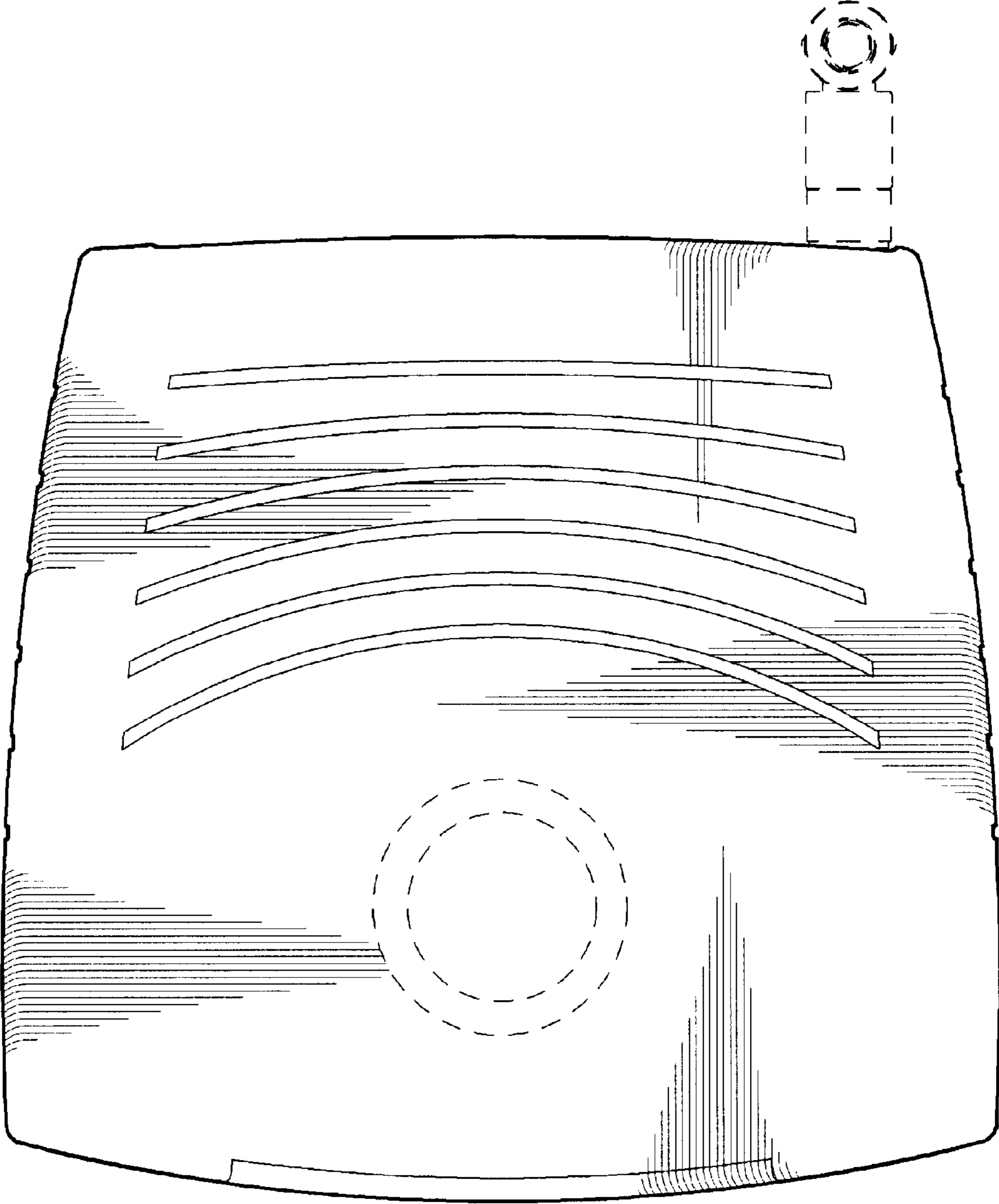

FIG. 9

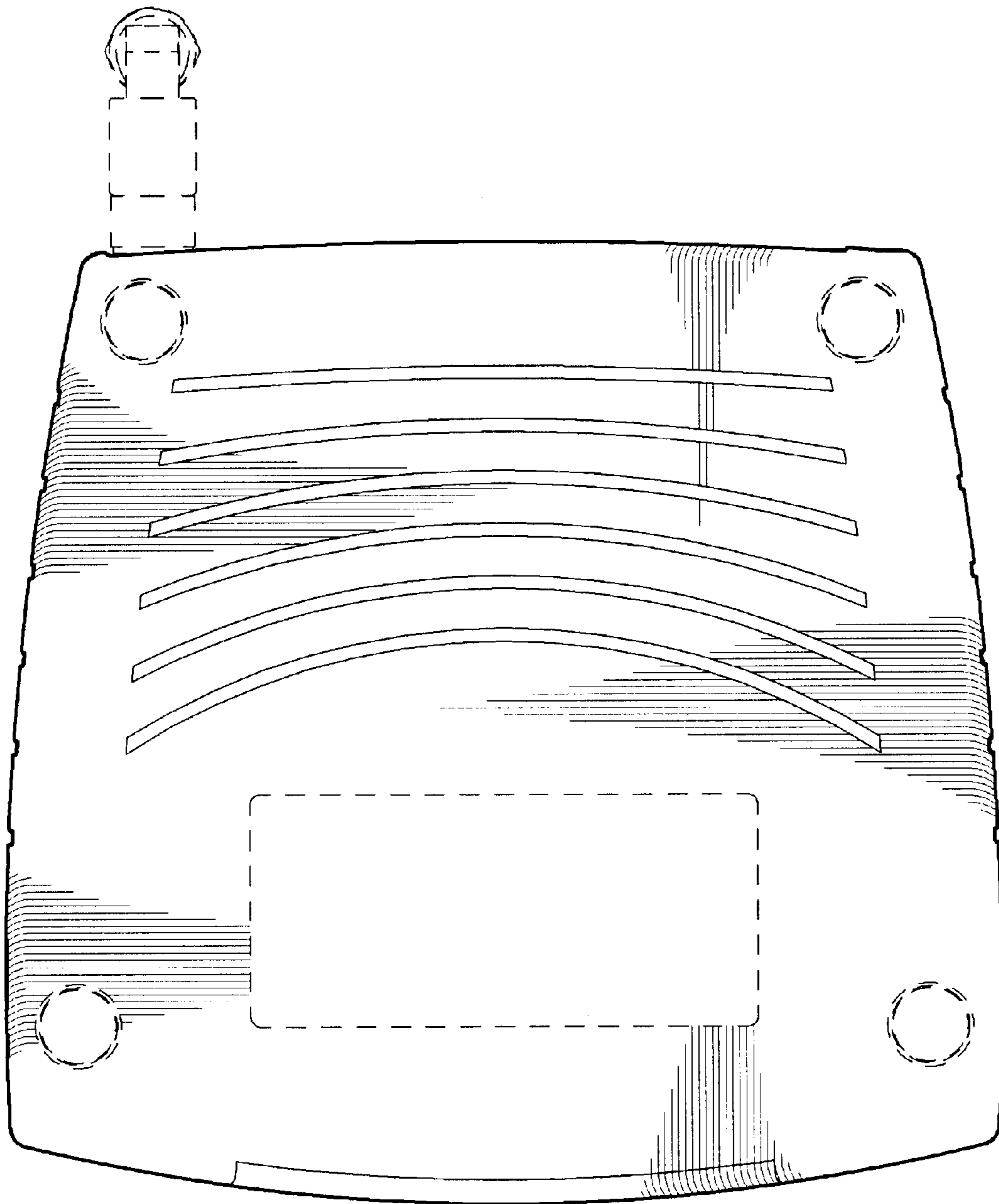

FIG. 10

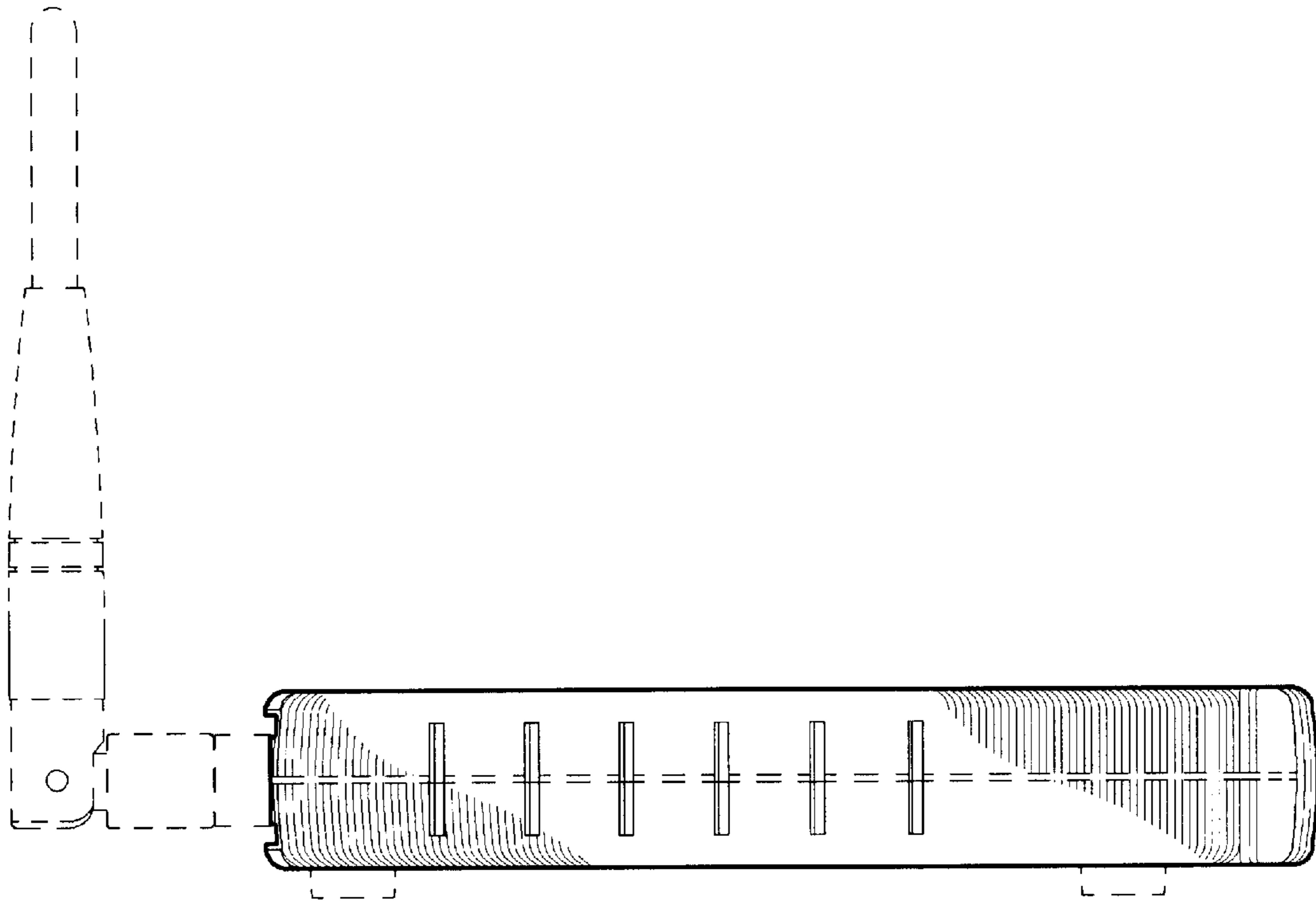

FIG. 11

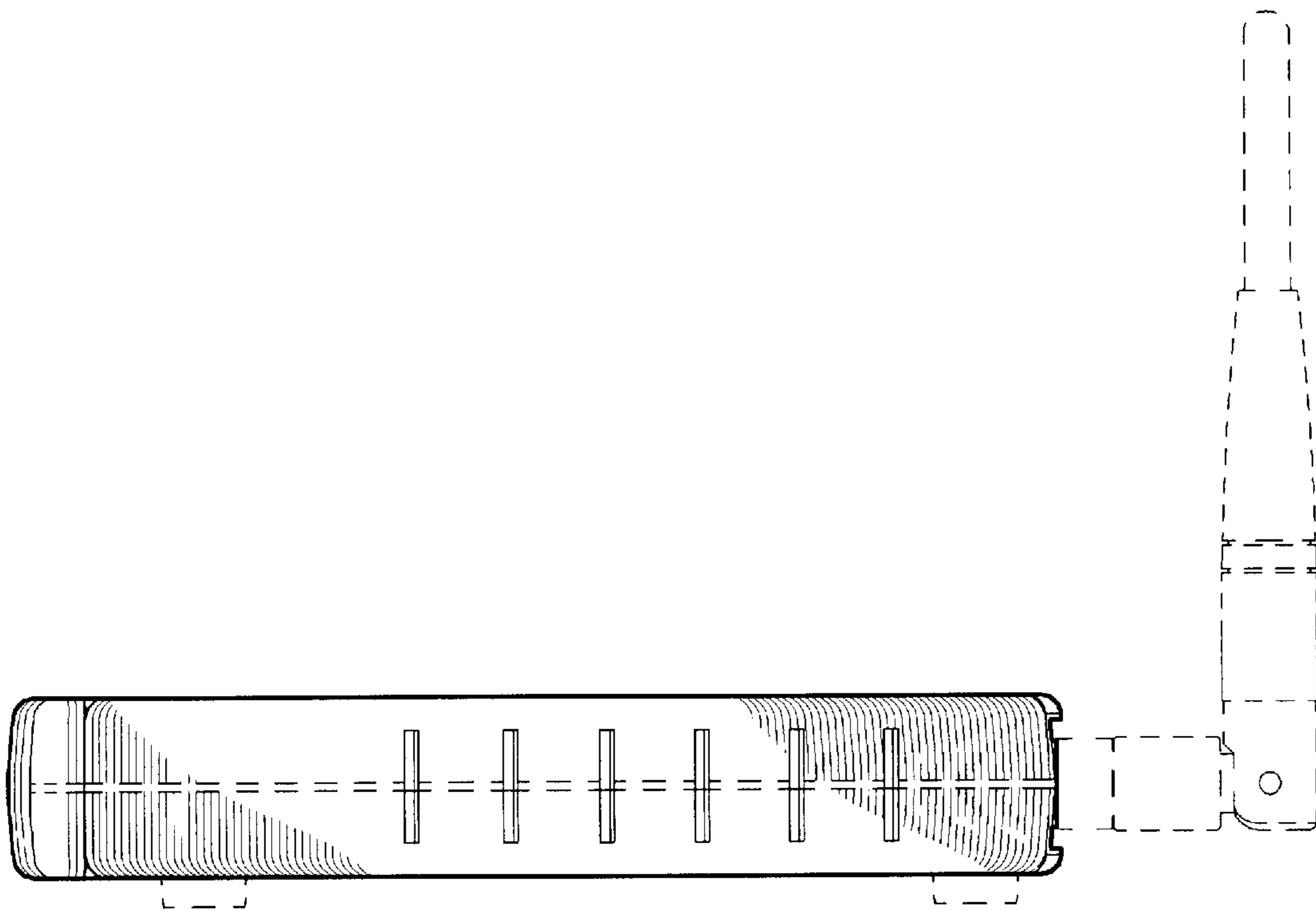

FIG. 12

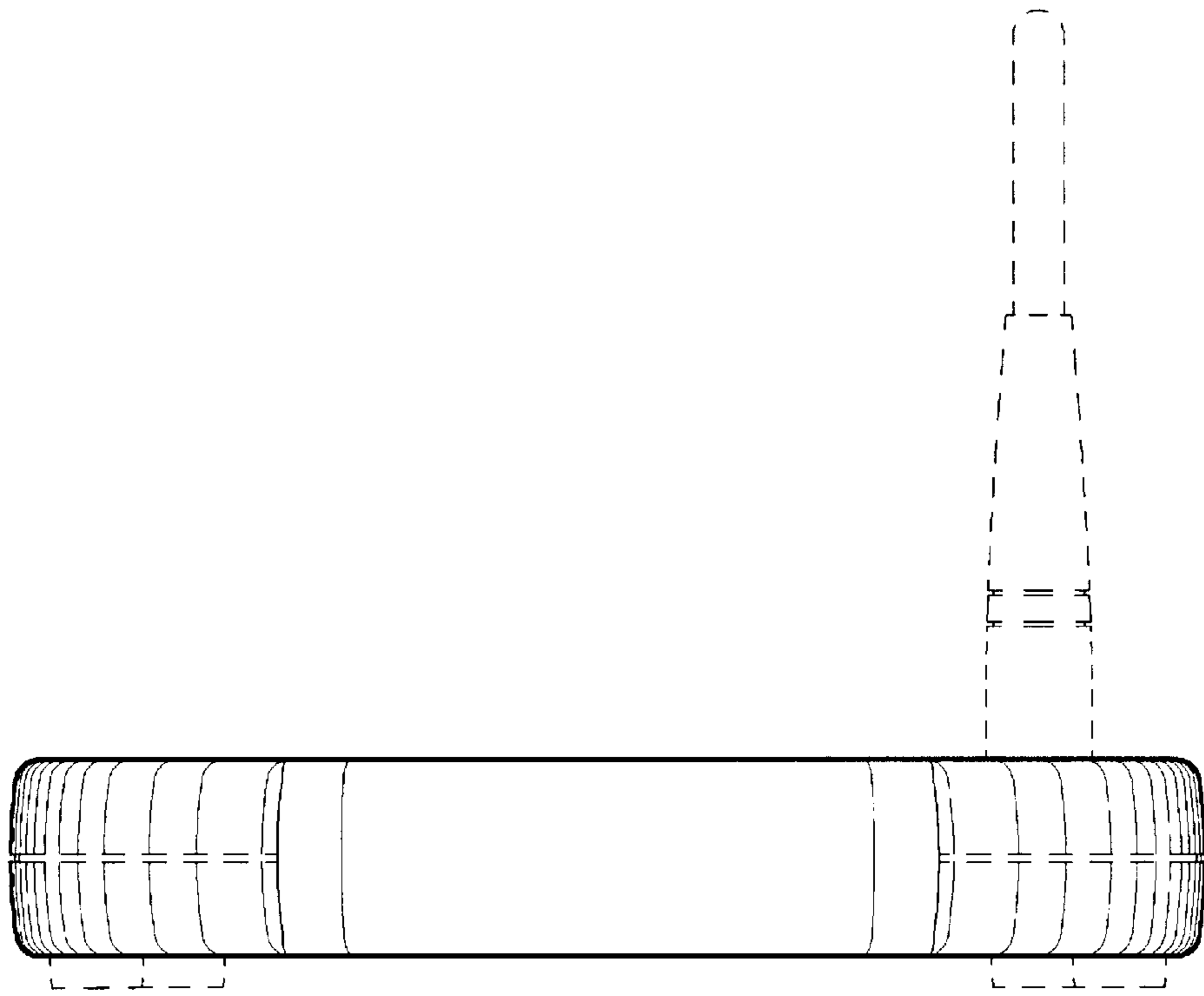

FIG. 13

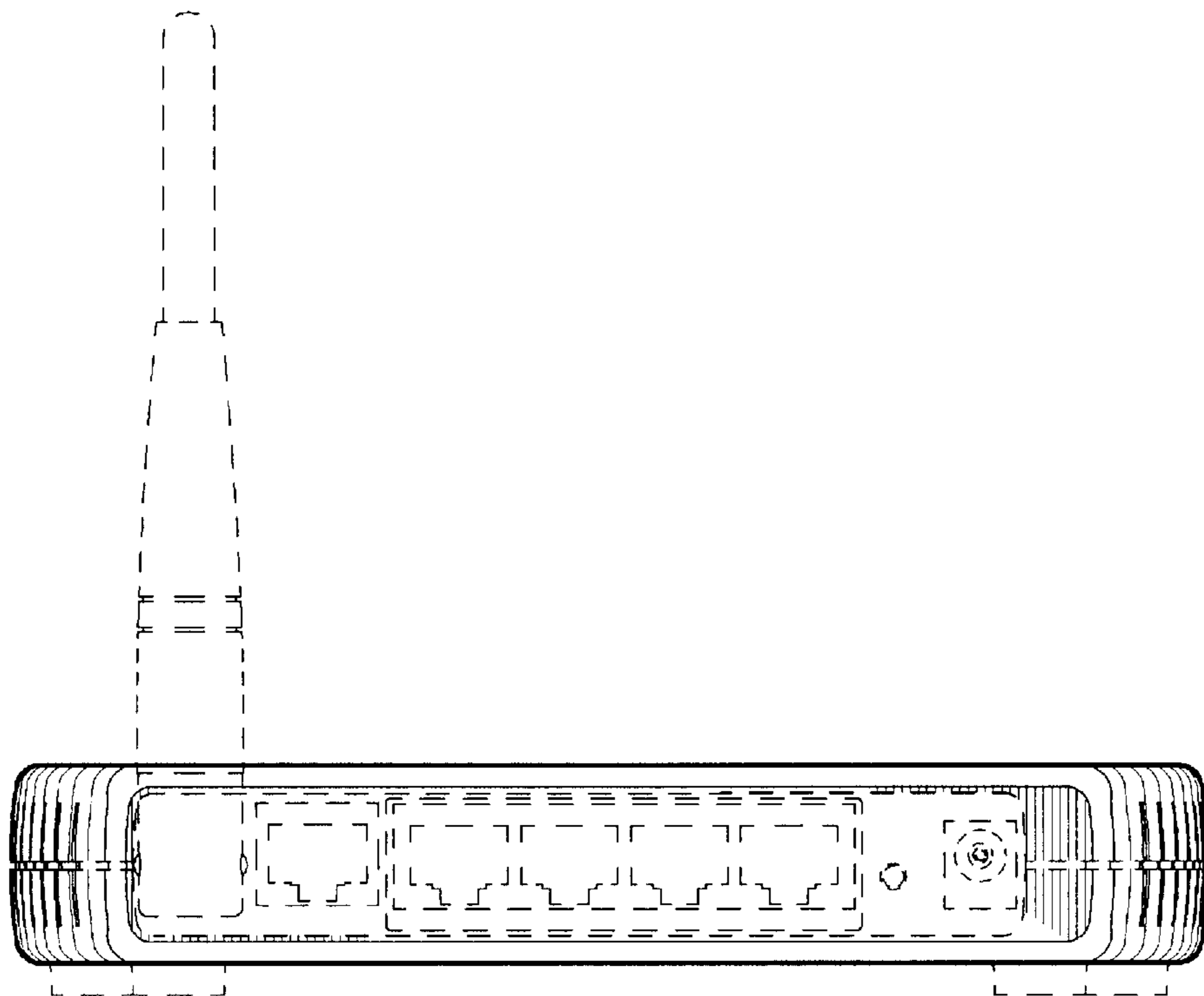

FIG. 14