



US00D514086S

(12) **United States Design Patent**  
**Skulley**

(10) **Patent No.:** **US D514,086 S**  
(45) **Date of Patent:** **\*\* Jan. 31, 2006**

(54) **COMMUNICATIONS HEADSET**

(75) Inventor: **Gerald W. Skulley**, Aptos, CA (US)  
(73) Assignee: **Plantronics, Inc.**, Santa Cruz, CA (US)  
(\*\*) Term: **14 Years**

(21) Appl. No.: **29/220,690**  
(22) Filed: **Jan. 4, 2005**

(51) **LOC (8) Cl.** ..... **14-01**  
(52) **U.S. Cl.** ..... **D14/206**  
(58) **Field of Classification Search** ..... D14/188,  
D14/192, 205-206, 223; 181/129, 130; 379/430,  
379/433; 381/381, 380, 370, 376, 377, 378,  
381/379; D24/110; 2/209  
See application file for complete search history.

(56) **References Cited**

**U.S. PATENT DOCUMENTS**

D377,020 S	*	12/1996	Bungardt et al.	.....	D14/205
D394,437 S	*	5/1998	Landreth et al.	.....	D14/206
5,793,878 A	*	8/1998	Chang	.....	381/370
6,154,539 A	*	11/2000	Pitel	.....	379/430
D447,472 S	*	9/2001	McGugan	.....	D14/225
D448,749 S	*	10/2001	Weikel et al.	.....	D14/206
D482,019 S	*	11/2003	Petersen et al.	.....	D14/206
D488,146 S	*	4/2004	Minto	.....	D14/206
D494,957 S	*	8/2004	Rath et al.	.....	D14/206
D498,470 S	*	11/2004	Skulley et al.	.....	D14/206

\* cited by examiner

*Primary Examiner*—Paula A. Greene  
(74) *Attorney, Agent, or Firm*—Peter Hsieh

(57) **CLAIM**

The ornamental design for a communications headset, as shown and described.

**DESCRIPTION**

FIG. 1 is an upper front right perspective view of a communications headset, a microphone boom of the communi-

cations headset being shown herein an exemplary storage position for purposes of clarity.

FIG. 2 is a front elevational view of the communications headset of FIG. 1.

FIG. 3 is a rear elevational view of the communications headset of FIG. 1.

FIG. 4 is a left side elevational view of the communications headset of FIG. 1.

FIG. 5 is a right side elevational view of the communications headset of FIG. 1.

FIG. 6 is a top plan view of the communications headset of FIG. 1.

FIG. 7 is a bottom plan view of the communications headset of FIG. 1.

FIG. 8 is an upper front right perspective view of a variant of the communications headset of FIG. 1 in which a microphone disposed at the end of the microphone boom is a variant of that shown in FIG. 1.

FIG. 9 is a front elevational view of the communications headset of FIG. 8.

FIG. 10 is a rear elevational view of the communications headset of FIG. 8.

FIG. 11 is a left side elevational view of the communications headset of FIG. 8.

FIG. 12 is a right side elevational view of the communications headset of FIG. 8.

FIG. 13 is a top plan view of the communications headset of FIG. 8; and,

FIG. 14 is a bottom plan view of the communications headset of FIG. 8.

**1 Claim, 6 Drawing Sheets**

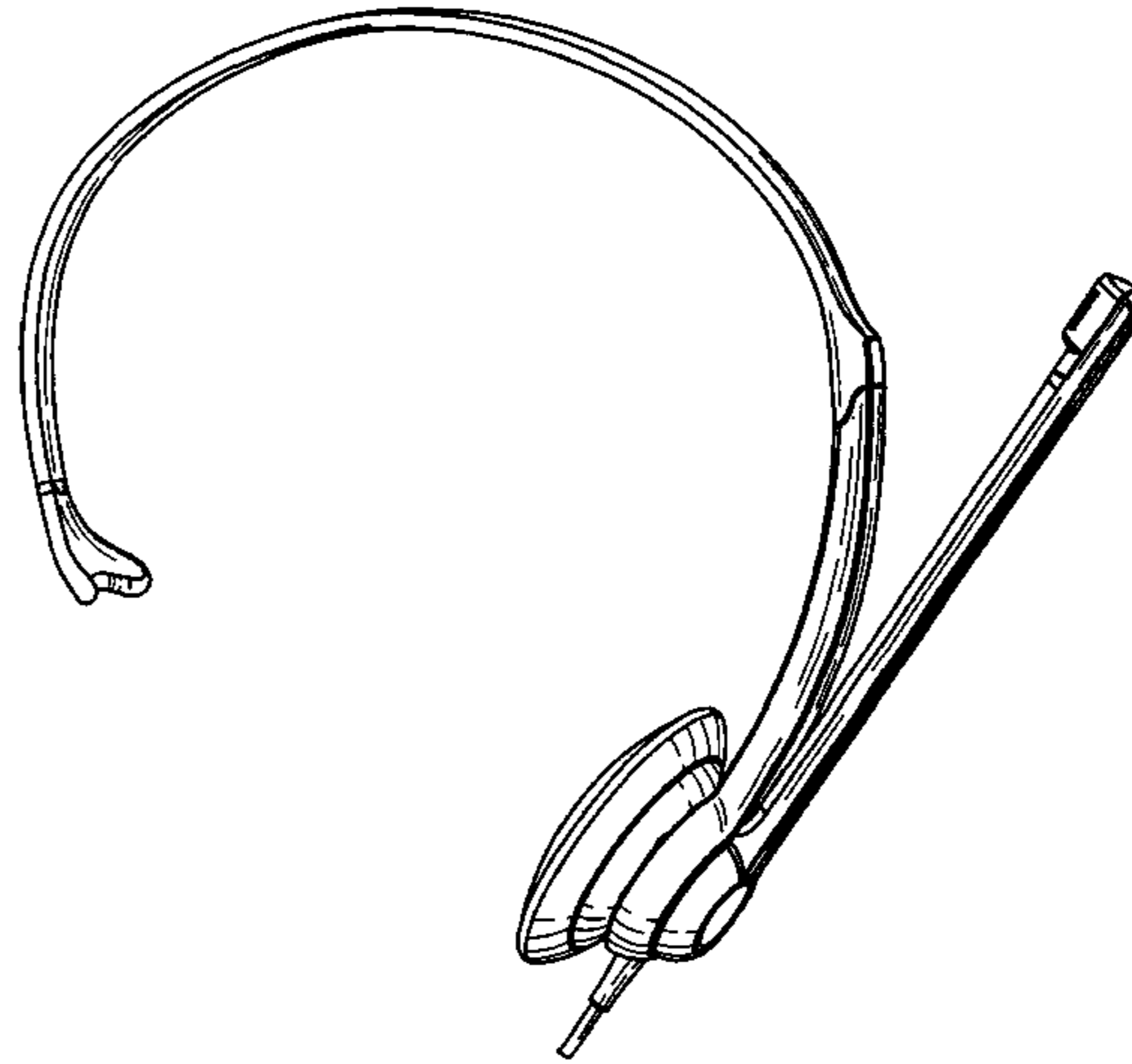
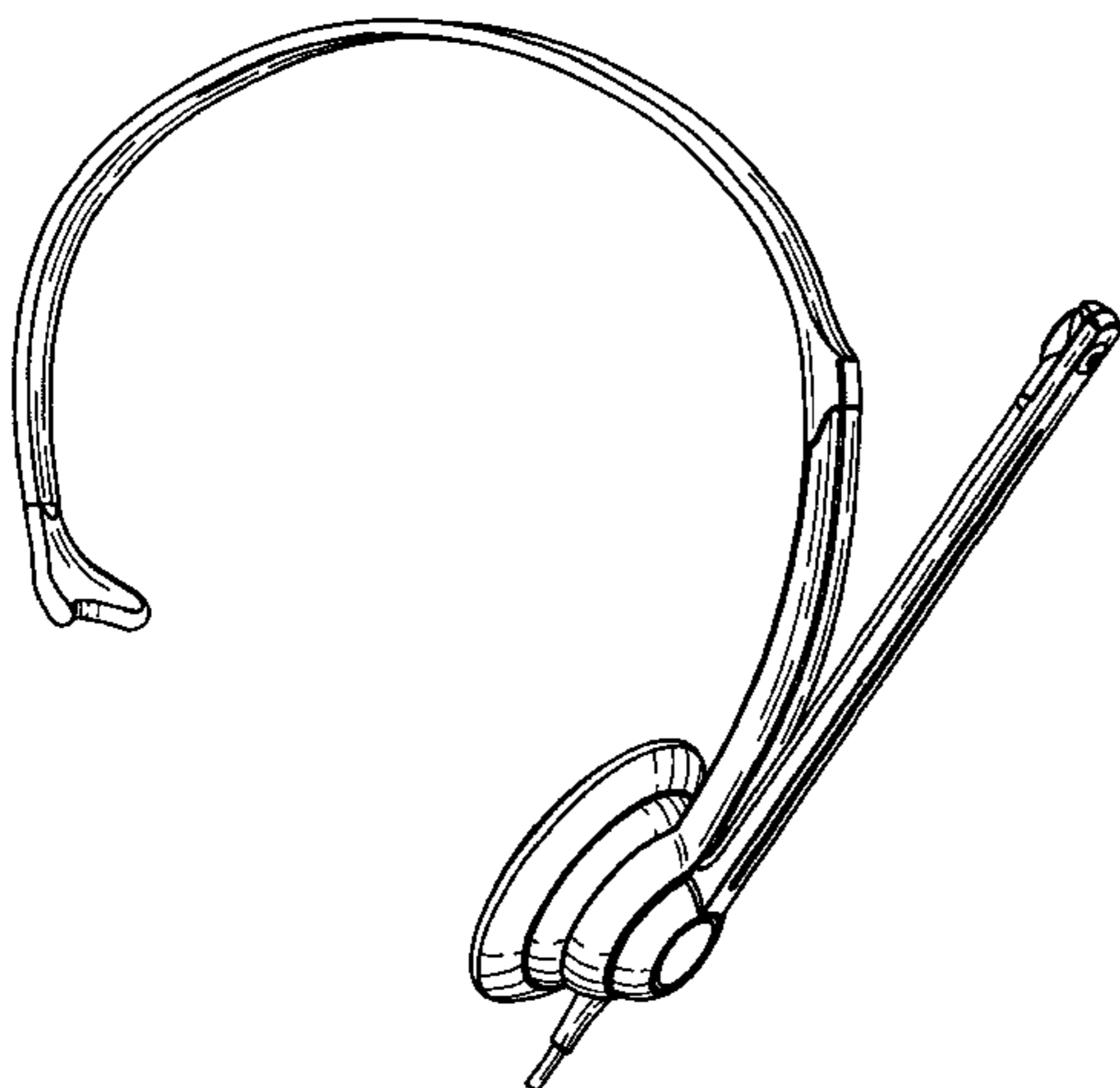

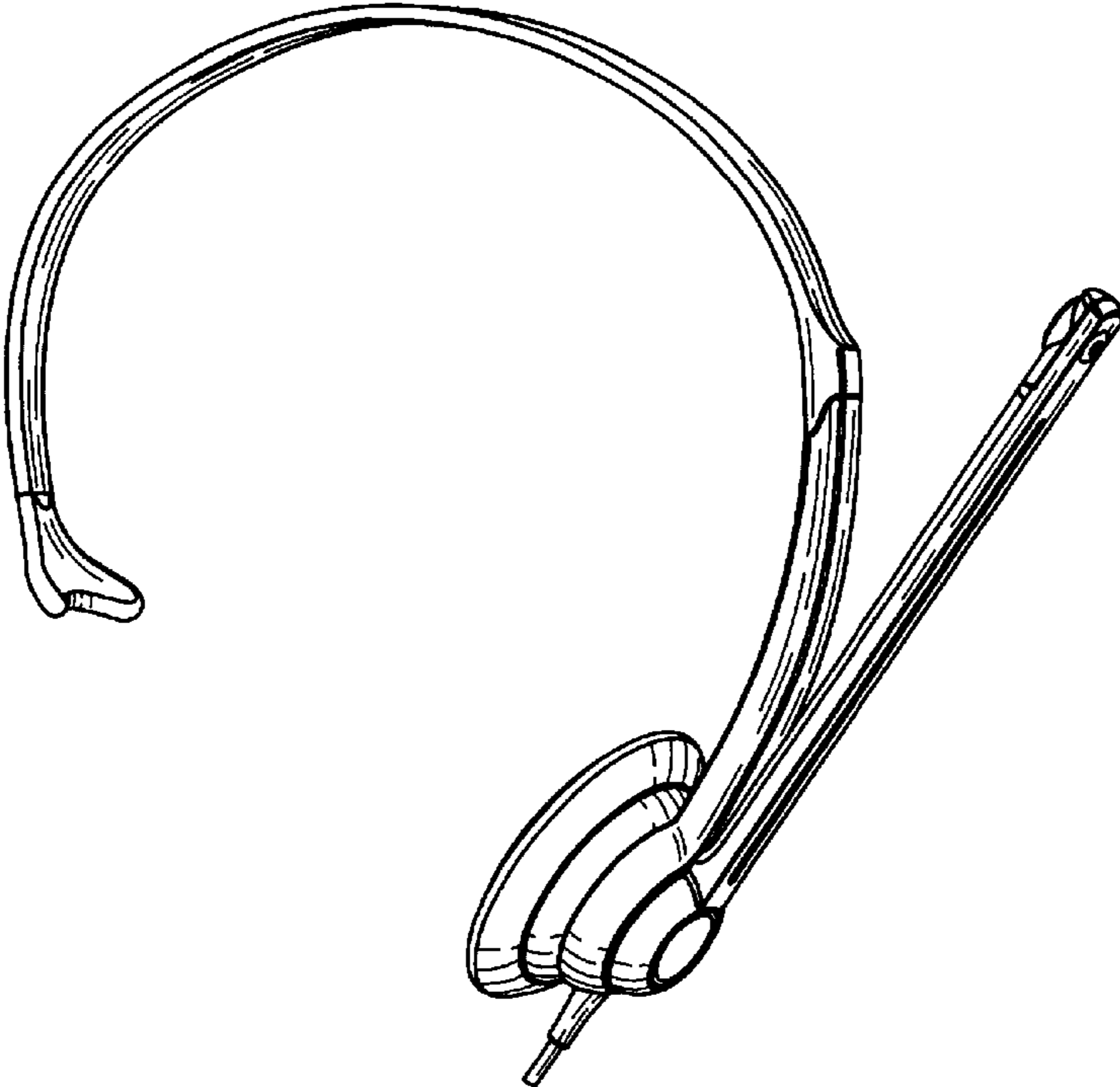

FIG. 1

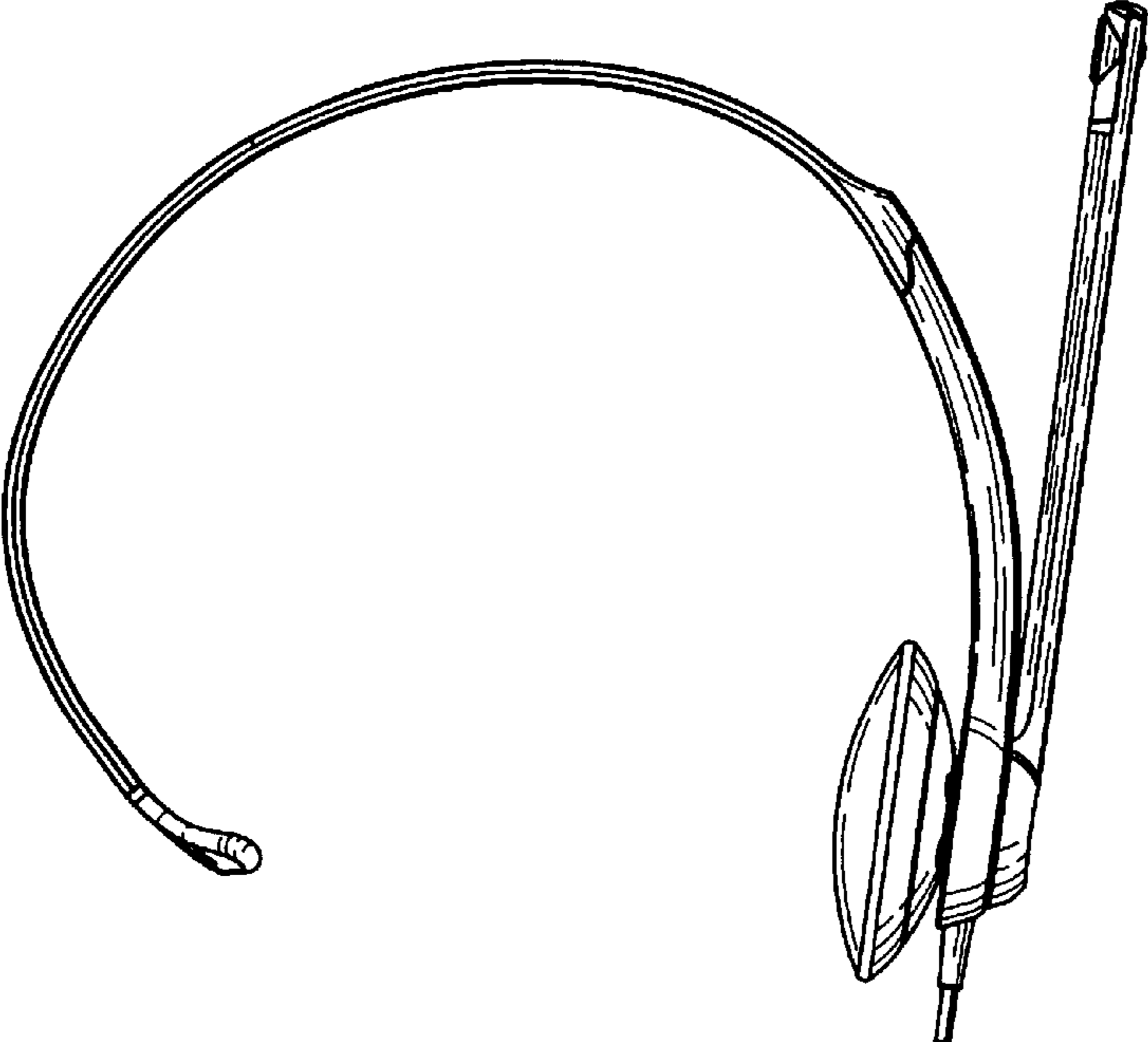
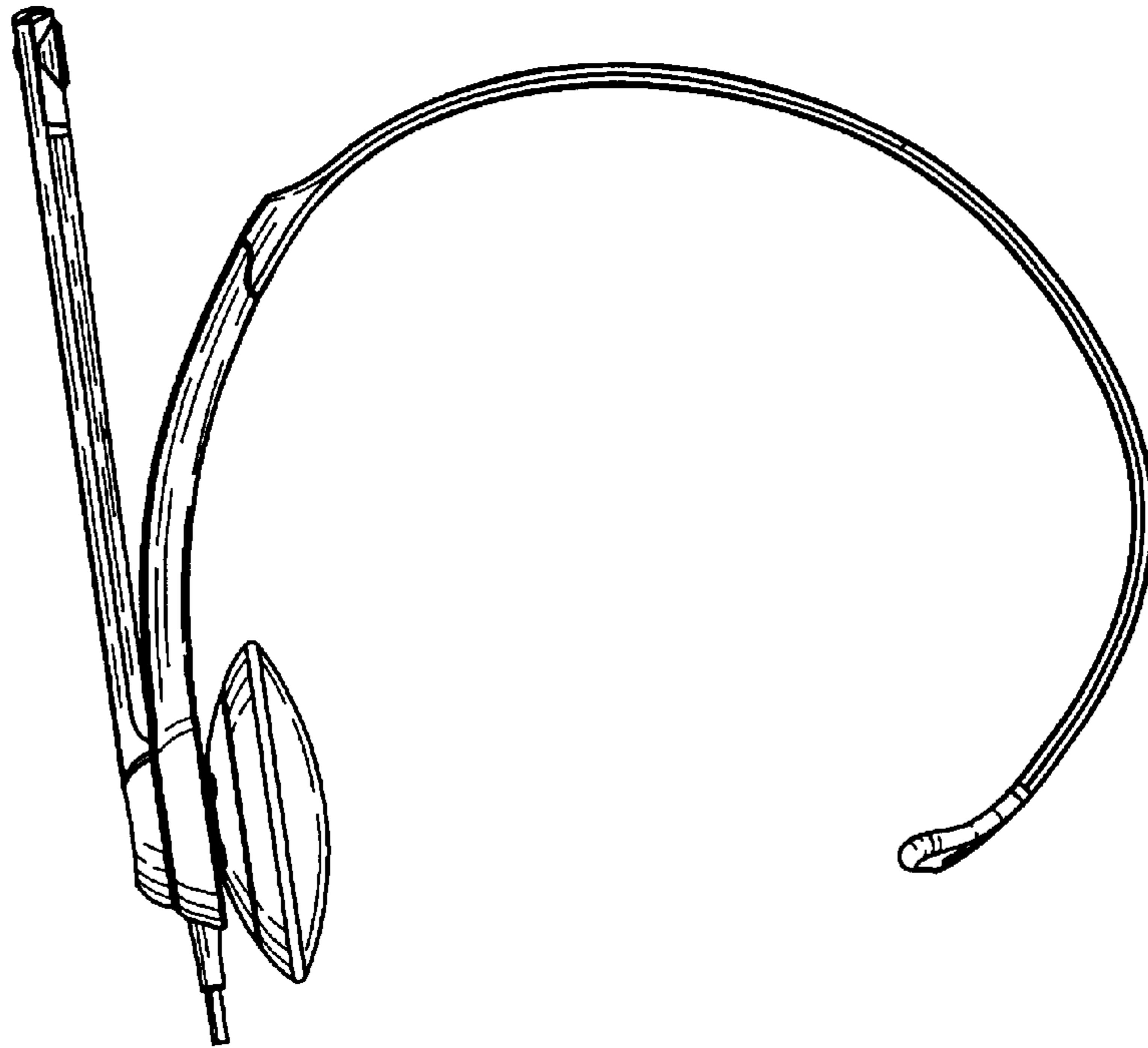
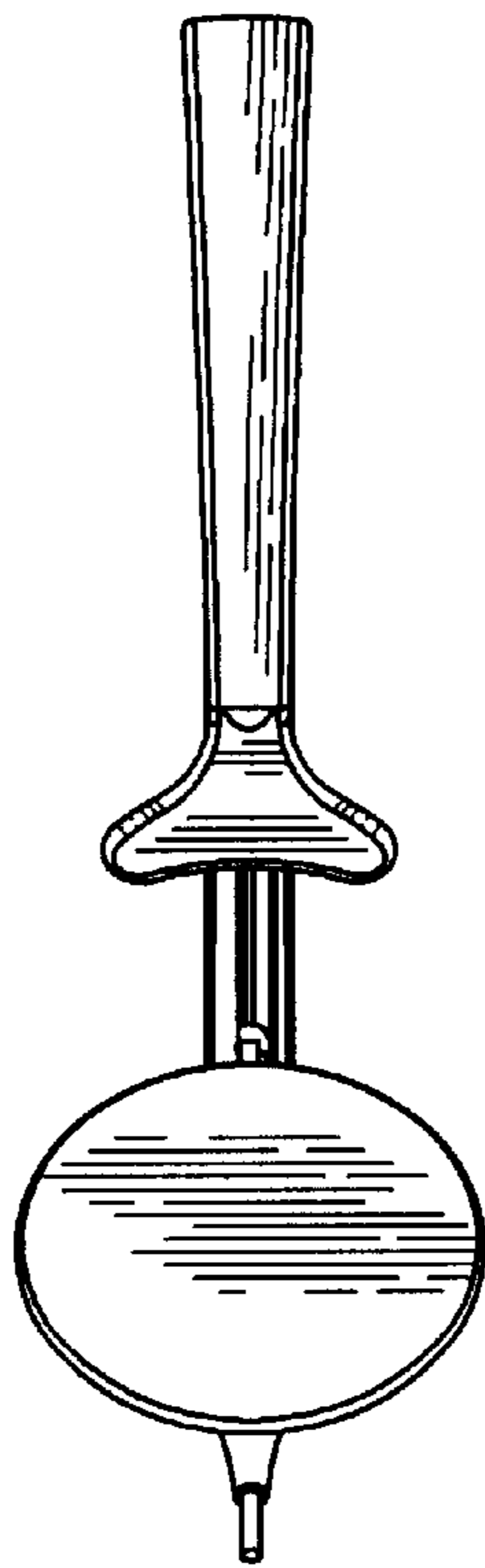

FIG. 2



**FIG. 3**



**FIG. 4**

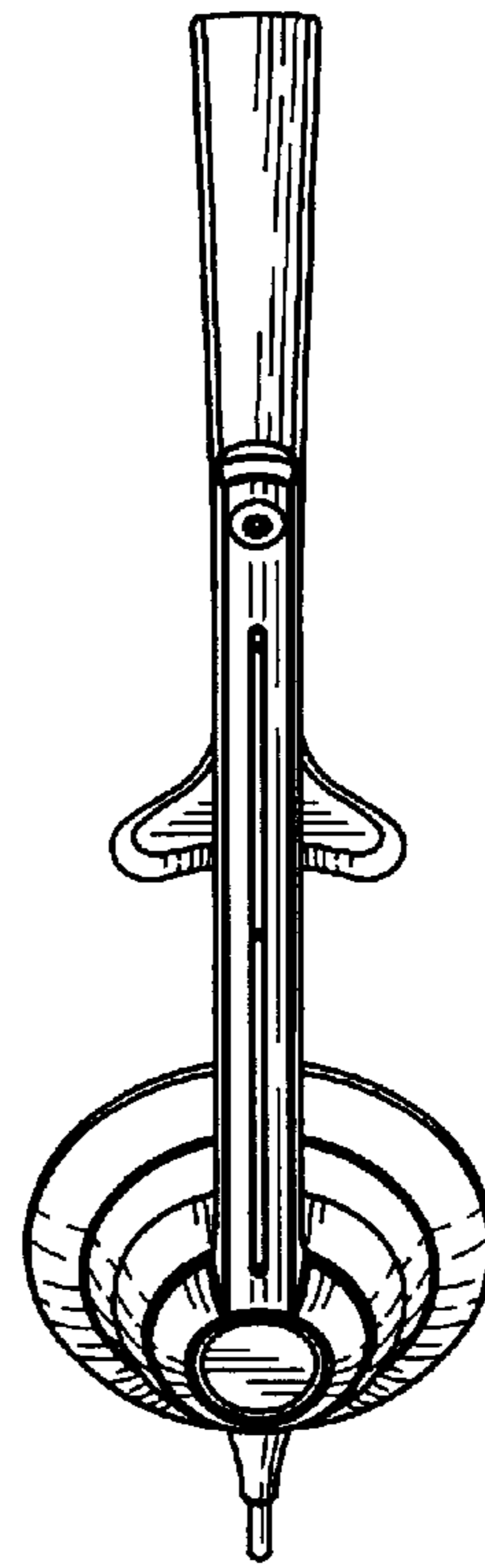

**FIG. 5**

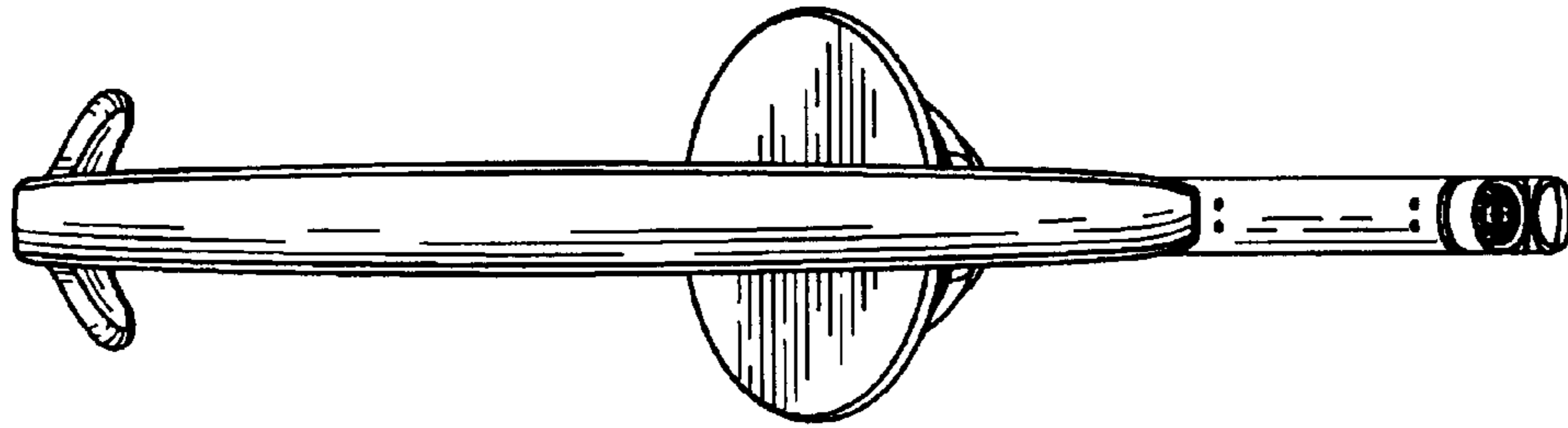

**FIG. 6**

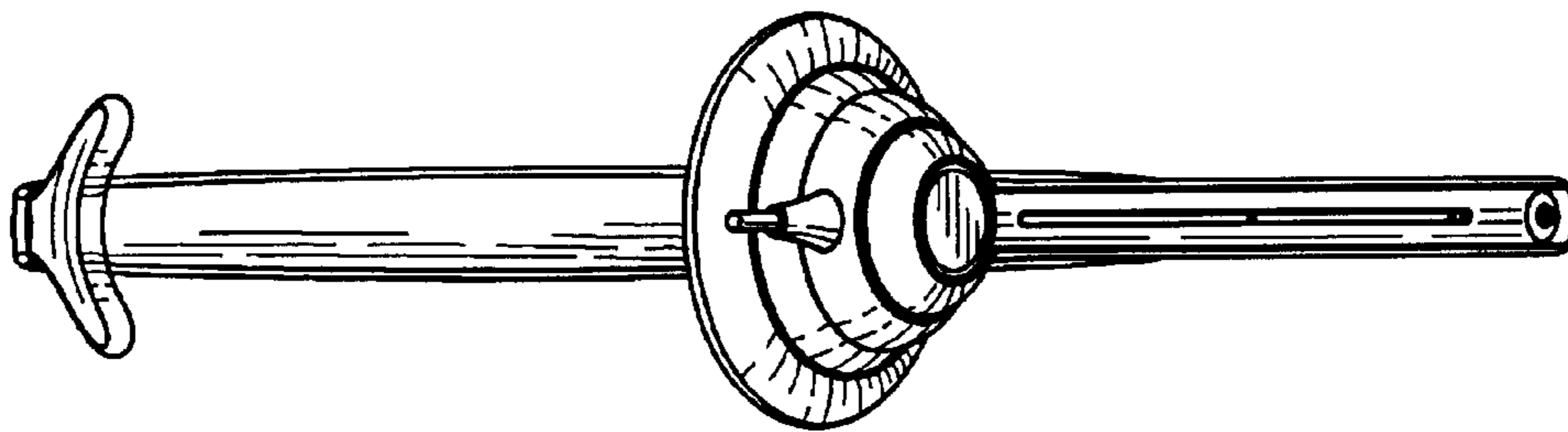

**FIG. 7**

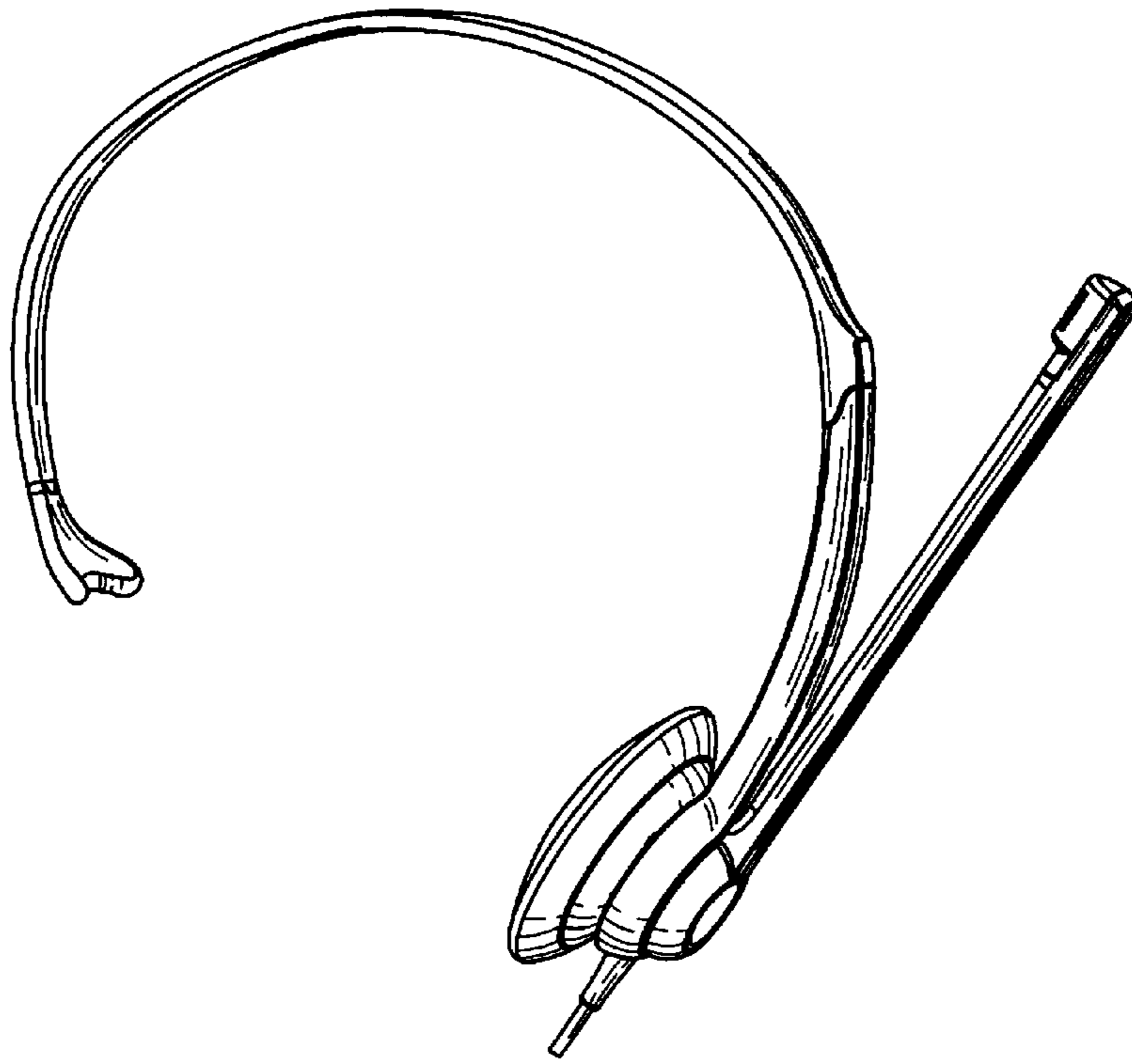

**FIG. 8**

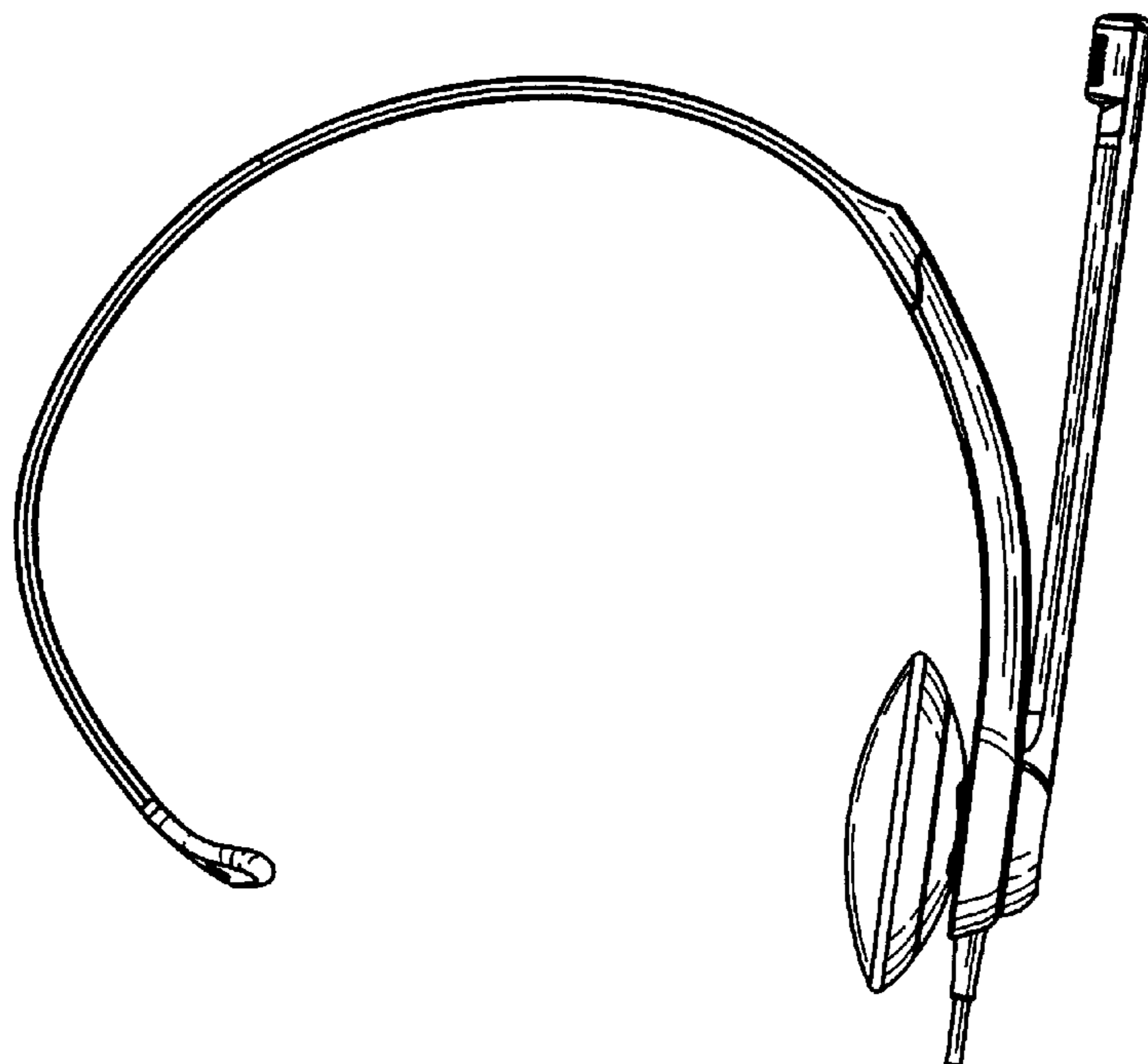

**FIG. 9**

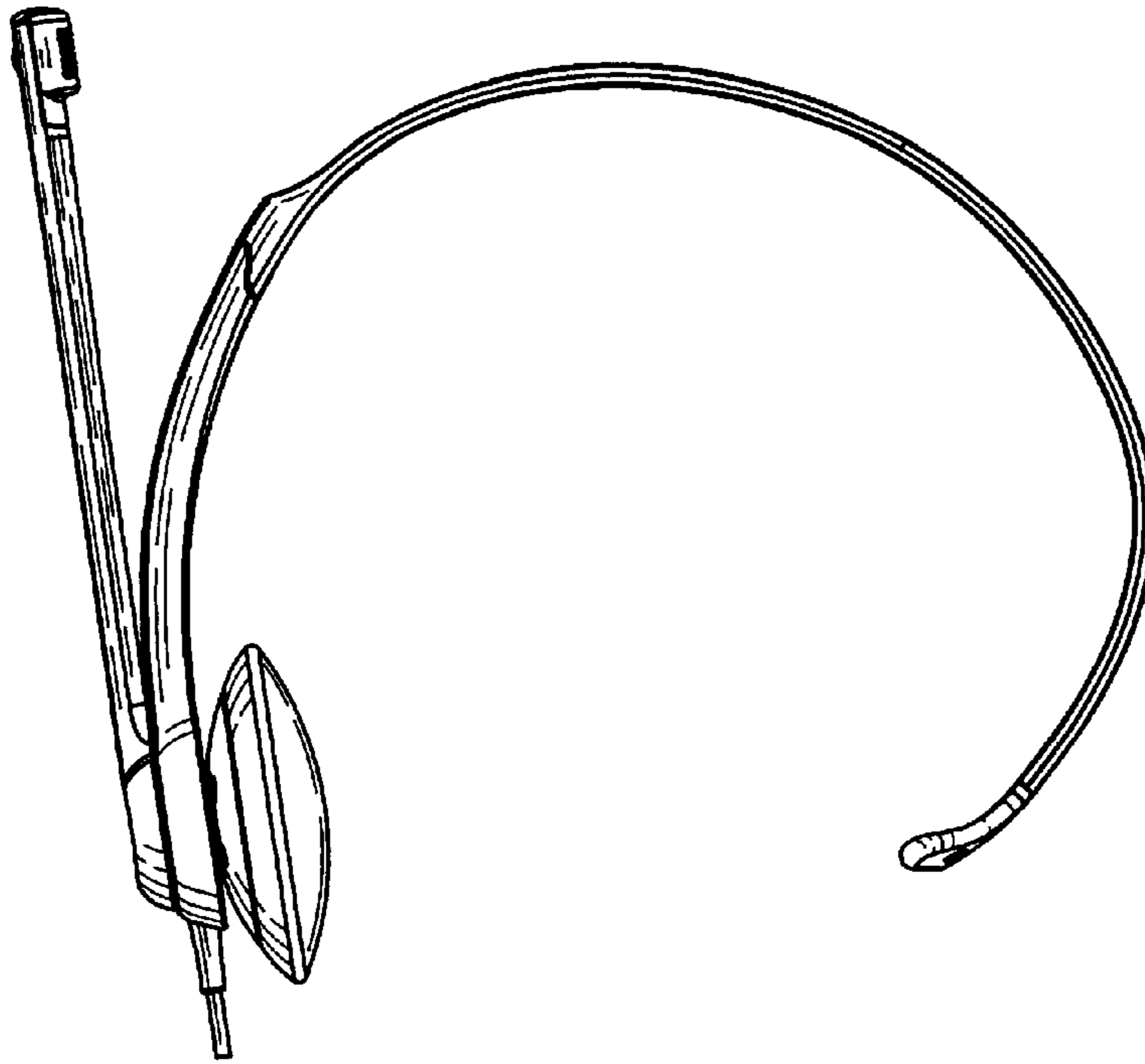

**FIG. 10**

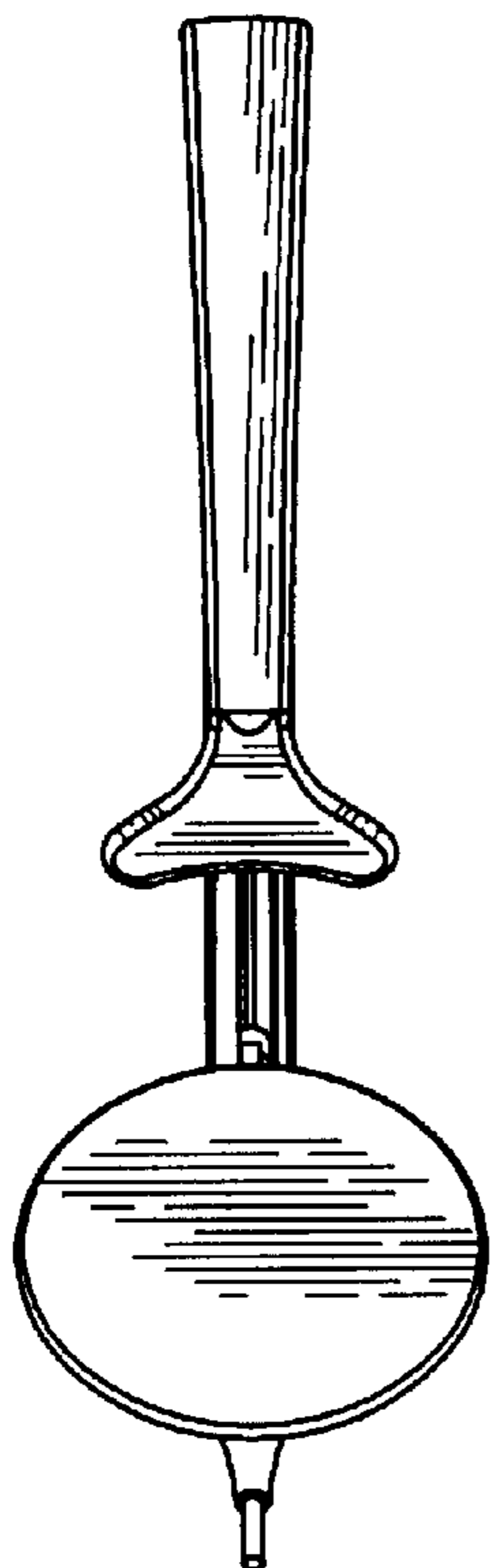

**FIG. 11**

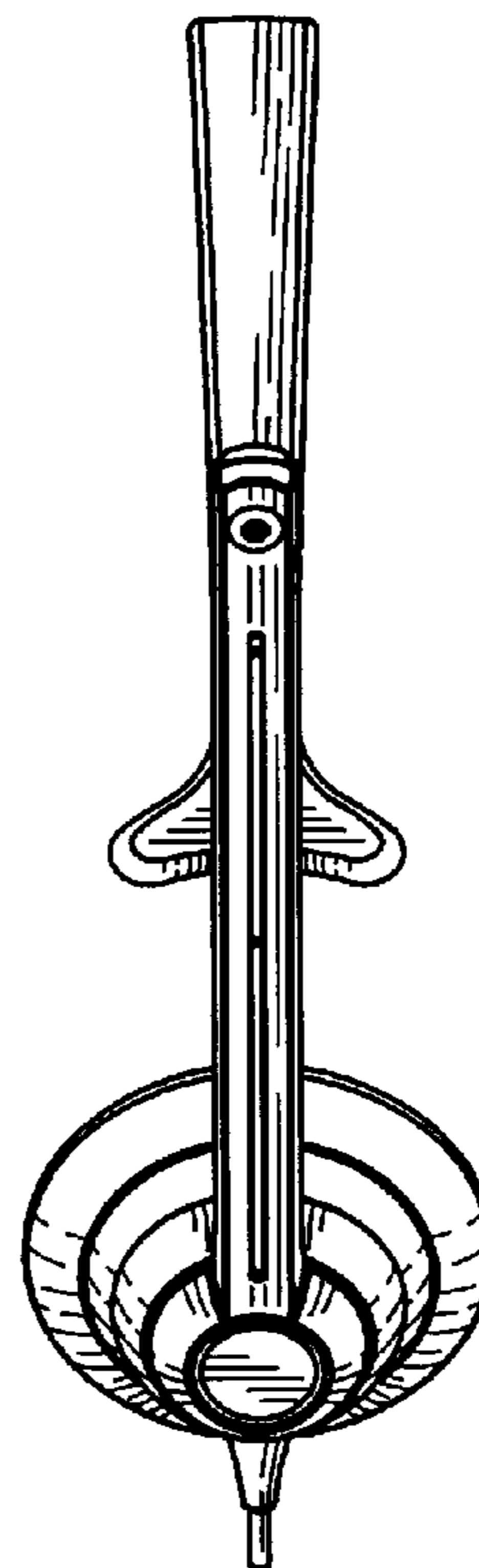

**FIG. 12**

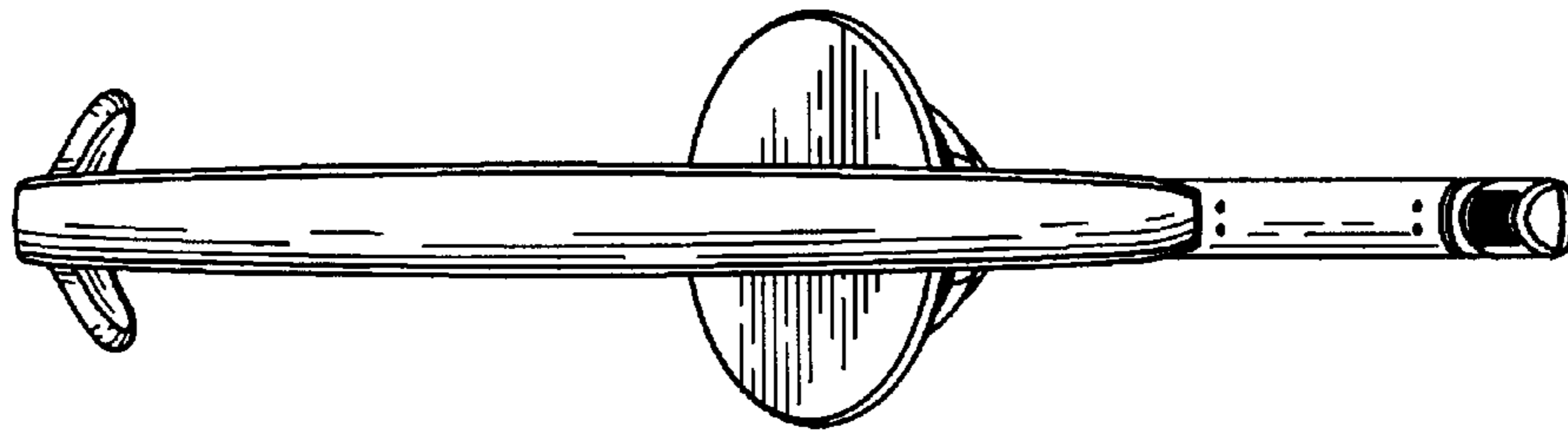

**FIG. 13**

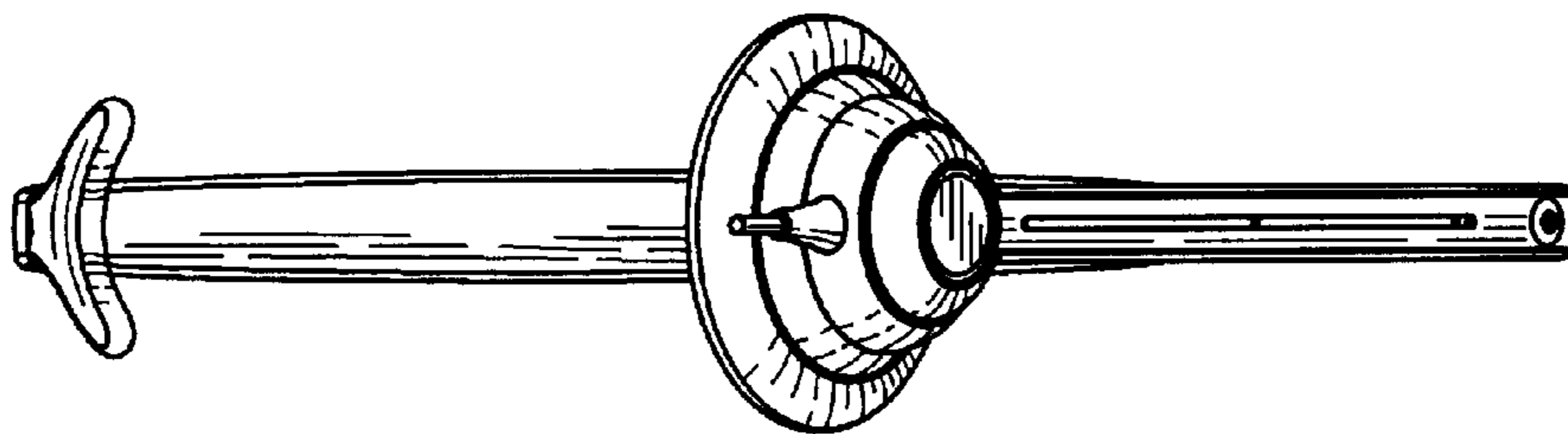

**FIG. 14**