



US00D514067S

(12) **United States Design Patent**  
**Lee**

(10) **Patent No.:** **US D514,067 S**  
(45) **Date of Patent:** **\*\* Jan. 31, 2006**

(54) **MULTIPLE OUTLET WALL TAP**

D468,848 S \* 1/2003 Schenck ..... D26/26  
D469,062 S \* 1/2003 Nieto et al. .... D13/137.2  
D495,657 S \* 9/2004 Lee ..... D13/137.2

(75) Inventor: **Dominic Kan Nam. Lee**, Kowloon  
(HK)

\* cited by examiner

(73) Assignee: **Multiway Industries, Ltd.**, Hong Kong  
(HK)

*Primary Examiner*—Pamela Burgess  
*Assistant Examiner*—Rosemary Tarca

(\*\*) Term: **14 Years**

(74) *Attorney, Agent, or Firm*—Frost Brown Todd LLC

(21) Appl. No.: **29/213,293**

(57) **CLAIM**

(22) Filed: **Sep. 15, 2004**

The ornamental design for a multiple outlet wall tap, as shown and described.

(51) **LOC (8) Cl.** ..... **13-03**

**DESCRIPTION**

(52) **U.S. Cl.** ..... **D13/137.2**

(58) **Field of Classification Search** ..... D13/123,

D13/133, 137.1–137.4, 139.1–139.8, 160;  
D26/26; 174/48–49, 53–57; 191/12 R, 12.4;  
361/42; 439/105–107, 535–536, 538, 650–655

See application file for complete search history.

FIG. 1 presents a pictorial view of my new multiple outlet wall tap design.

FIG. 2 presents a front elevational view of the multiple outlet wall tap illustrated in FIG. 1.

FIG. 3 presents a left side elevational view of the multiple outlet wall tap illustrated in FIG. 1.

FIG. 4 presents a rear elevational view of the multiple outlet wall tap illustrated in FIG. 1.

FIG. 5 presents a right side elevational view of the multiple outlet wall tap illustrated in FIG. 1.

FIG. 6 presents a top view of the multiple outlet wall tap illustrated in FIG. 1; and,

FIG. 7 presents a bottom view of the multiple outlet wall tap illustrated in FIG. 1.

The broken lines in the drawings are for illustrative purposes only and form no part of the claimed design.

(56) **References Cited**

**U.S. PATENT DOCUMENTS**

- 2,636,096 A \* 4/1953 Di Blasi ..... 337/189
- 4,543,624 A \* 9/1985 Rumble ..... 363/146
- D364,826 S \* 12/1995 Wu ..... D10/75
- D380,564 S \* 7/1997 Yuen ..... D26/26
- D401,555 S \* 11/1998 Tam ..... D13/137.3
- D440,203 S \* 4/2001 Ewing et al. .... D13/137.2
- D442,550 S \* 5/2001 Tong et al. .... D13/137.2
- D442,916 S \* 5/2001 Tong et al. .... D13/137.2
- D467,873 S \* 12/2002 Yu ..... D13/137.2

**1 Claim, 4 Drawing Sheets**

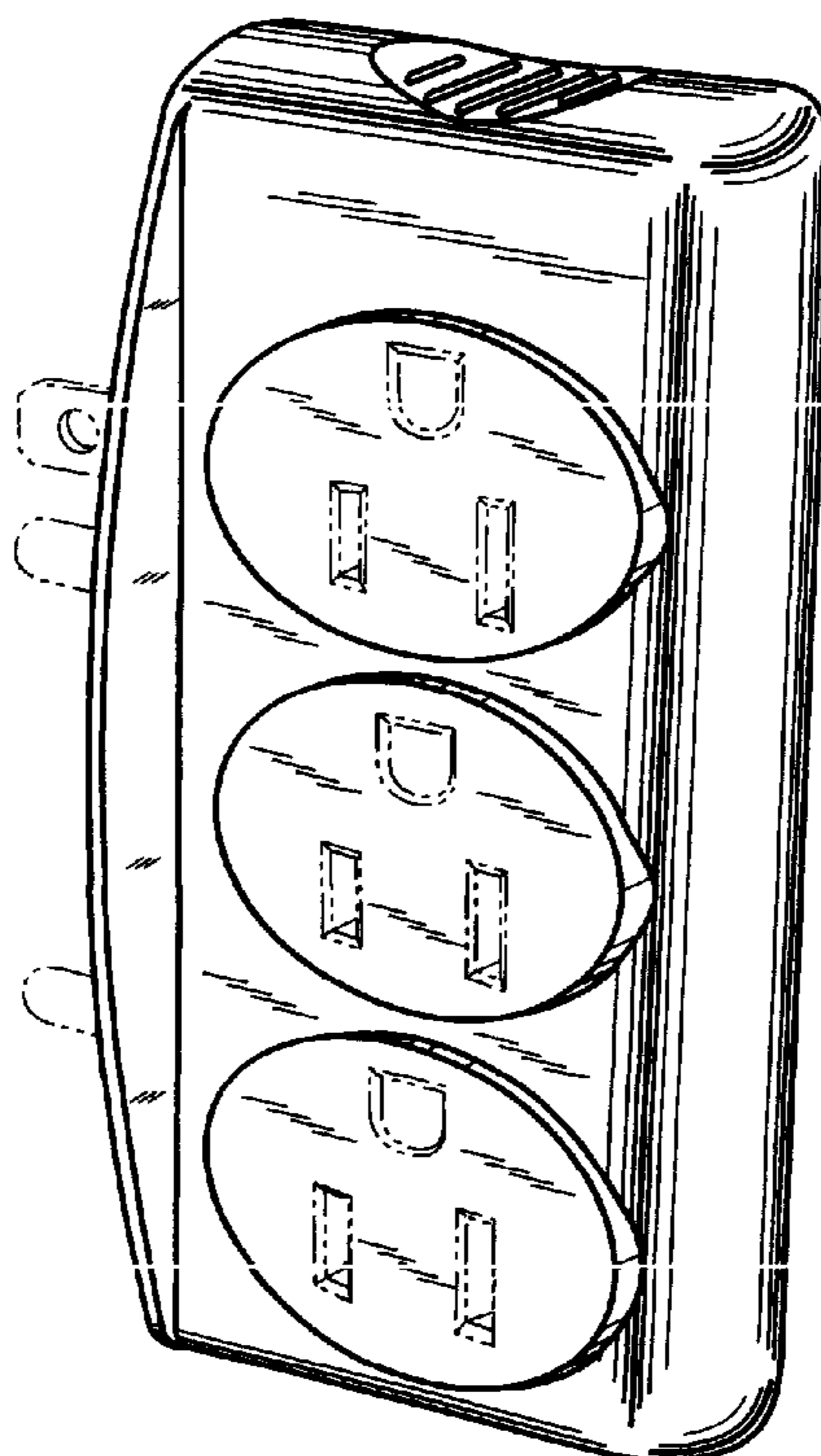

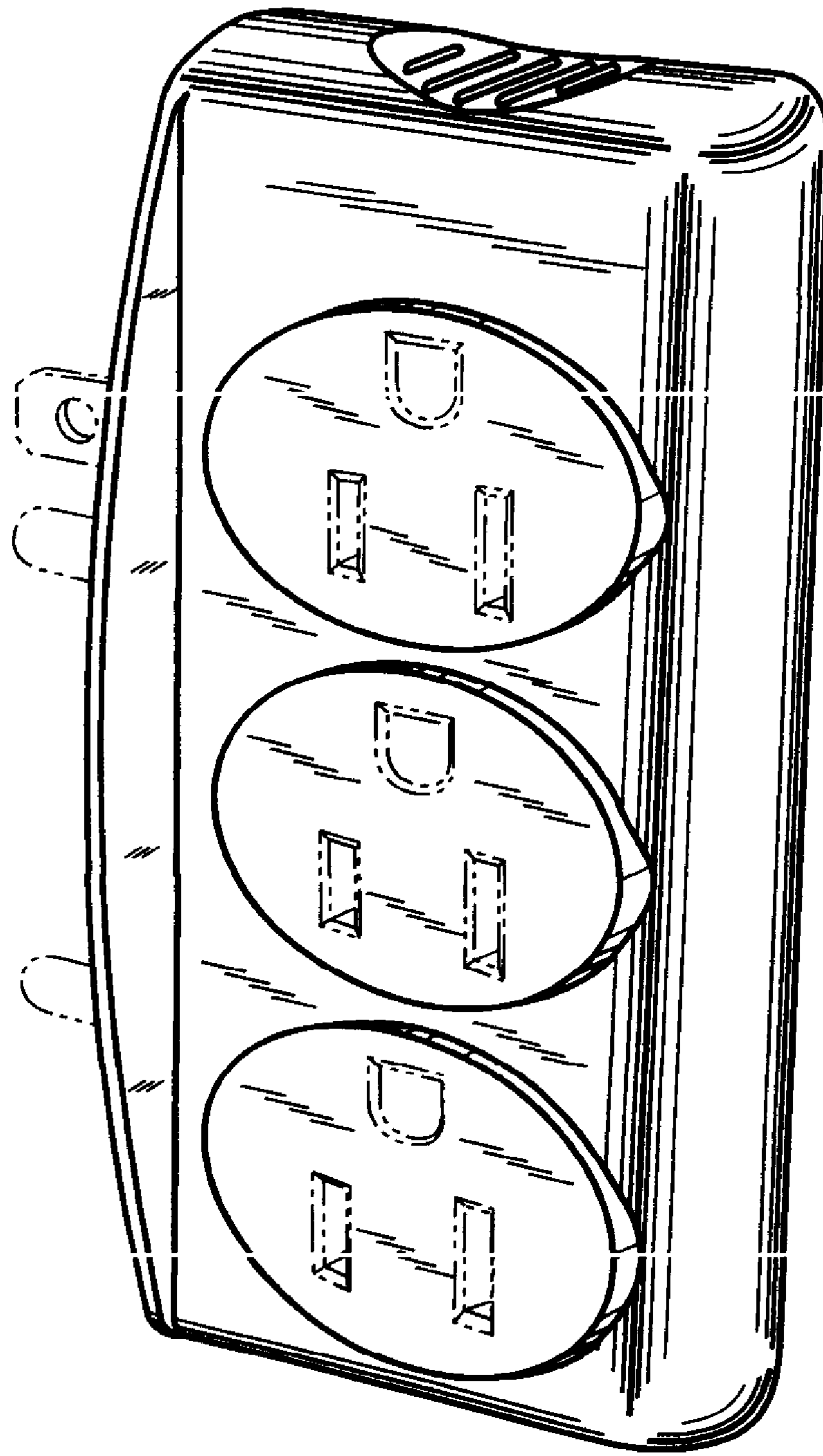

— FIG. 1

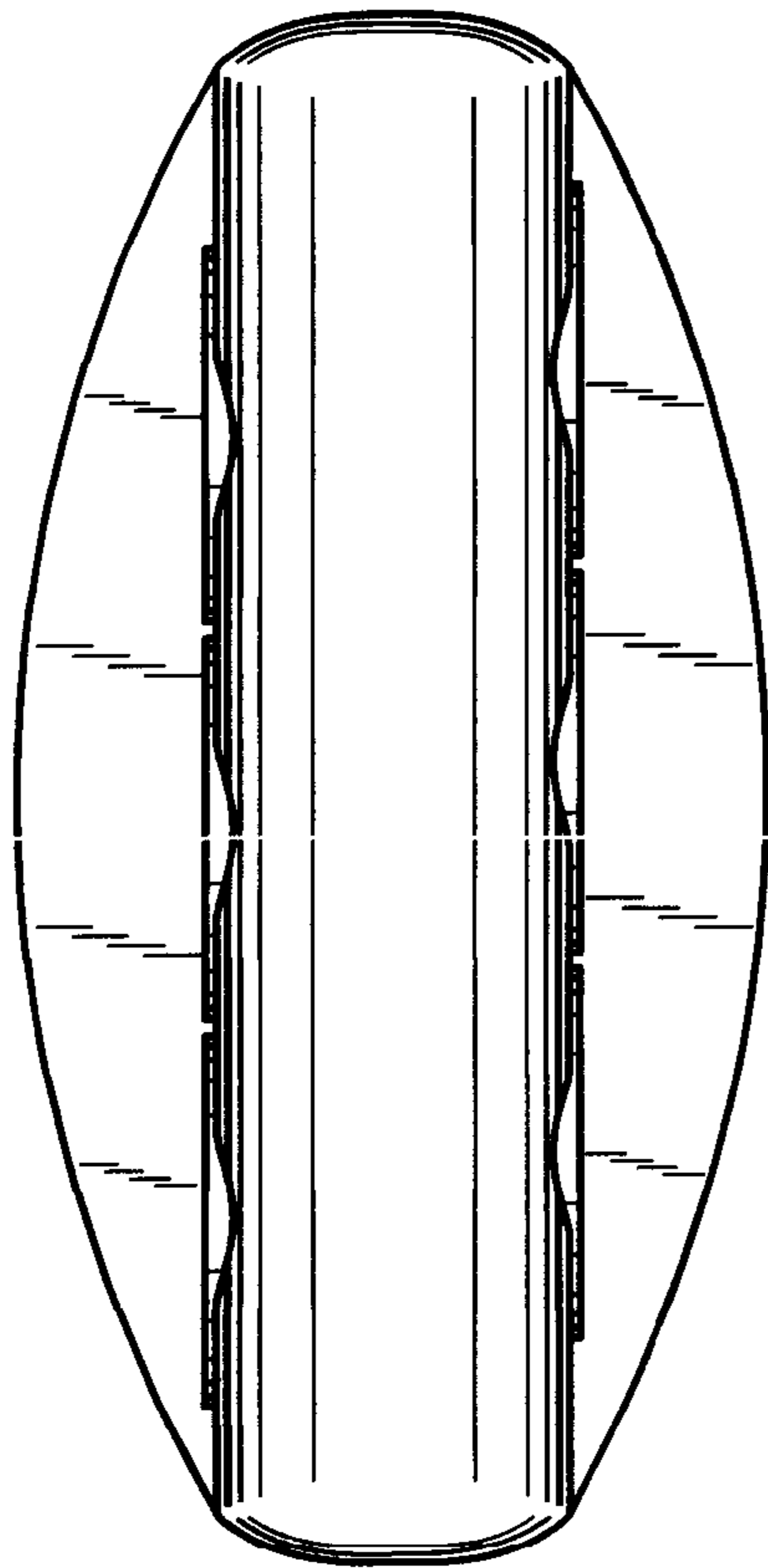

—FIG. 2

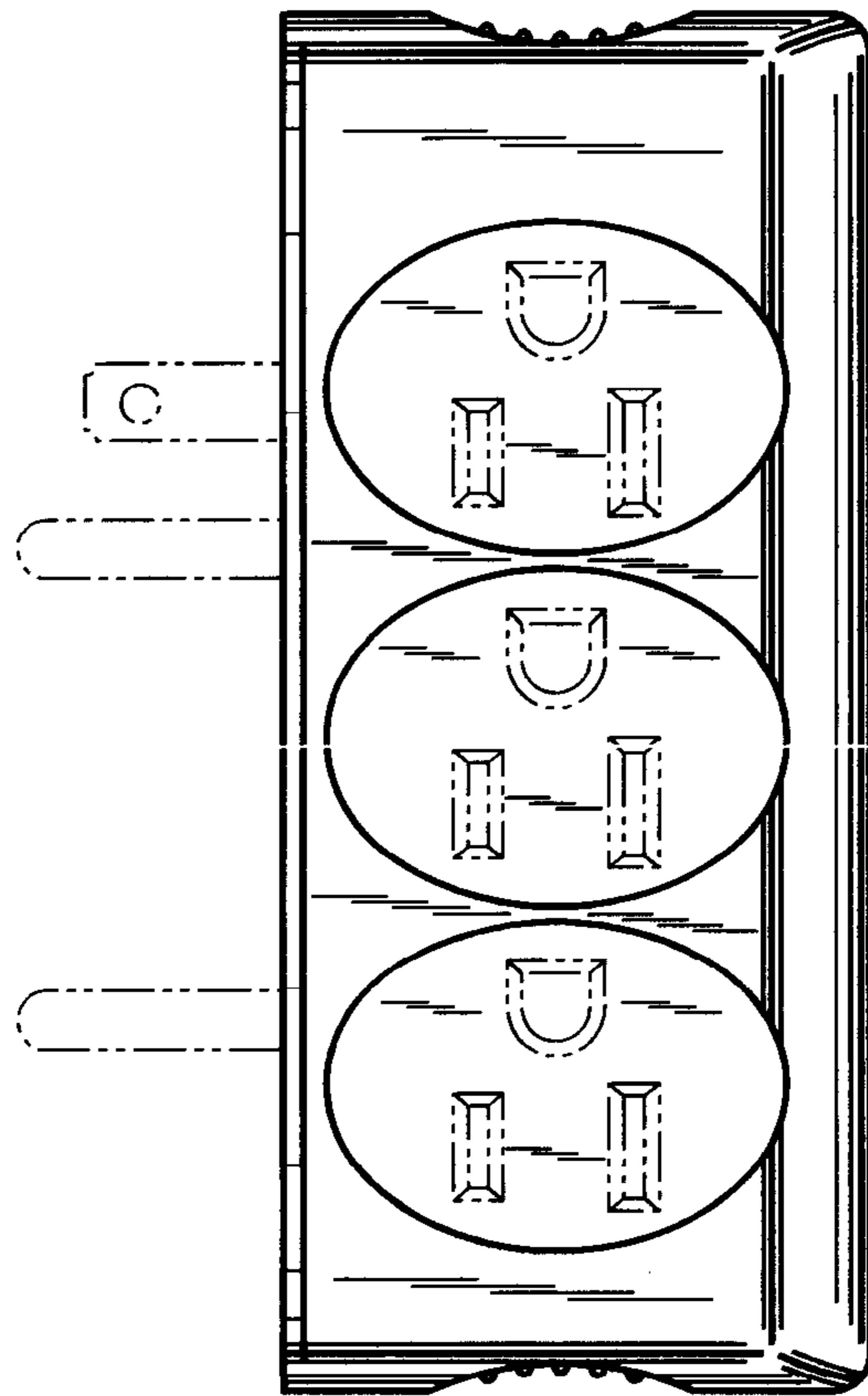

—FIG. 3

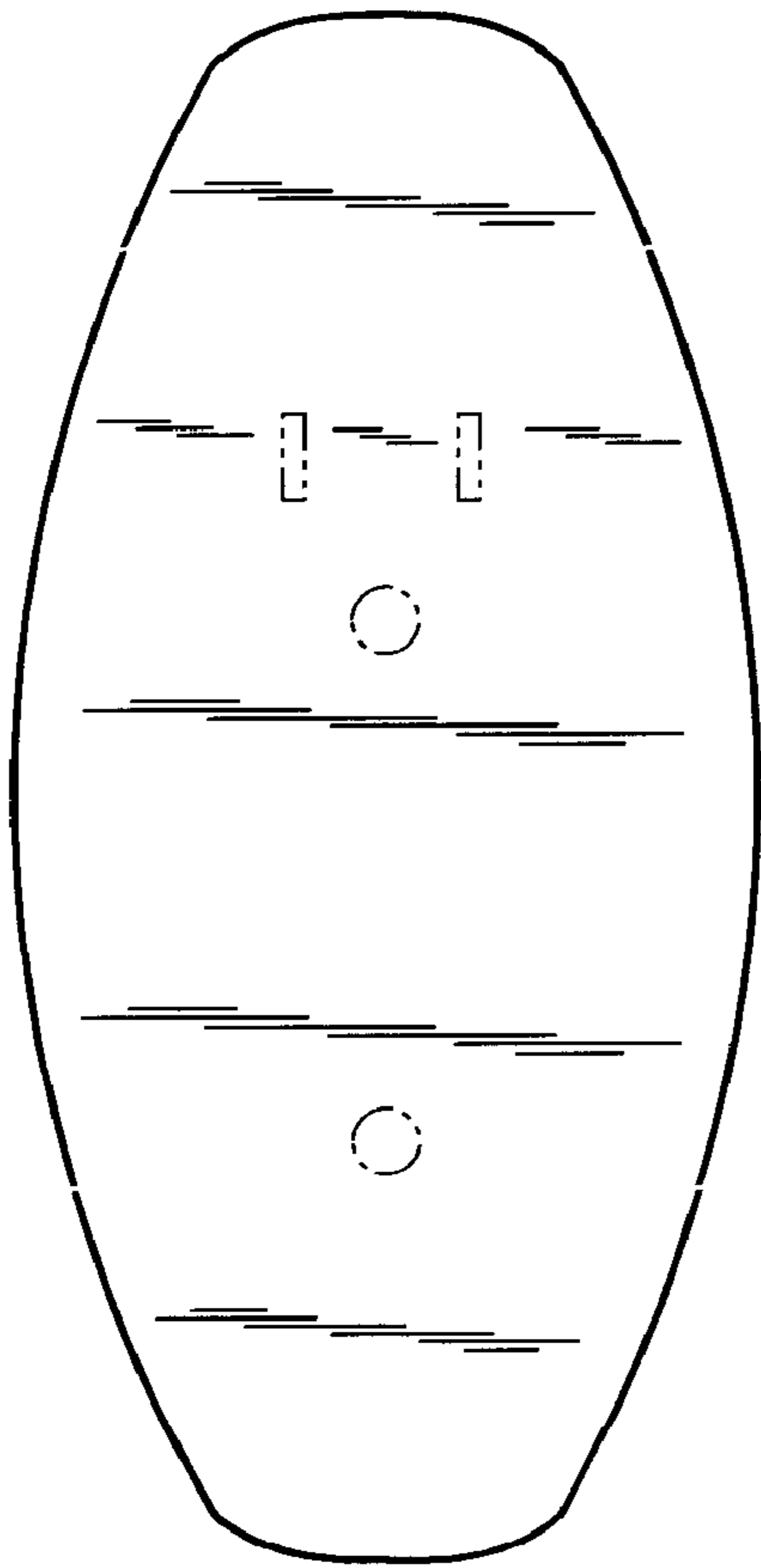

—FIG. 4

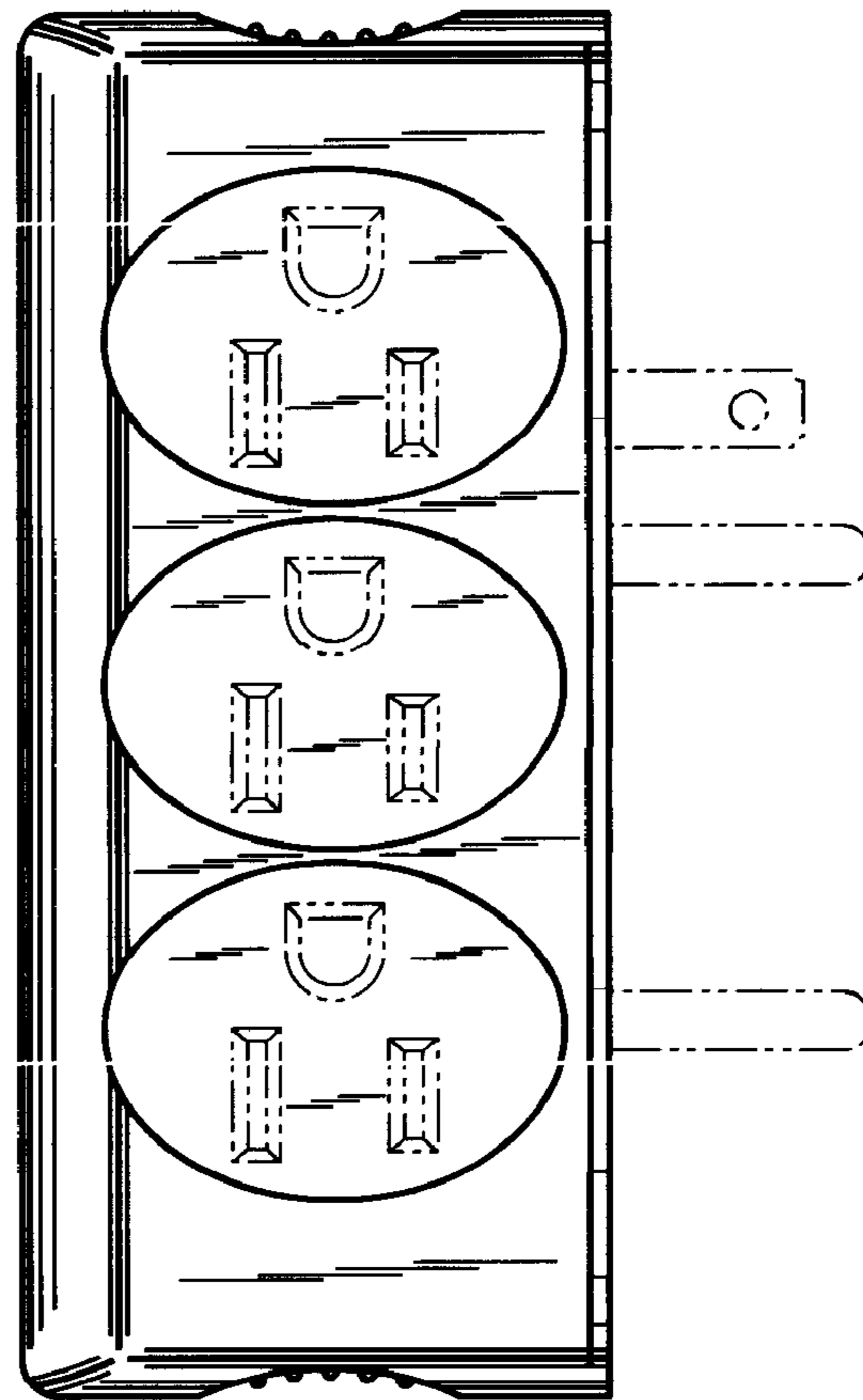

—FIG. 5

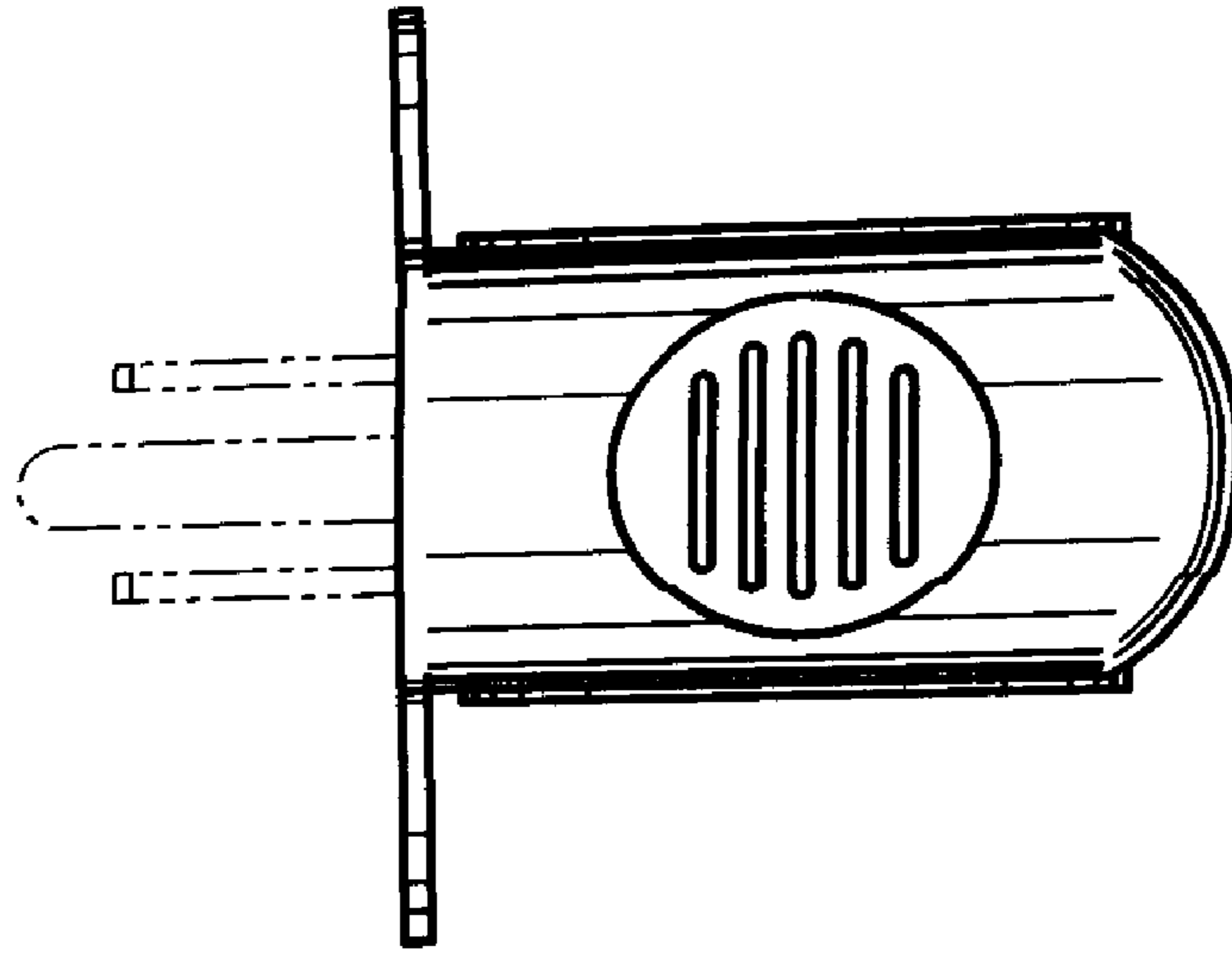

—FIG. 6

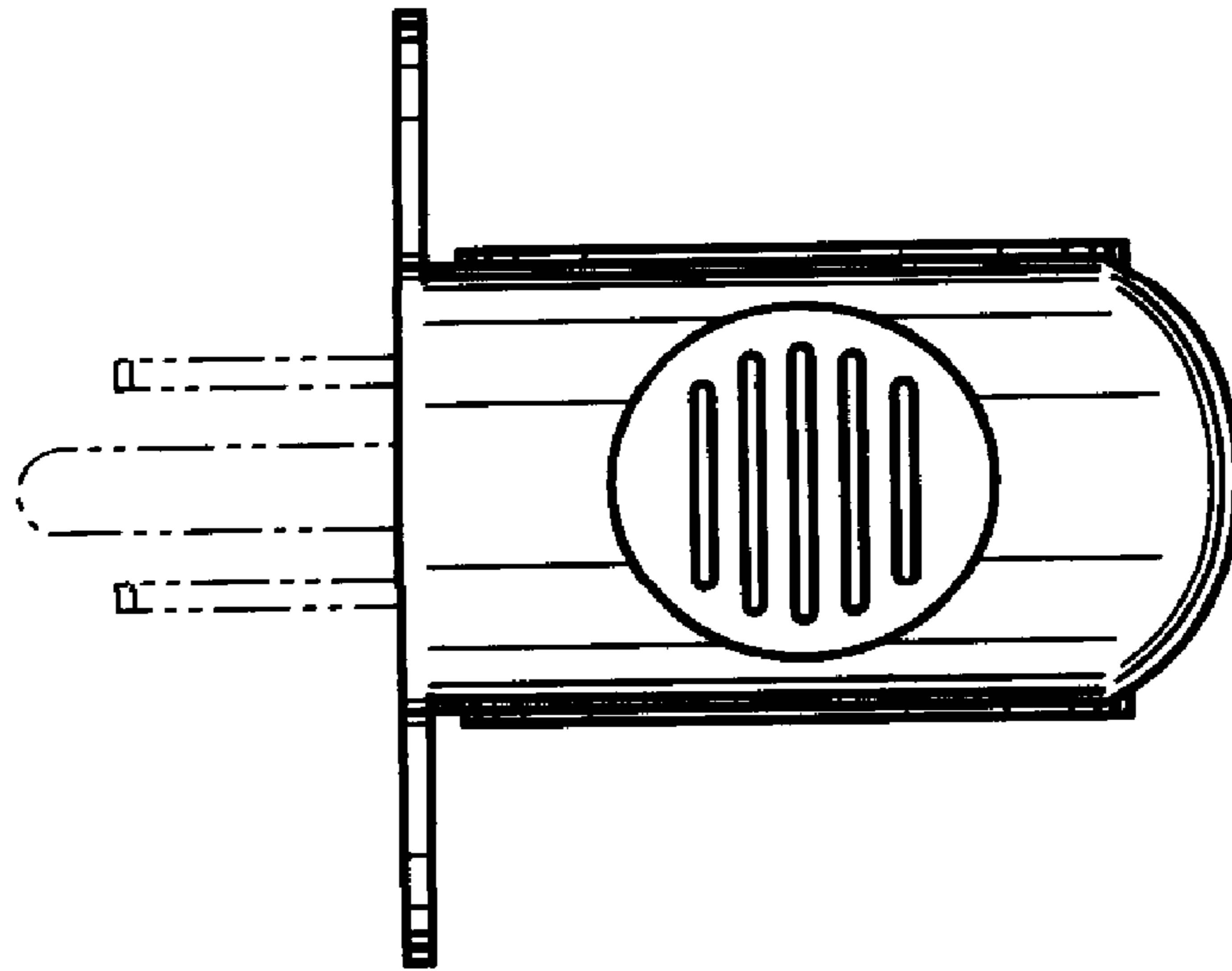

—FIG. 7