



US00D513953S

(12) **United States Design Patent** (10) **Patent No.:** **US D513,953 S**
Peterson (45) **Date of Patent:** **** Jan. 31, 2006**

(54) **HEAVY DUTY DRILL SHEAR ATTACHMENT**

(75) Inventor: **Eric L. Peterson**, Maple Lake, MN (US)

(73) Assignee: **Malco Products, Inc.**, Annandale, MN (US)

(**) Term: **14 Years**

(21) Appl. No.: **29/195,810**

(22) Filed: **Dec. 16, 2003**

Related U.S. Application Data

(63) Continuation-in-part of application No. 29/176,745, filed on Feb. 25, 2003, now Pat. No. Des. 488,695.

(51) **LOC (8) Cl.** **08-03**

(52) **U.S. Cl.** **D8/70**

(58) **Field of Classification Search** D8/61, D8/62, 63, 64, 65, 66, 67, 68, 69, 70, 71; D15/132, 138, 139, 140; 30/228, 247, 500
See application file for complete search history.

(56) **References Cited**

U.S. PATENT DOCUMENTS

2,047,483 A	7/1936	McArdle et al.	
2,256,779 A	9/1941	McHenry	
2,604,695 A	7/1952	McGary et al.	
2,635,335 A	4/1953	James	
2,760,265 A	8/1956	Draenert	
D197,987 S	* 4/1964	Docken	D8/70
D222,332 S	* 10/1971	Current	D8/61
3,654,700 A	4/1972	Pawloski	
D229,023 S	* 11/1973	Laurenti	D8/61
3,787,742 A	1/1974	Murphy	
3,808,682 A	5/1974	Sumida	
4,369,576 A	1/1983	McVaugh	
4,682,416 A	7/1987	Stolfa	

5,901,447 A	5/1999	Dunning	
5,992,024 A	11/1999	Rogers	
5,993,303 A	* 11/1999	Fladgard et al.	30/228
D426,443 S	6/2000	Lai	
6,178,643 B1	1/2001	Erbrick et al.	
D443,806 S	6/2001	Fladgard et al.	
6,250,998 B1	6/2001	Fladgard et al.	
D488,695 S	4/2004	Peterson	
6,776,150 B2	* 8/2004	Gaidjergis et al.	30/228
2005/0028391 A1	* 2/2005	Peterson	30/500

OTHER PUBLICATIONS

Excalibur Tools Ply Limited brochure: Jan. 24, 2003; Internet portion.

* cited by examiner

Primary Examiner—Gary D. Watson

Assistant Examiner—T. Chase Nelson

(74) *Attorney, Agent, or Firm*—Gerald E. Helget; Nelson R. Capes; Briggs and Morgan, P.A.

(57) **CLAIM**

The ornamental design for a heavy duty drill shear attachment, as shown and described.

DESCRIPTION

FIG. 1 is a perspective view showing my new design heavy duty drill shear attachment;
FIG. 2 is a top plan view;
FIG. 3 is a right side elevational view;
FIG. 4 is a front elevational view;
FIG. 5 is a rear elevational view;
FIG. 6 is a left side elevational view; and,
FIG. 7 is a bottom plan view.

The broken line drawings of FIG. 1 are for illustrative purposes only to show environment and form no part of the claimed design.

1 Claim, 3 Drawing Sheets

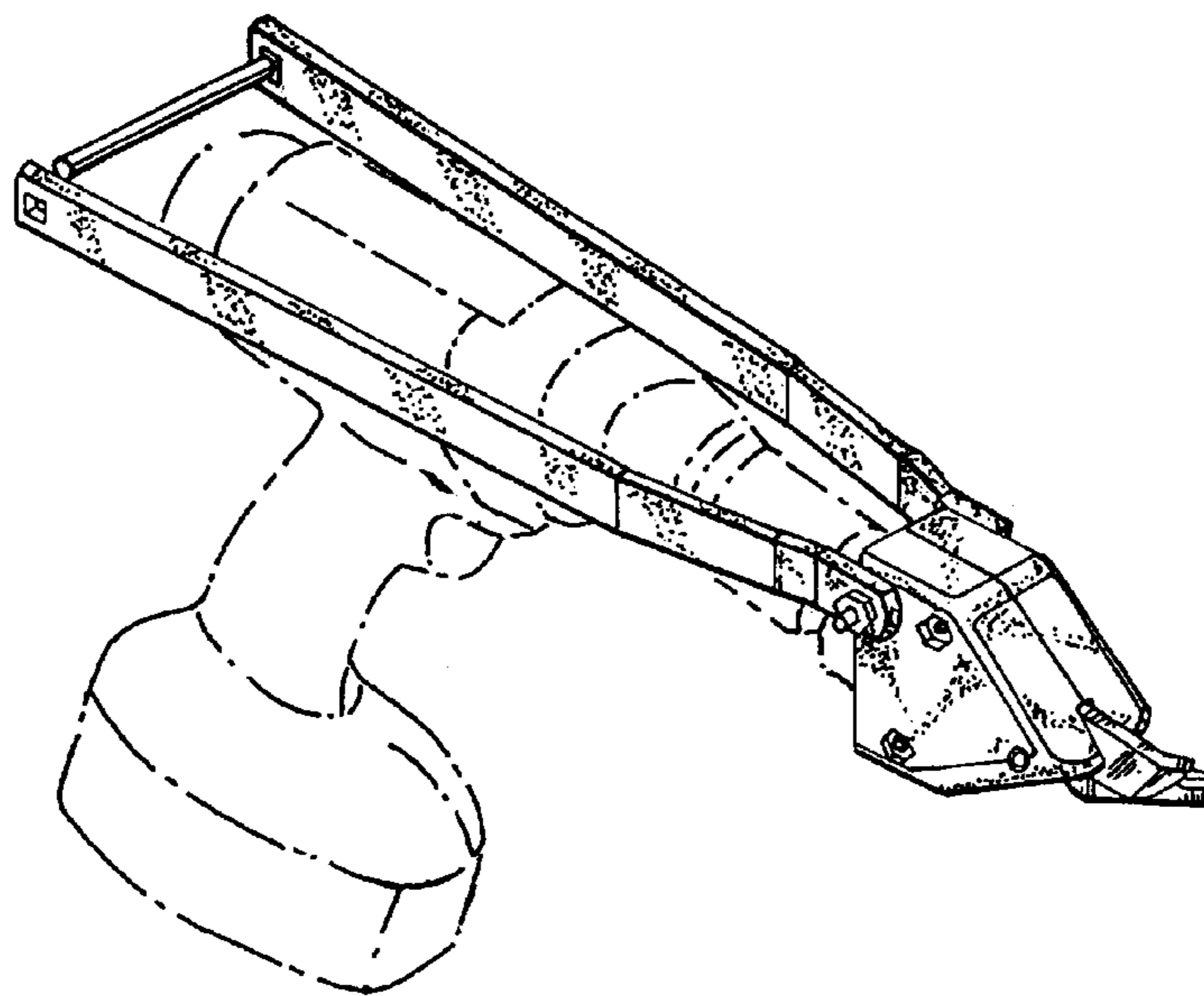

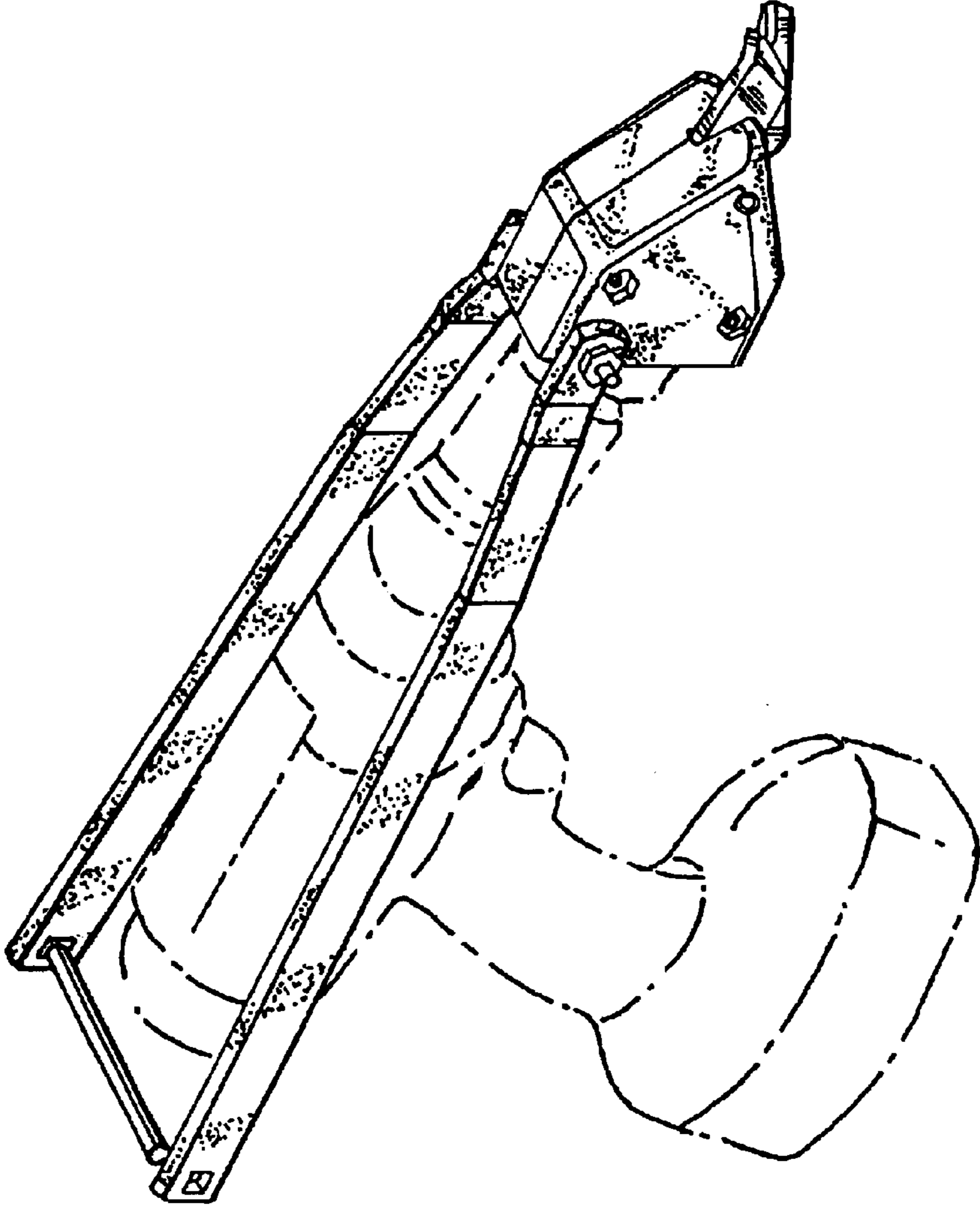

Fig. 1.

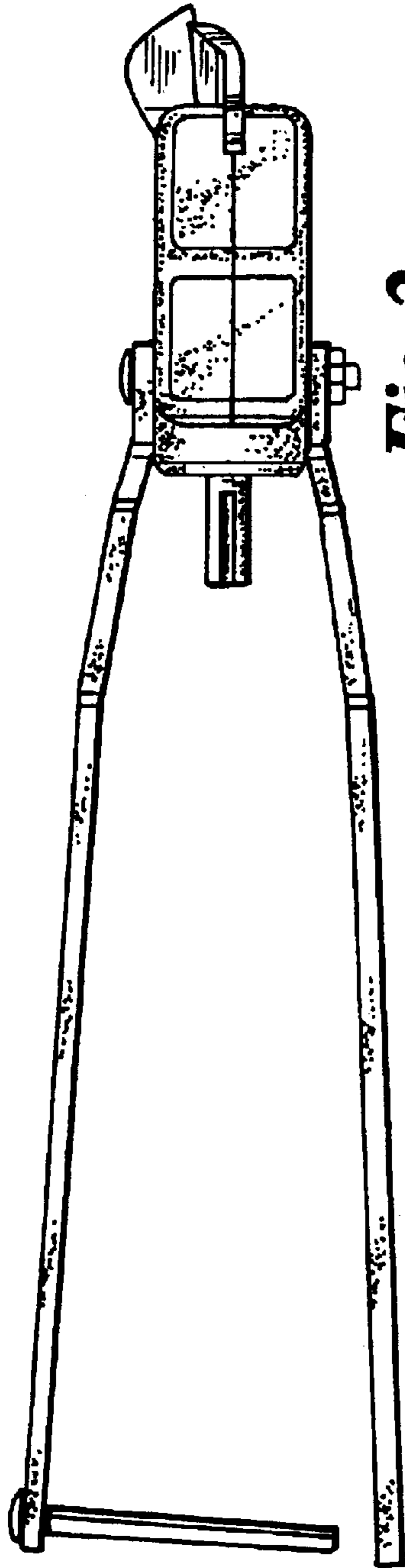

Fig. 2.

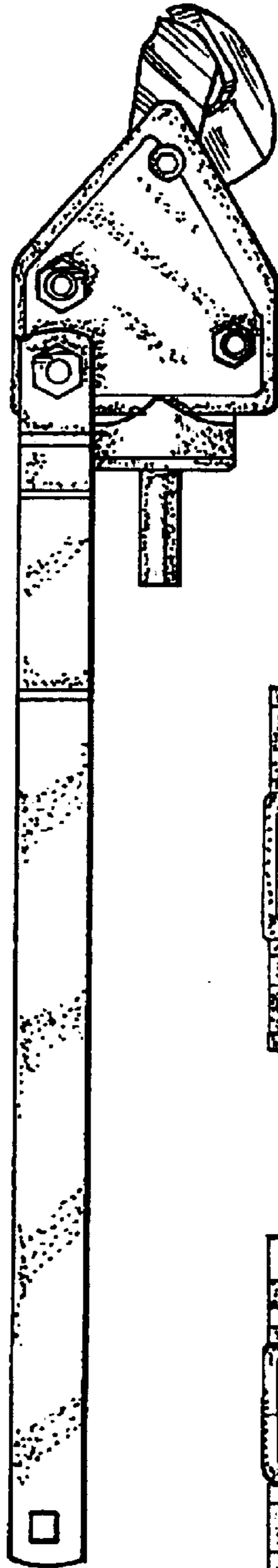

Fig. 3.

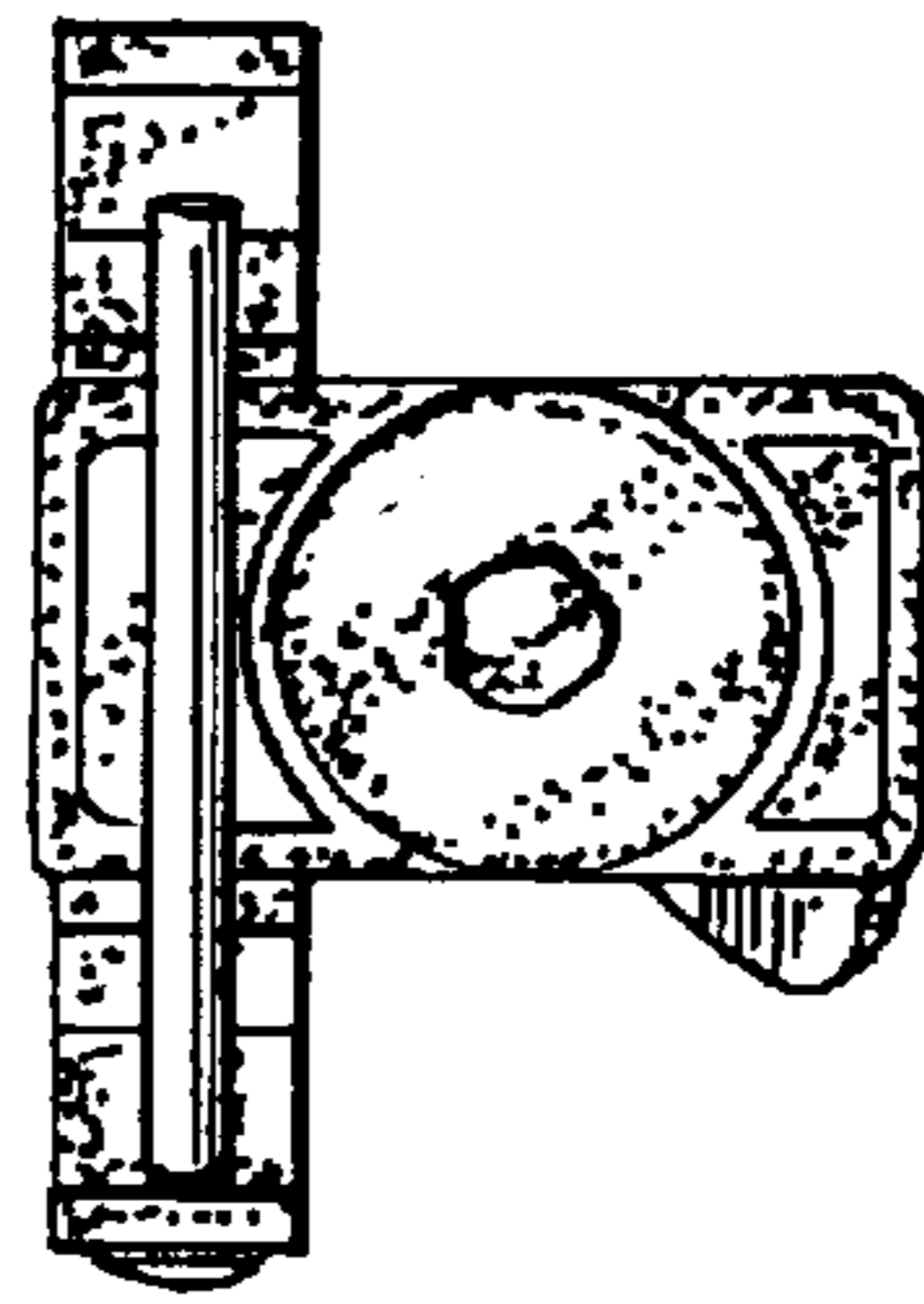

Fig. 5.

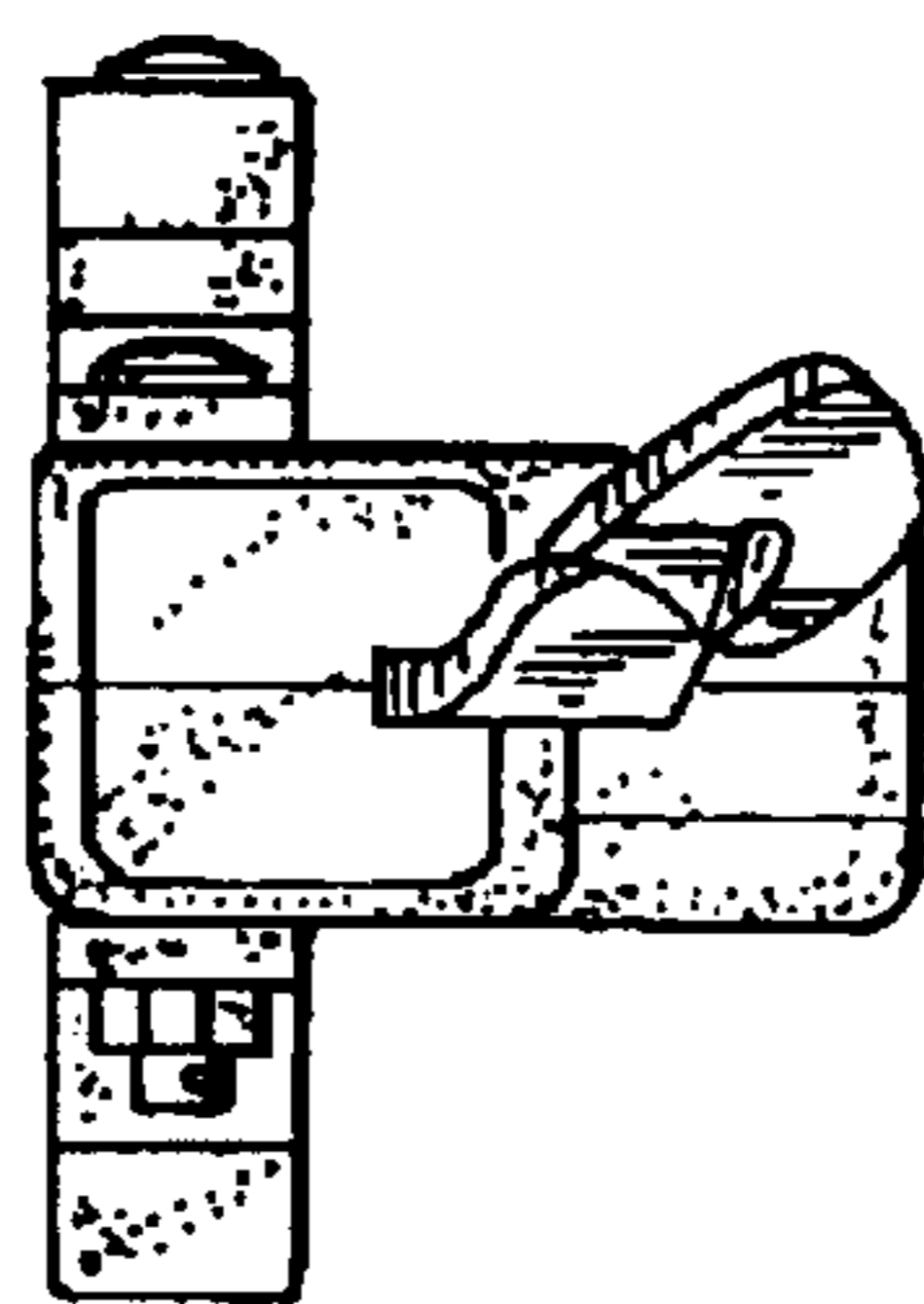

Fig. 4.

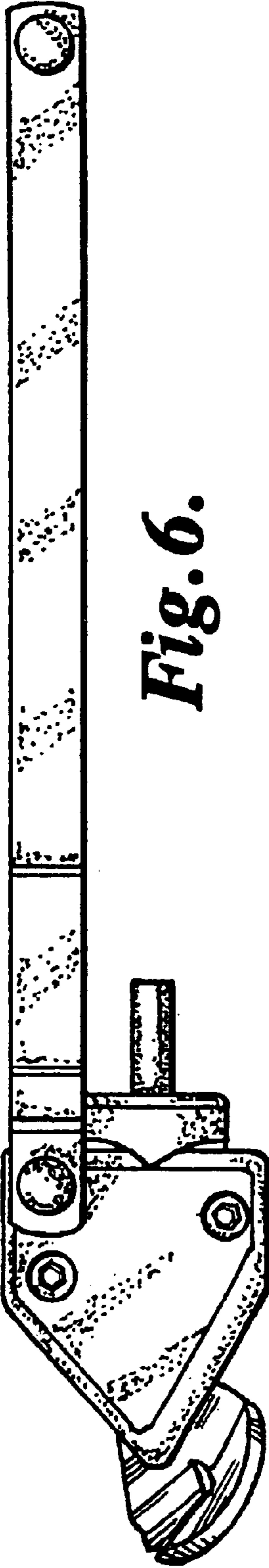

Fig. 6.

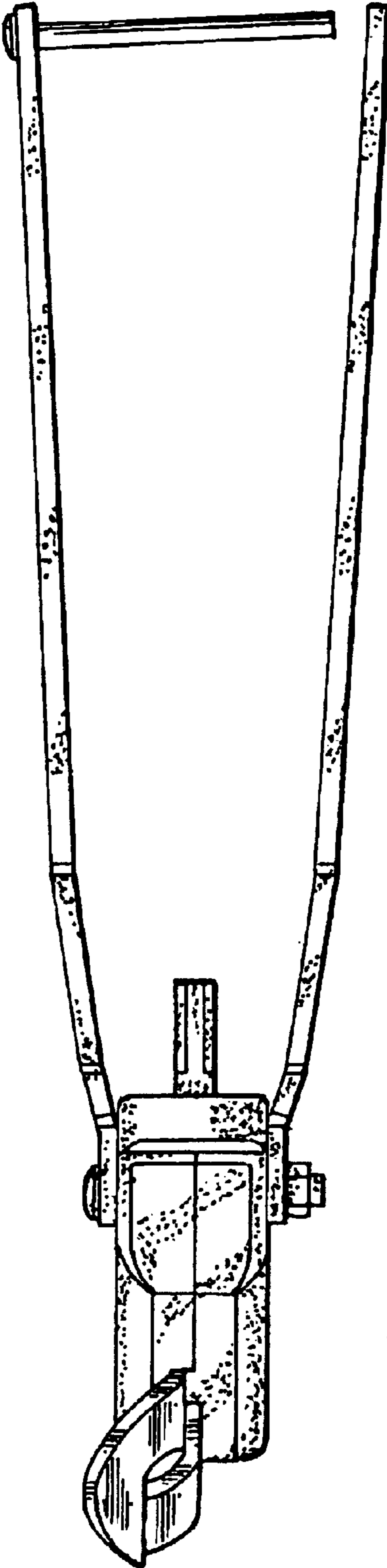

Fig. 7.