



US00D513950S

(12) **United States Design Patent**
So

(10) **Patent No.:** **US D513,950 S**

(45) **Date of Patent:** **** Jan. 31, 2006**

(54) **CAN OPENER**

(76) **Inventor:** **Shun So**, 2nd Floor, Chuan Yuan
Factory Building, 342-344 Kwun Tong
Road, Kwun Tong, Kowloon (HK)

(**) **Term:** **14 Years**

(21) **Appl. No.:** **29/204,157**

(22) **Filed:** **Apr. 26, 2004**

(51) **LOC (8) Cl.** **07-99**

(52) **U.S. Cl.** **D8/40**

(58) **Field of Classification Search** D8/16-20,
D8/33-35, 38-43, 88, 89, 105; 7/138, 151-166;
30/1.5, 169, 400-450; 81/3.05-3.49; 294/15
See application file for complete search history.

(56) **References Cited**

U.S. PATENT DOCUMENTS

D294,449 S * 3/1988 Kuhn D8/34
D301,539 S * 6/1989 Cheung D8/41

D460,330 S * 7/2002 Huang D8/43
D488,976 S * 4/2004 Chen D8/41
D496,569 S * 9/2004 Shun D8/40

* cited by examiner

Primary Examiner—Caron D. Veynar

(74) *Attorney, Agent, or Firm*—Leydig, Voit & Mayer, Ltd.

(57) **CLAIM**

The ornamental design for a can opener, as shown and described.

DESCRIPTION

FIG. 1 is a top plan view of a can opener showing my new design;

FIG. 2 is a bottom plan view thereof;

FIG. 3 is a right side elevational view thereof;

FIG. 4 is a left side elevational view thereof;

FIG. 5 is a front end view thereof; and,

FIG. 6 is a rear end view thereof.

1 Claim, 6 Drawing Sheets

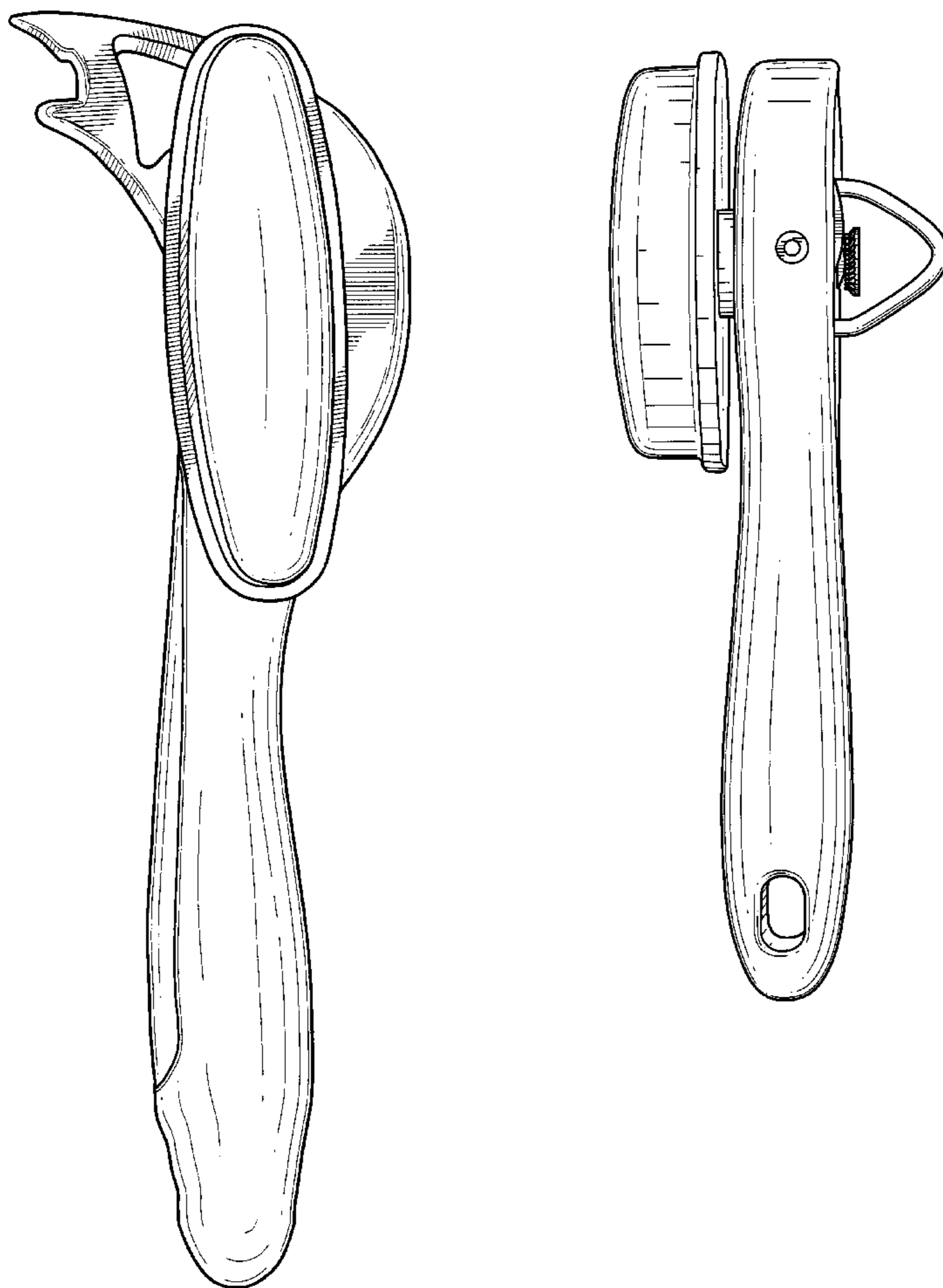

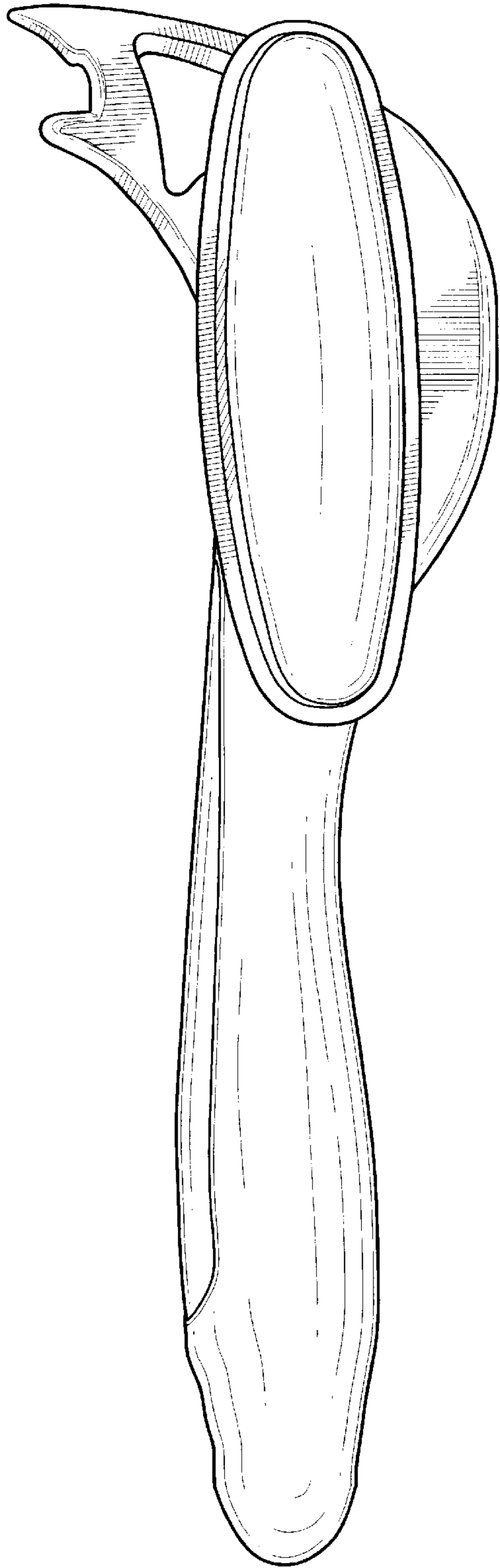

FIG. 1

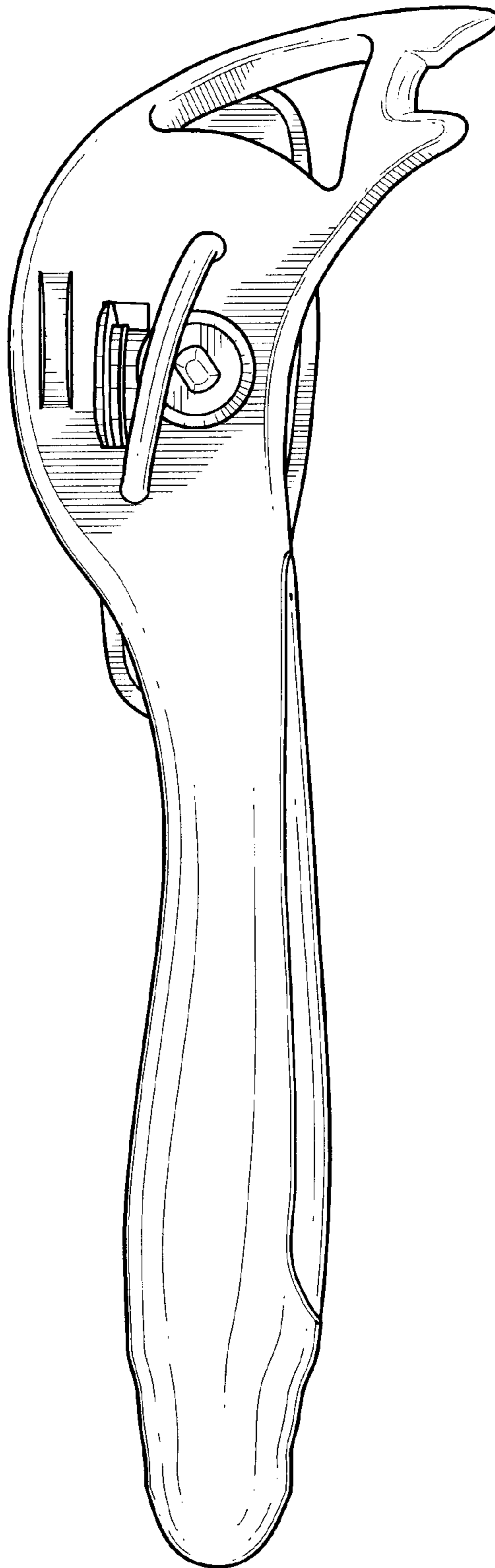

FIG. 2

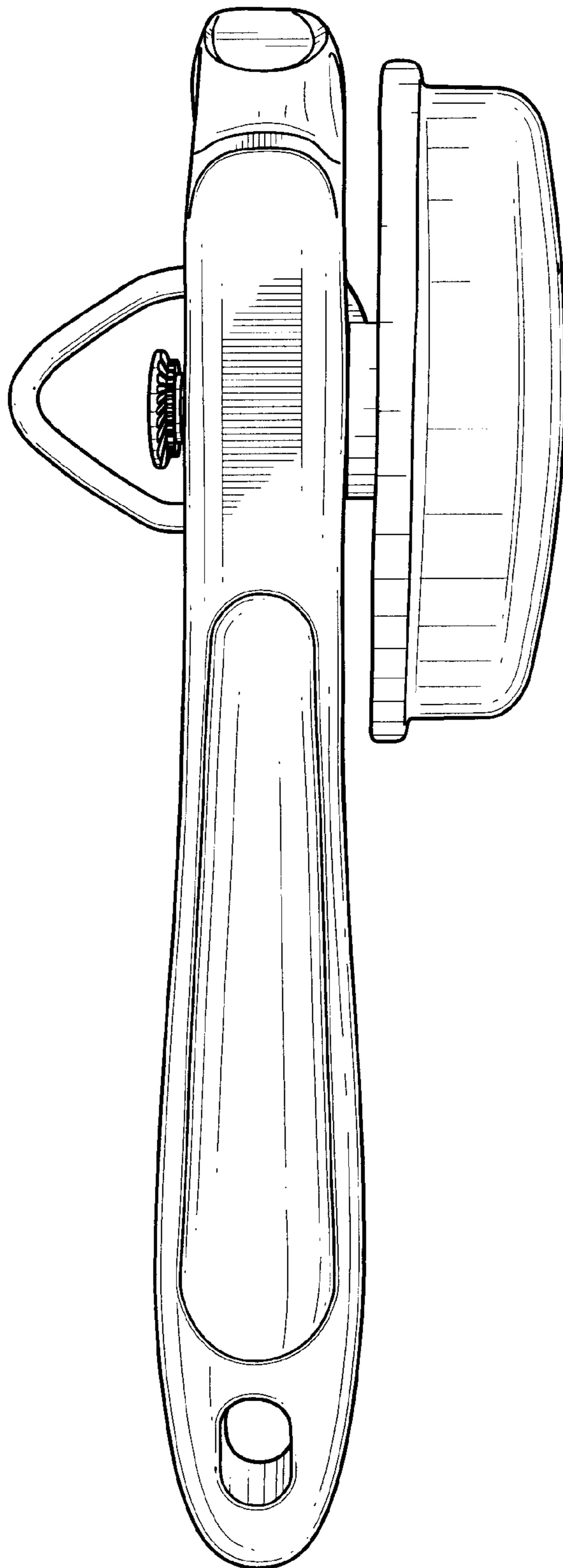

FIG. 3

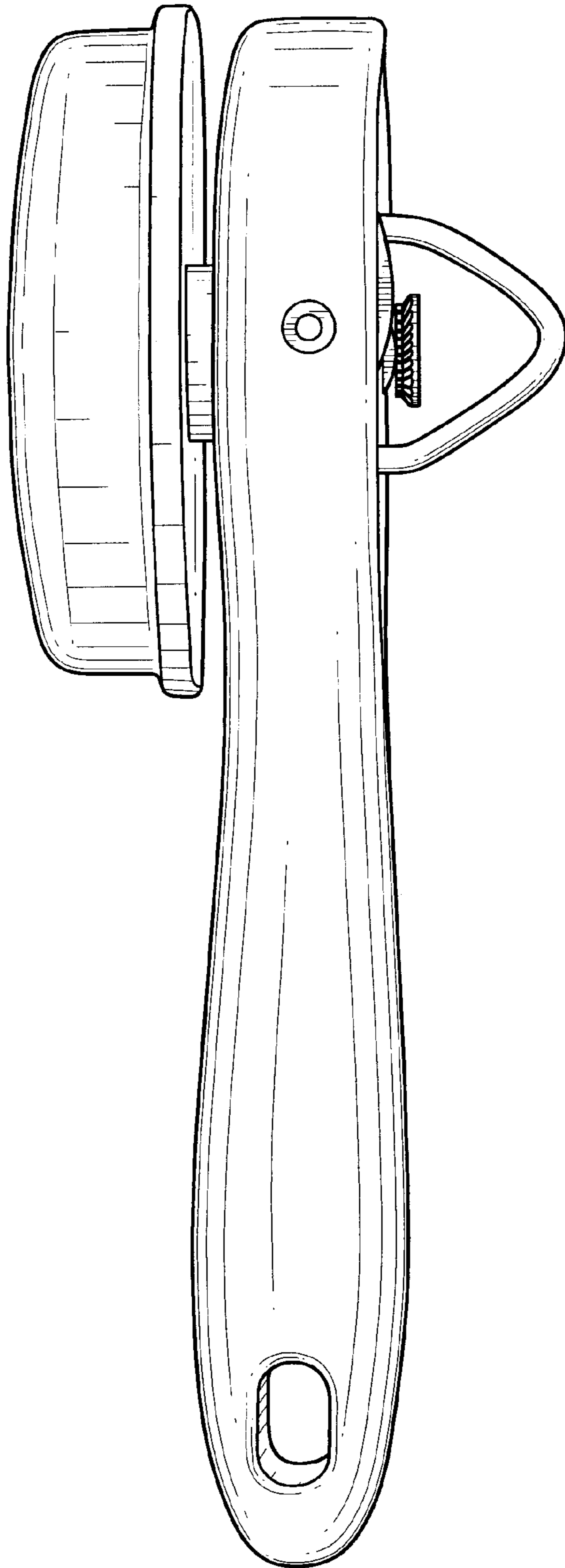

FIG. 4

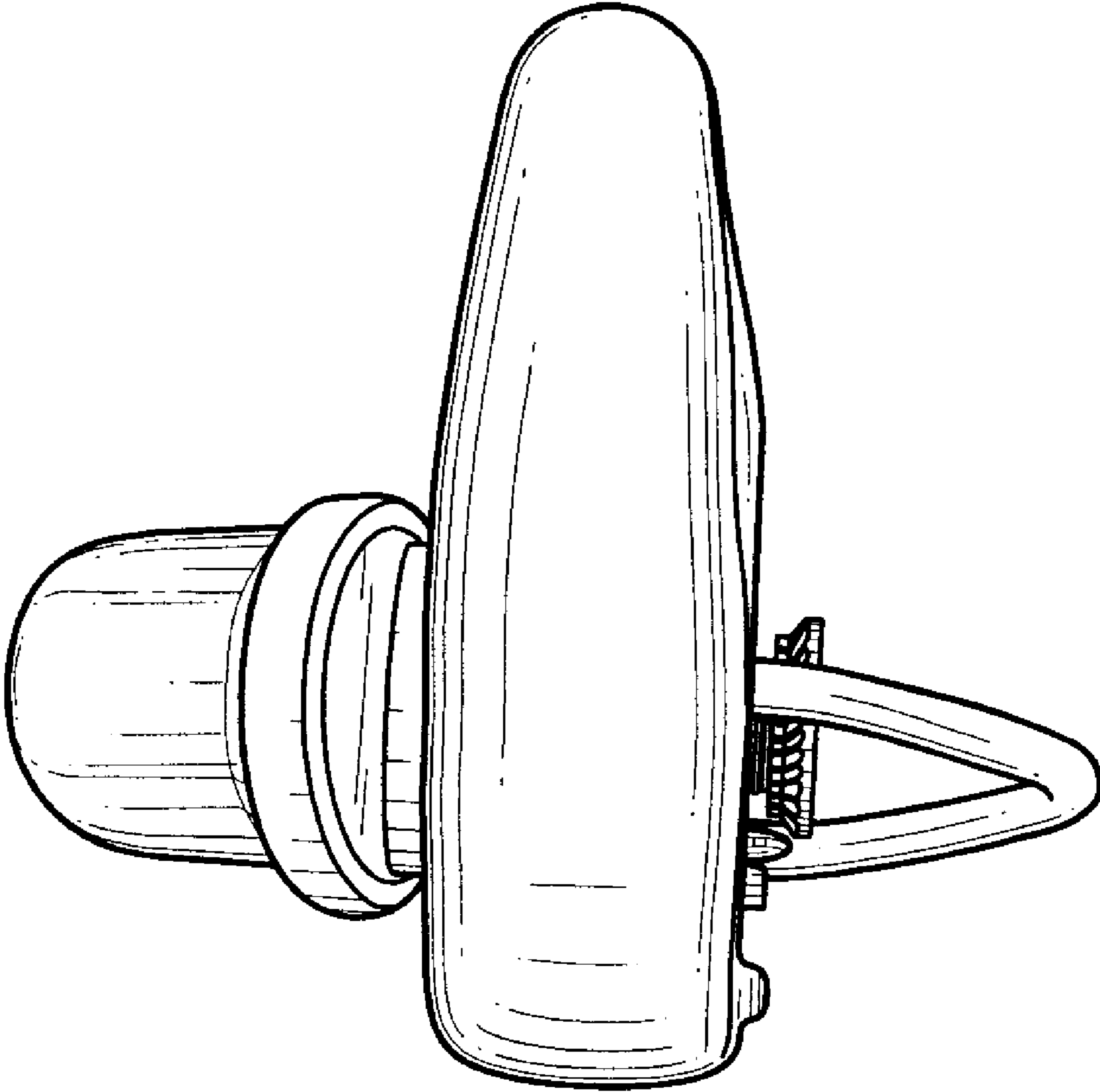

FIG. 5

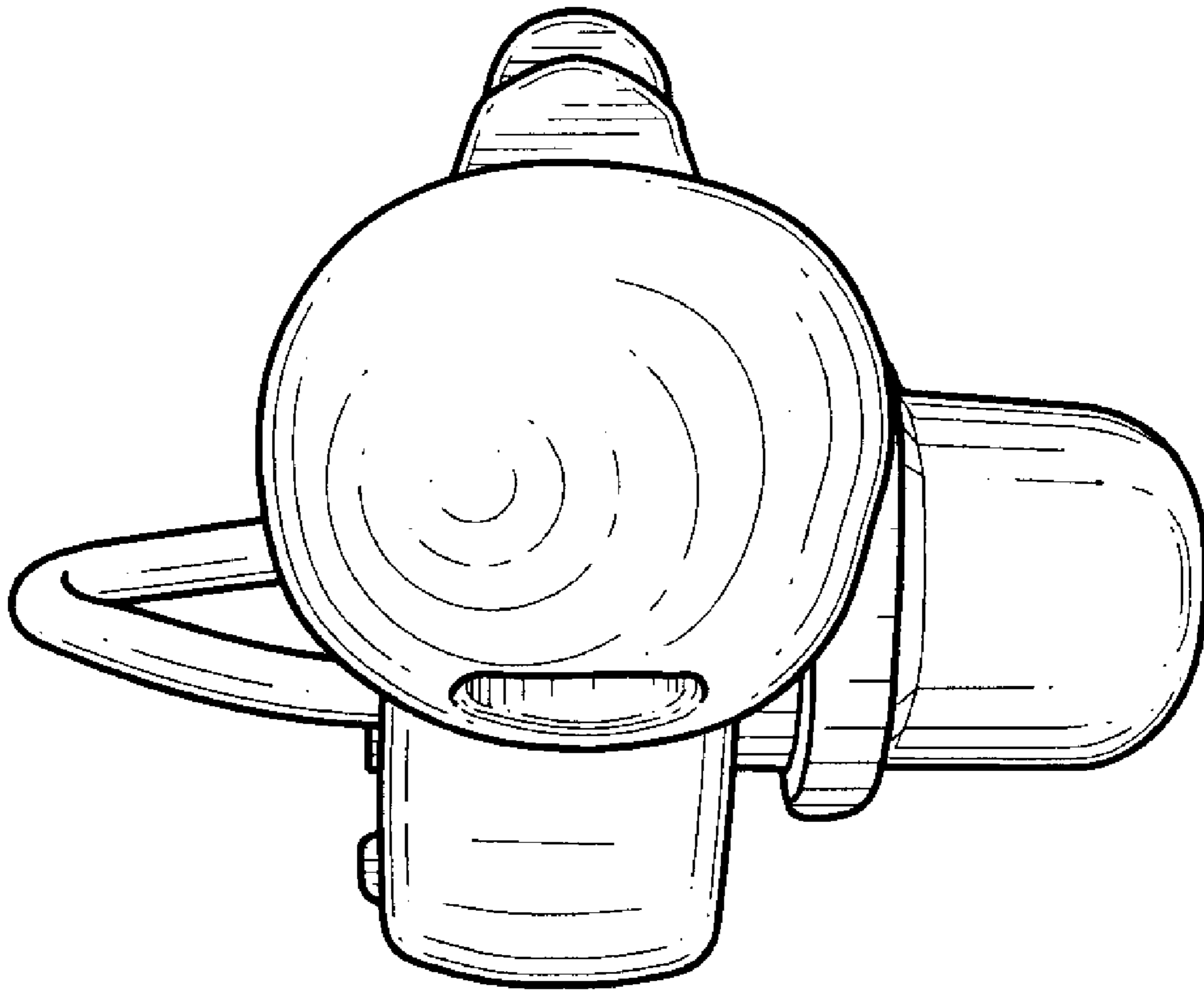

FIG. 6