

US00D513717S

(12) **United States Design Patent**
Wittkowski

(10) **Patent No.:** **US D513,717 S**
(45) **Date of Patent:** **** Jan. 24, 2006**

(54) **TANDEM AXLE TRAILER**

6,378,893 B1 * 4/2002 Jager 280/656
D469,388 S * 1/2003 Mighell D12/101
D471,845 S * 3/2003 Mighell D12/101

(75) Inventor: **Donald Richard Wittkowski**, Sullivan,
IL (US)

* cited by examiner

(73) Assignee: **Agri-Fab Incorporated**, Sullivan, IL
(US)

Primary Examiner—Melody N. Brown
(74) *Attorney, Agent, or Firm*—Vedder Price Kaufman &
Kammholz

(**) Term: **14 Years**

(57) **CLAIM**

(21) Appl. No.: **29/205,525**

The ornamental design for a tandem axle trailer, as shown
and described.

(22) Filed: **May 17, 2004**

(51) **LOC (8) Cl.** **12-10**

(52) **U.S. Cl.** **D12/101**

(58) **Field of Classification Search** D12/101,
D12/102; 280/475, 656, 763.1, 482, 462;
296/181, 190

See application file for complete search history.

DESCRIPTION

FIG. 1 is a perspective view of the tandem axle trailer
showing my new design;
FIG. 2 is a front view of my design;
FIG. 3 is a back view of my design;
FIG. 4 is a view of one side of my design;
FIG. 5 is a view of the other side of my design;
FIG. 6 is a top view of my design; and,
FIG. 7 is a bottom view of my design.

The wheels shown in broken lines are for illustrative pur-
poses only and form no part of the claimed design.

(56) **References Cited**

U.S. PATENT DOCUMENTS

D376,564 S * 12/1996 Mishoe D12/101
D414,720 S * 10/1999 Everett D12/101
D418,451 S * 1/2000 Konecheck D12/101

1 Claim, 4 Drawing Sheets

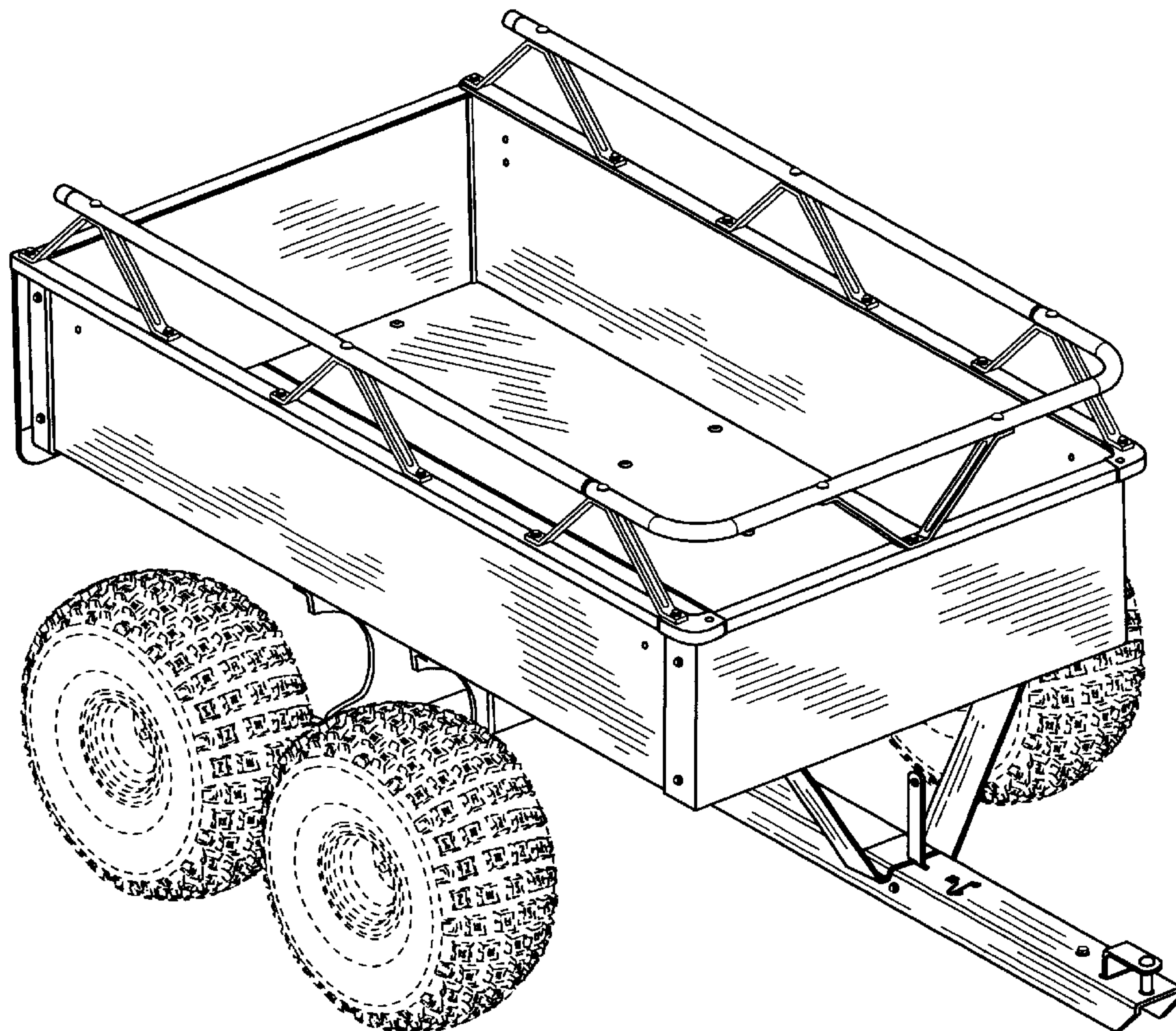

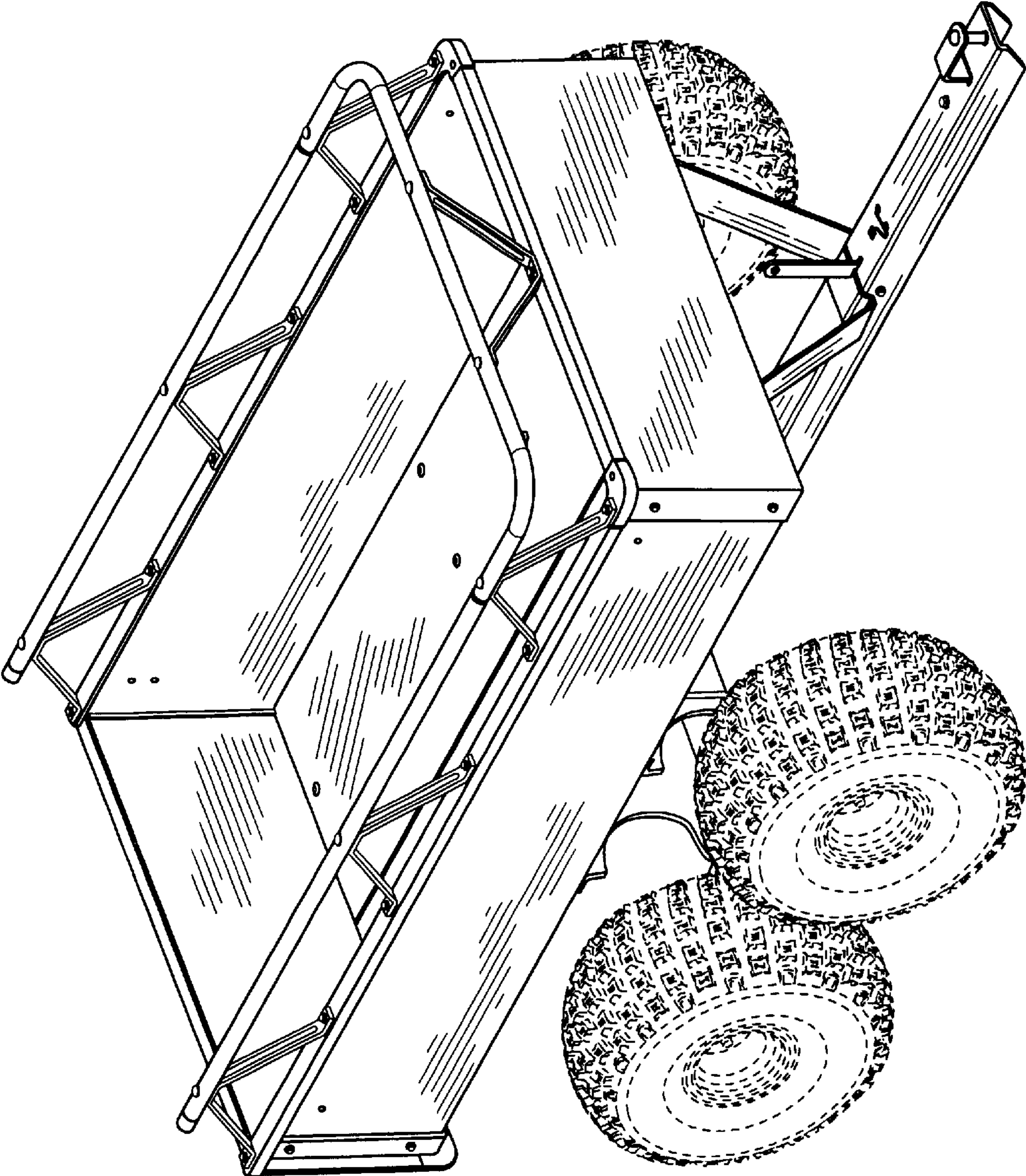

FIG. 1

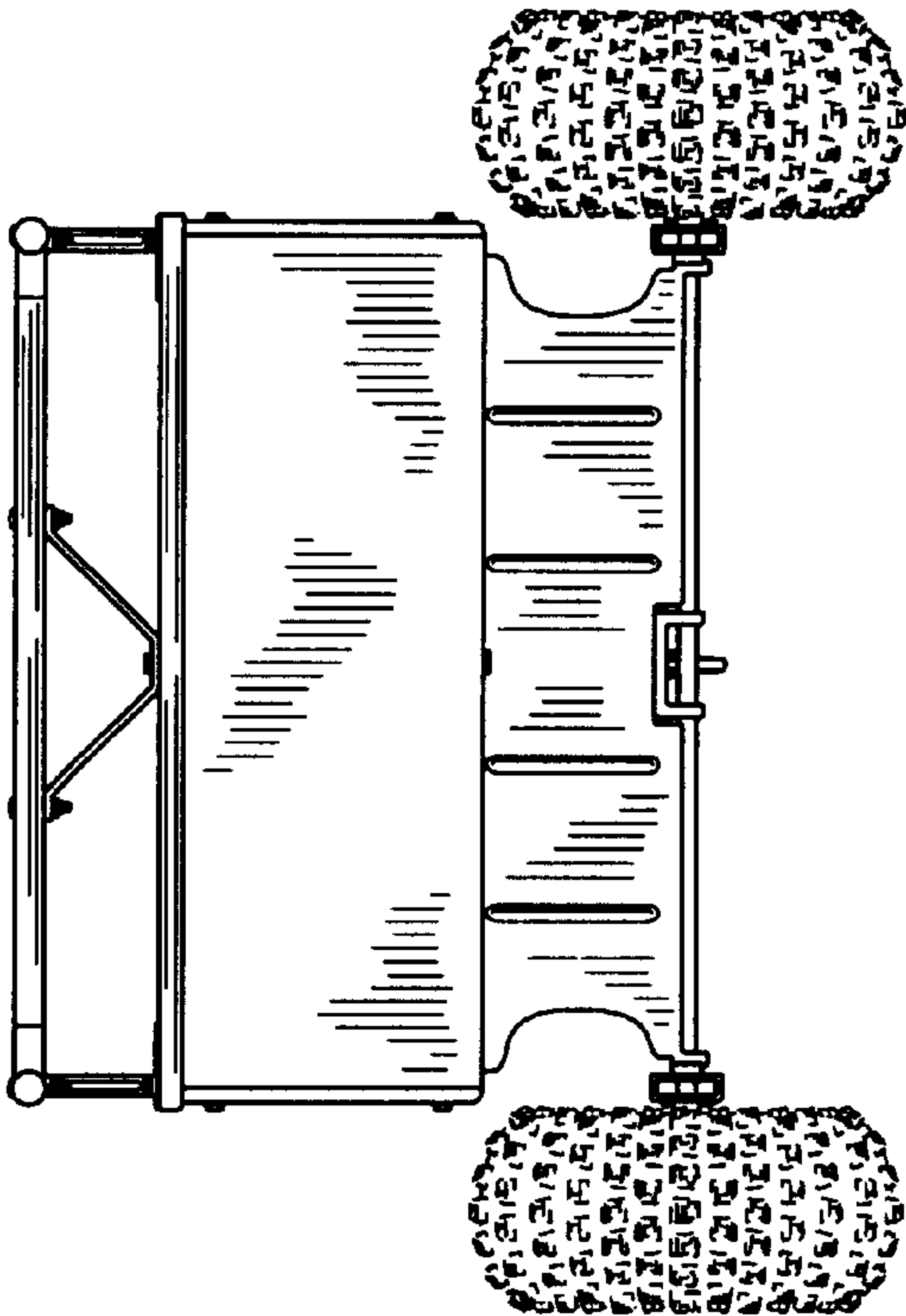

FIG. 2

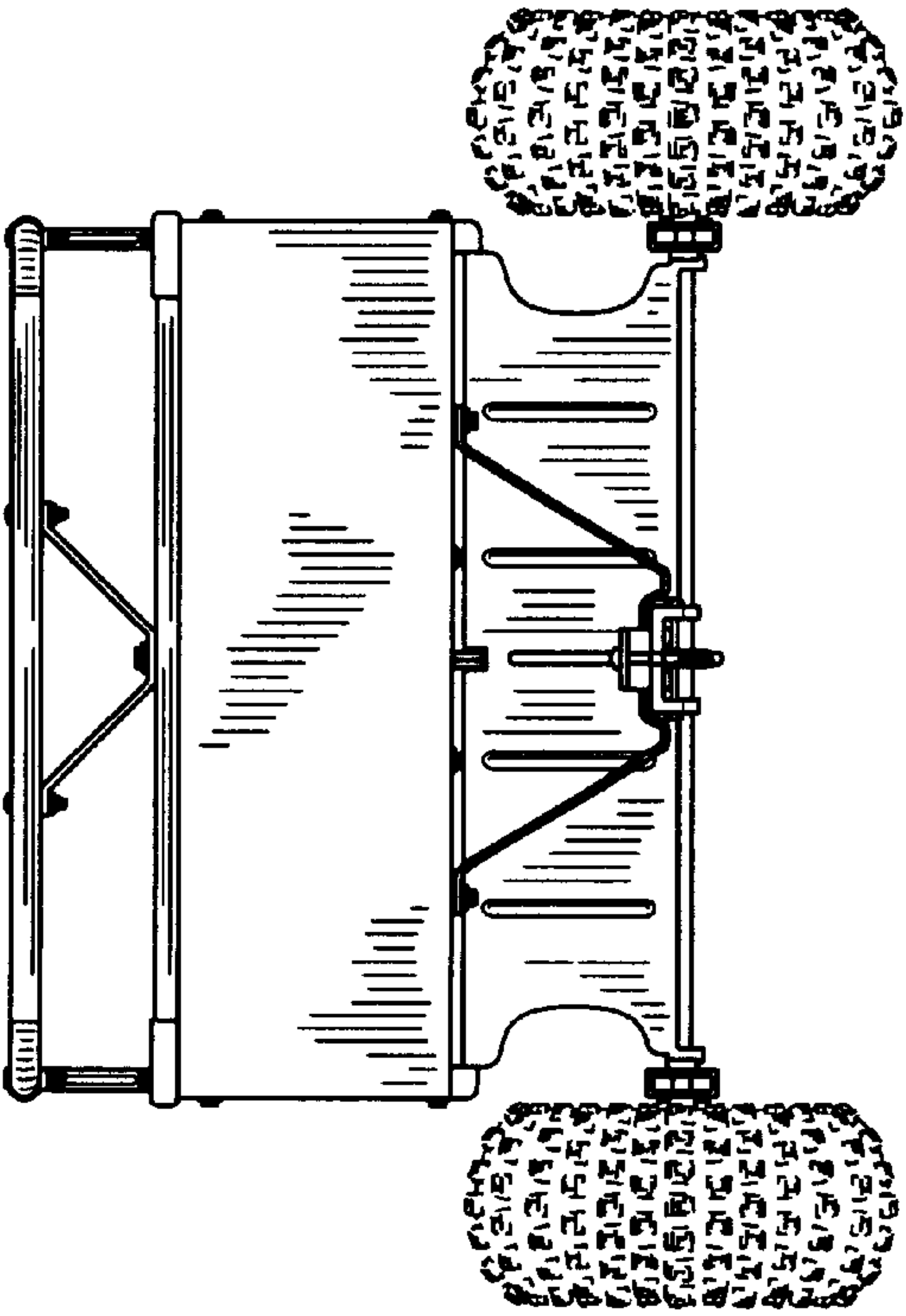

FIG. 3

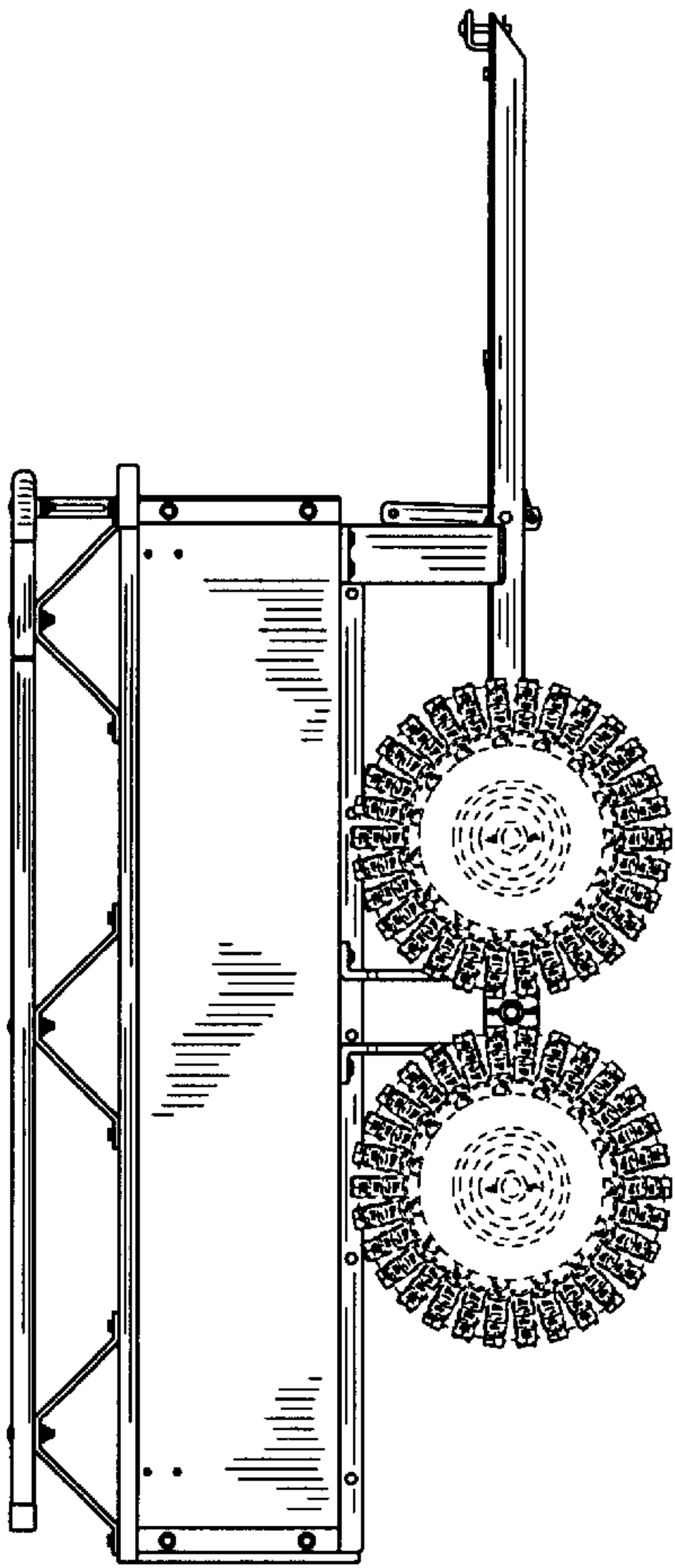

FIG. 4

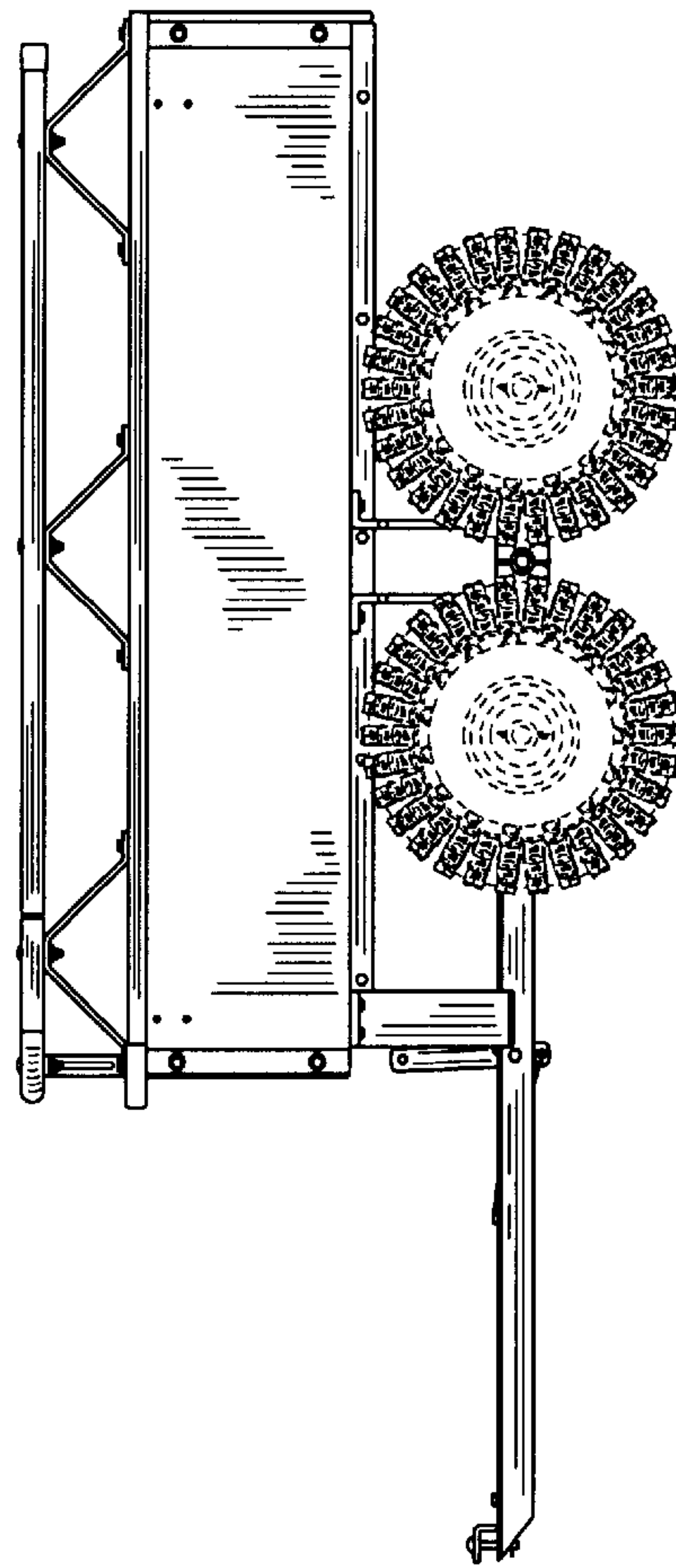

FIG. 5

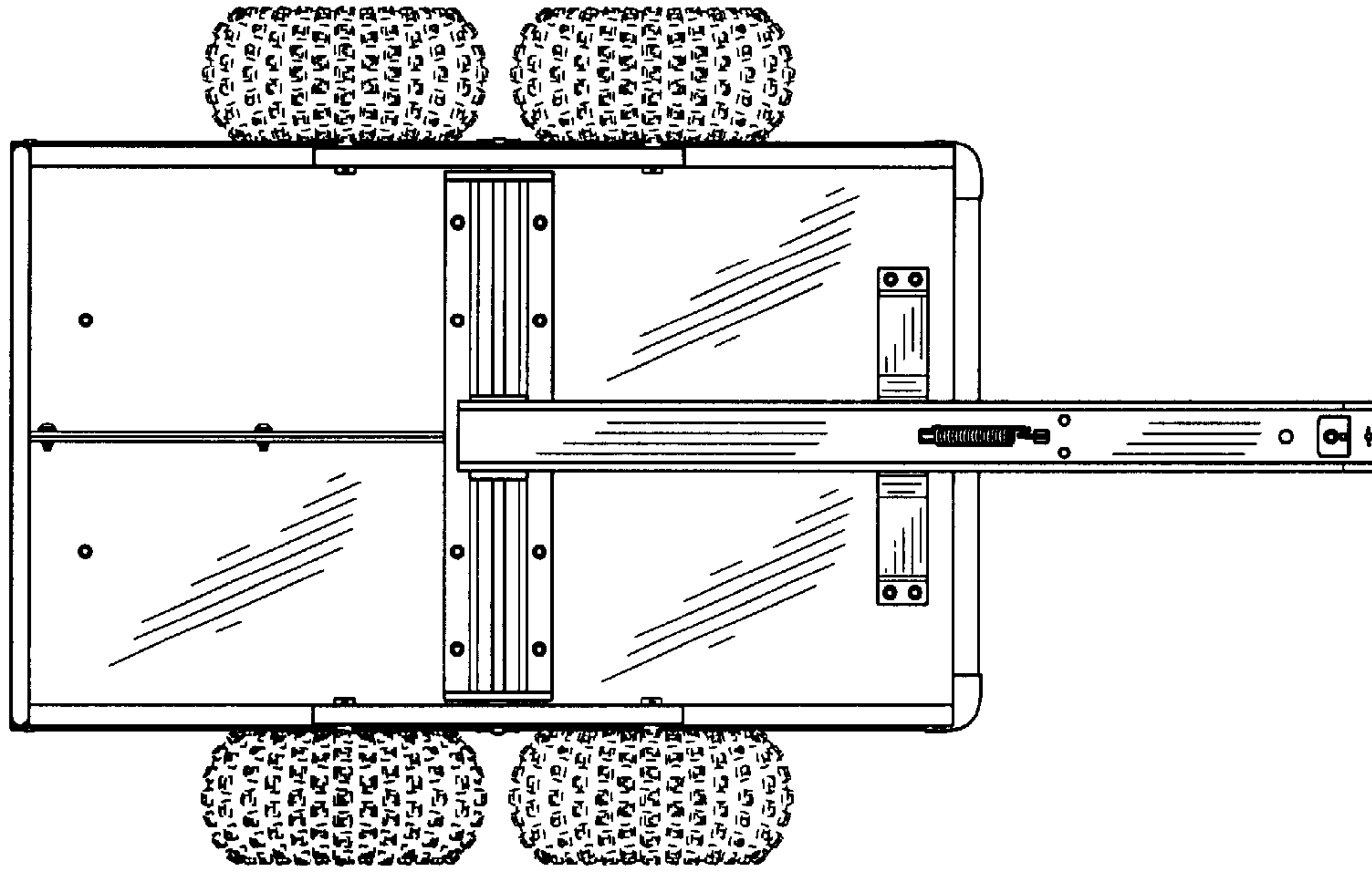

FIG. 6

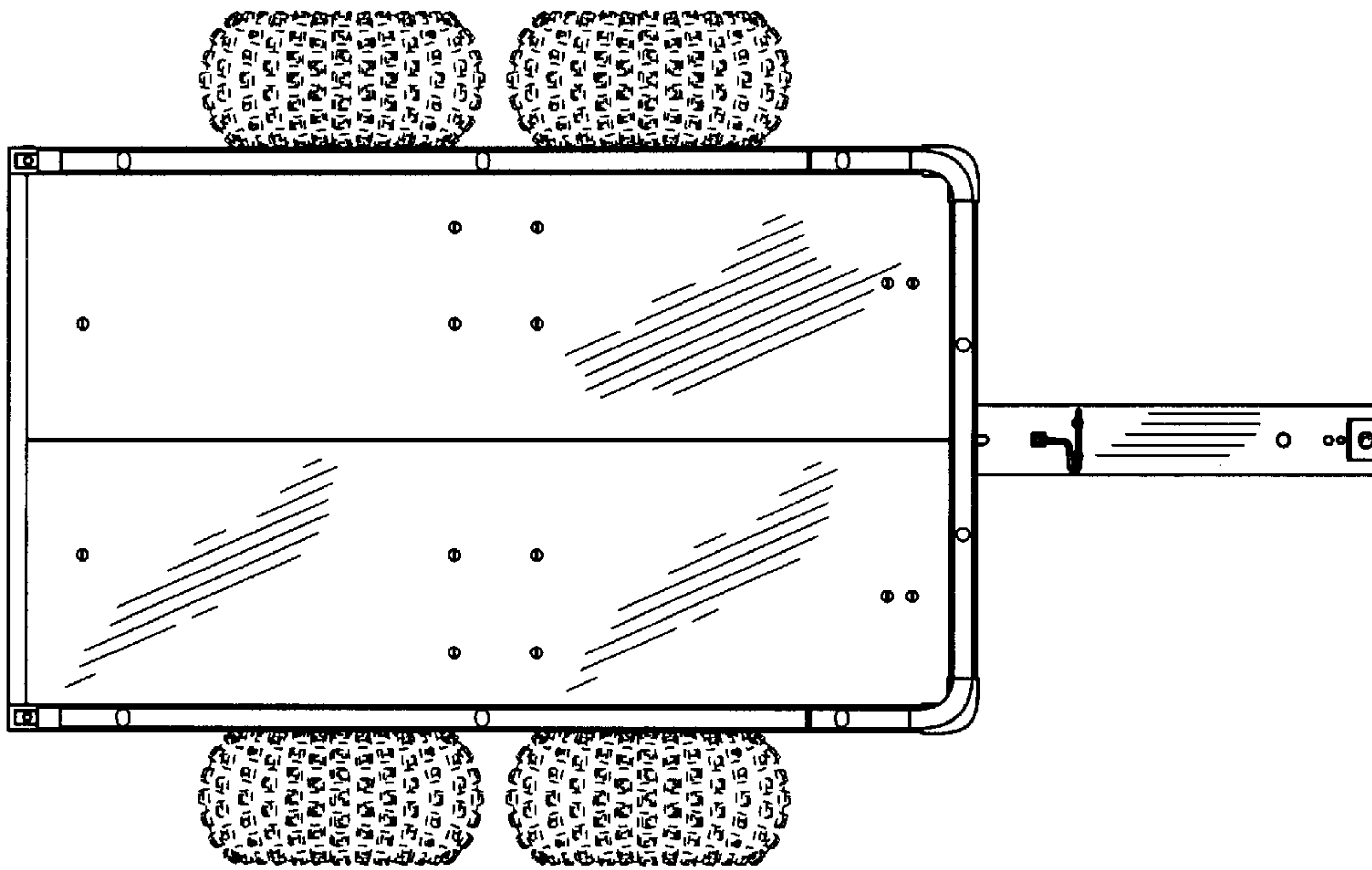

FIG. 7