



US00D513614S

(12) **United States Design Patent**  
**Tsao**

(10) **Patent No.:** **US D513,614 S**  
(45) **Date of Patent:** **\*\* Jan. 17, 2006**

- (54) **DISPLAY**
- (75) **Inventor:** **Chun-Lei Tsao, Taipei (TW)**
- (73) **Assignee:** **Hannspree, Inc., Taipei (TW)**
- (\*\*) **Term:** **14 Years**
- (21) **Appl. No.:** **29/213,616**
- (22) **Filed:** **Sep. 20, 2004**
- (51) **LOC (8) Cl.** ..... **14-02**
- (52) **U.S. Cl.** ..... **D14/371**
- (58) **Field of Classification Search** ..... D14/371-376,  
D14/125-129; 341/12; 345/104, 156, 168,  
345/173, 901-905; 248/917-924; 348/180,  
348/184, 325, 739; 349/1, 2, 11, 62; 40/594;  
312/204  
See application file for complete search history.

- D473,556 S \* 4/2003 Zuege et al. .... D14/371
- D476,653 S \* 7/2003 Zuege et al. .... D14/371
- D484,880 S \* 1/2004 Chiang ..... D14/371
- D495,333 S \* 8/2004 Borsboom ..... D14/371
- D495,705 S \* 9/2004 Borsboom ..... D14/371

\* cited by examiner

*Primary Examiner*—Freda S. Nunn  
(74) *Attorney, Agent, or Firm*—Sughrue Mion, PLLC

(57) **CLAIM**

The ornamental design for a display, as shown and described.

**DESCRIPTION**

- FIG. 1 is a perspective view of a display showing the new design.
- FIG. 2 is a front view thereof.
- FIG. 3 is a rear view thereof.
- FIG. 4 is a left side view thereof.
- FIG. 5 is a right side view thereof.
- FIG. 6 is a top view thereof; and,
- FIG. 7 is a bottom view thereof.

(56) **References Cited**

**U.S. PATENT DOCUMENTS**

- 5,072,998 A \* 12/1991 Oh ..... 312/204
- 5,564,209 A \* 10/1996 Zagnoli ..... 40/594
- D473,229 S \* 4/2003 Zuege et al. .... D14/371

**1 Claim, 7 Drawing Sheets**

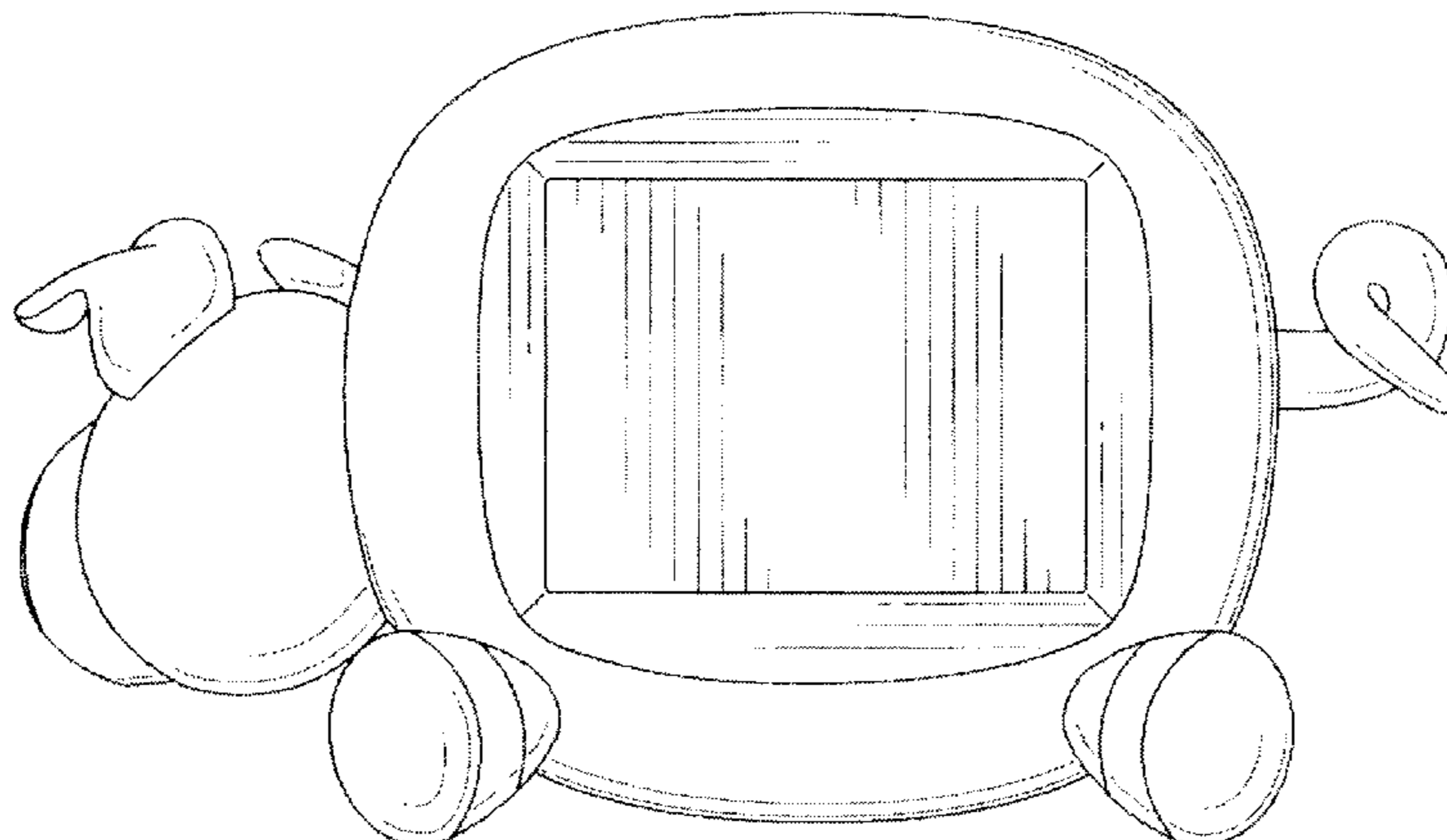
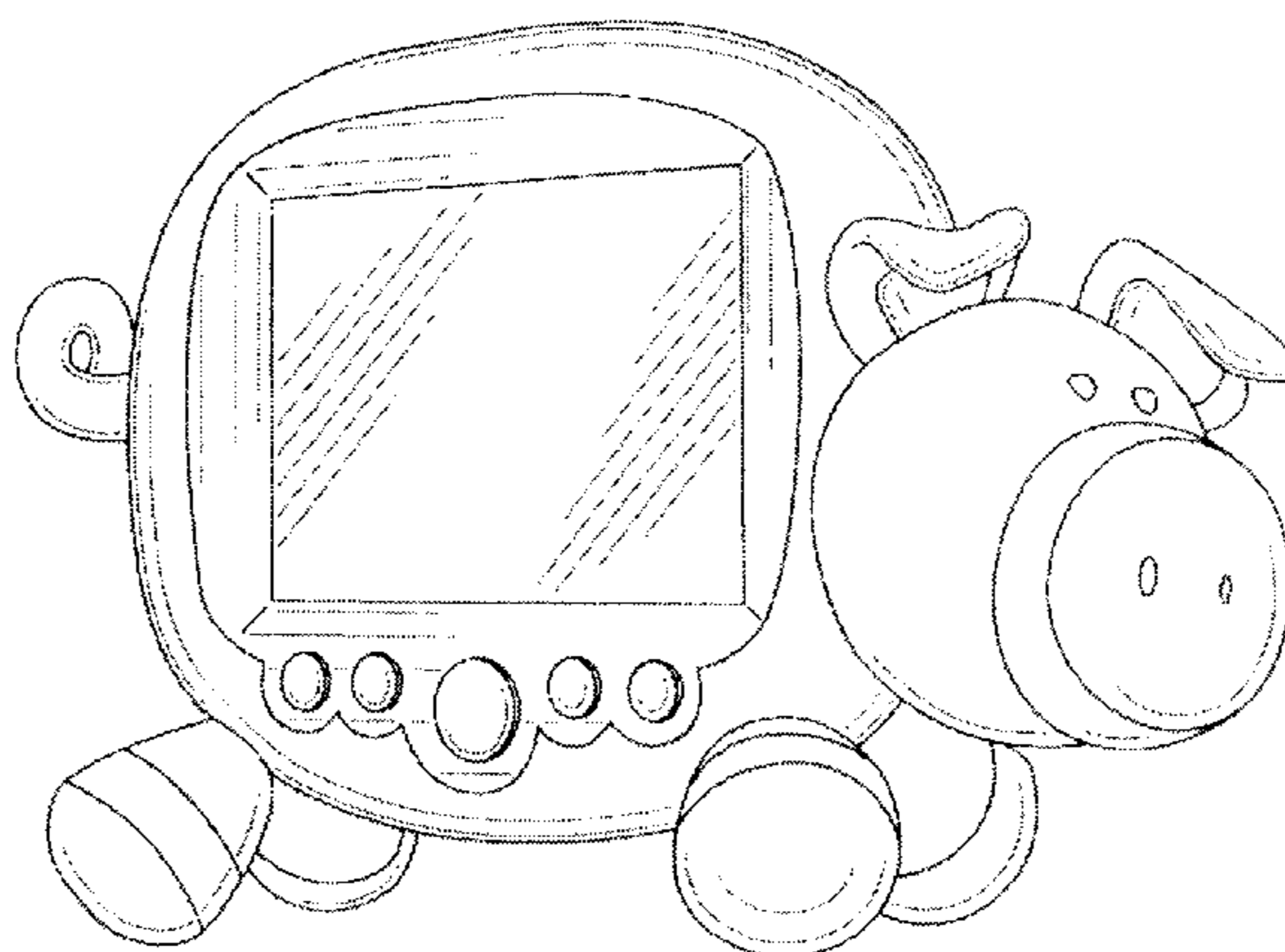

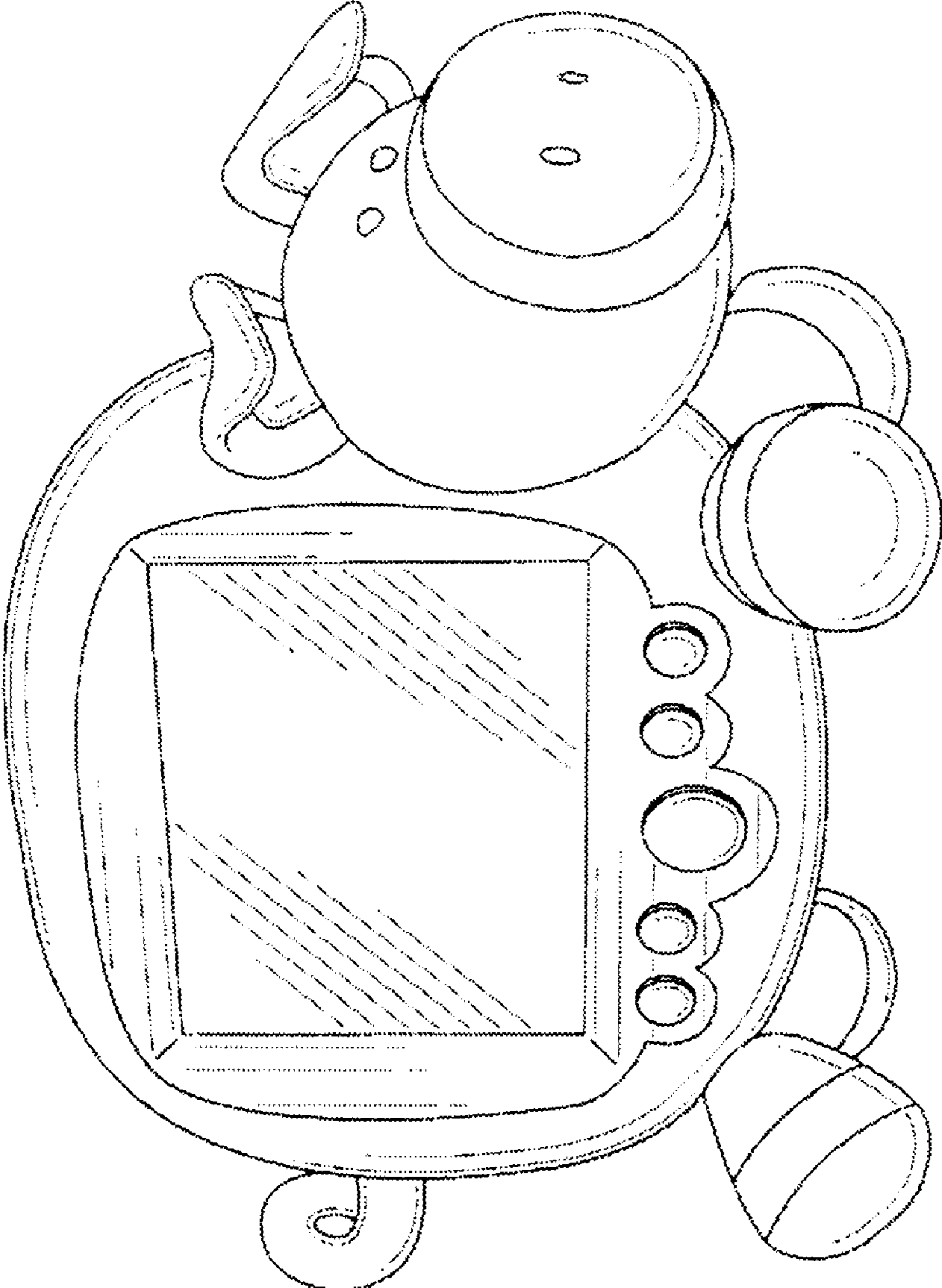

FIG. 1

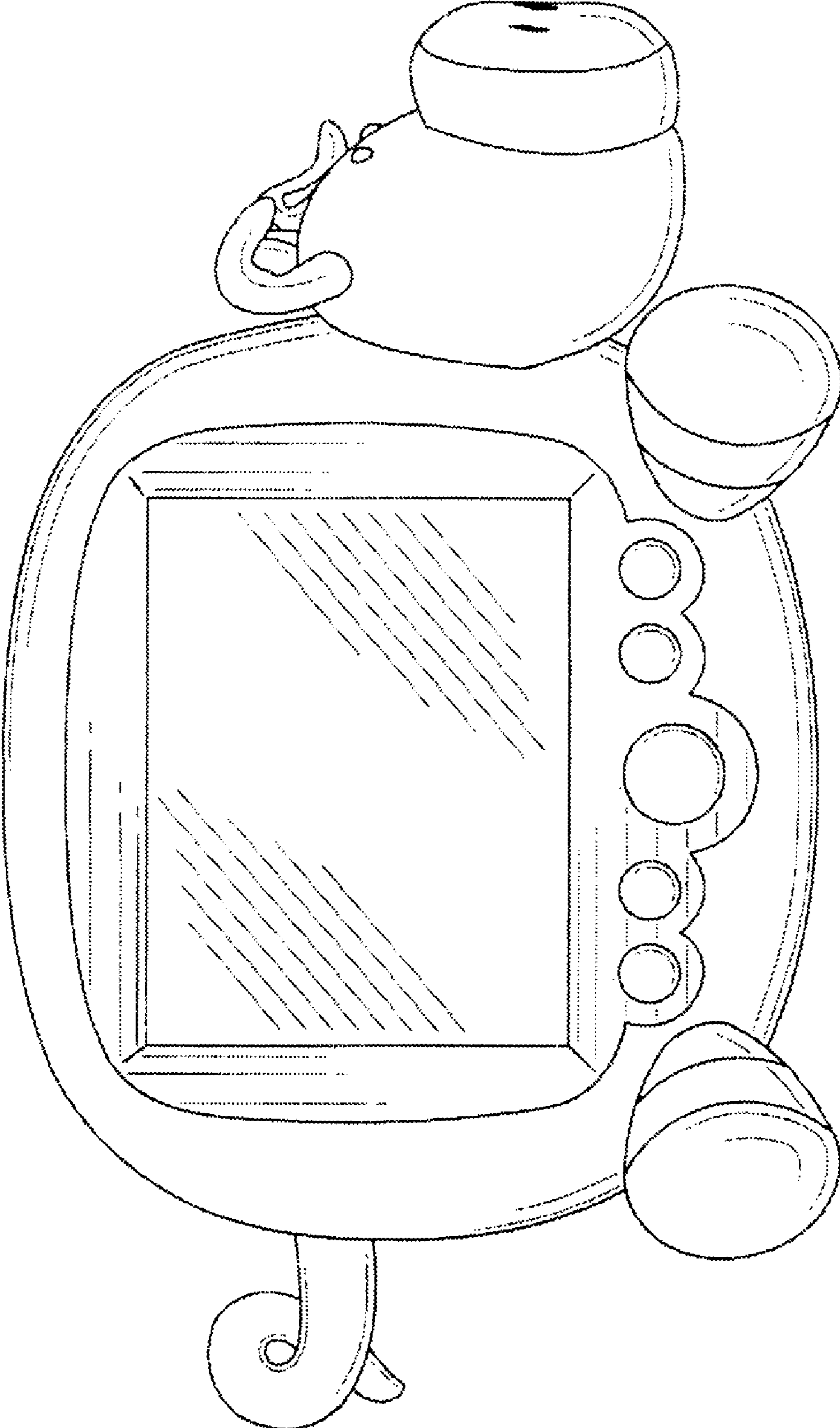

FIG. 2

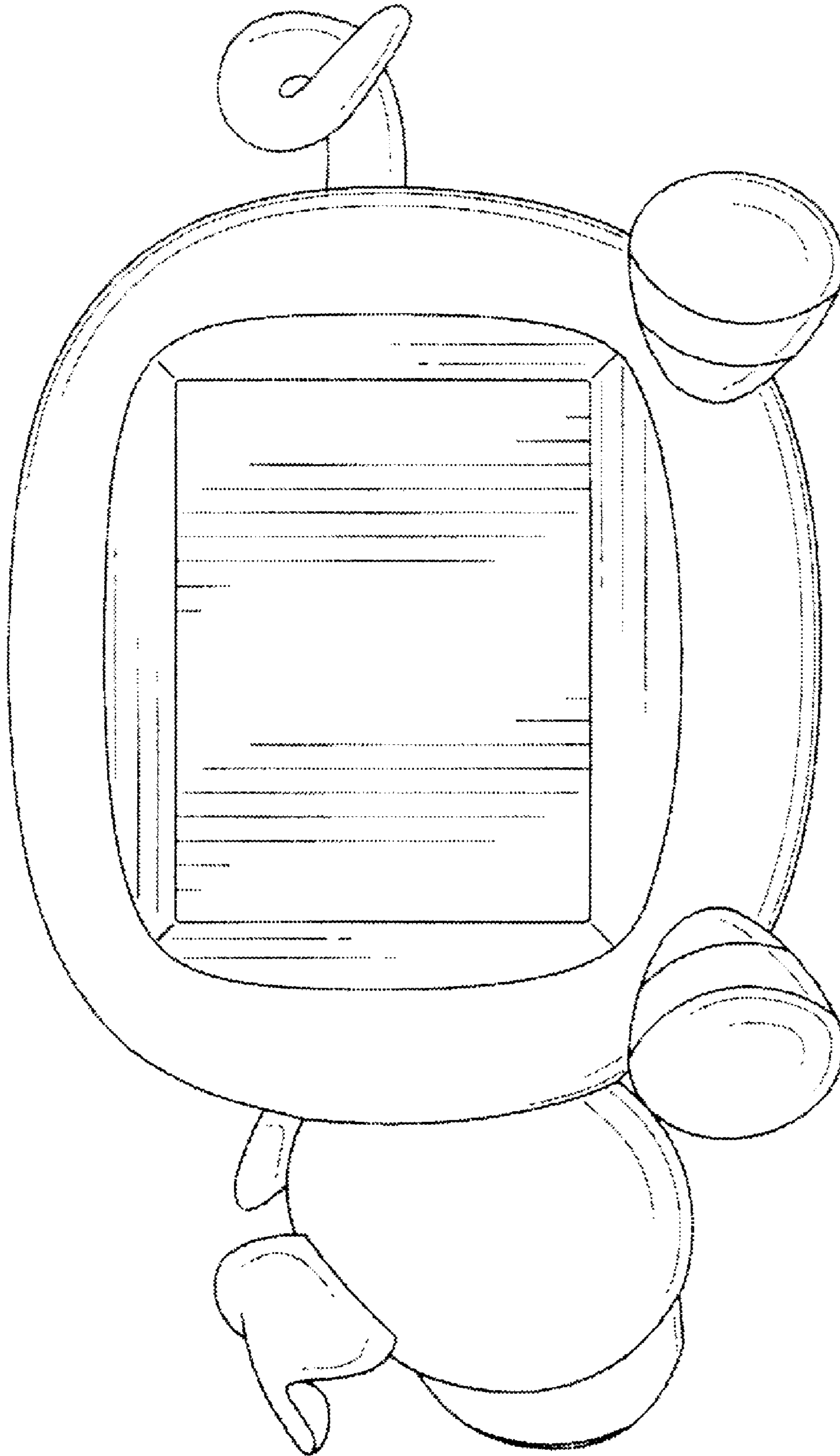

FIG. 3



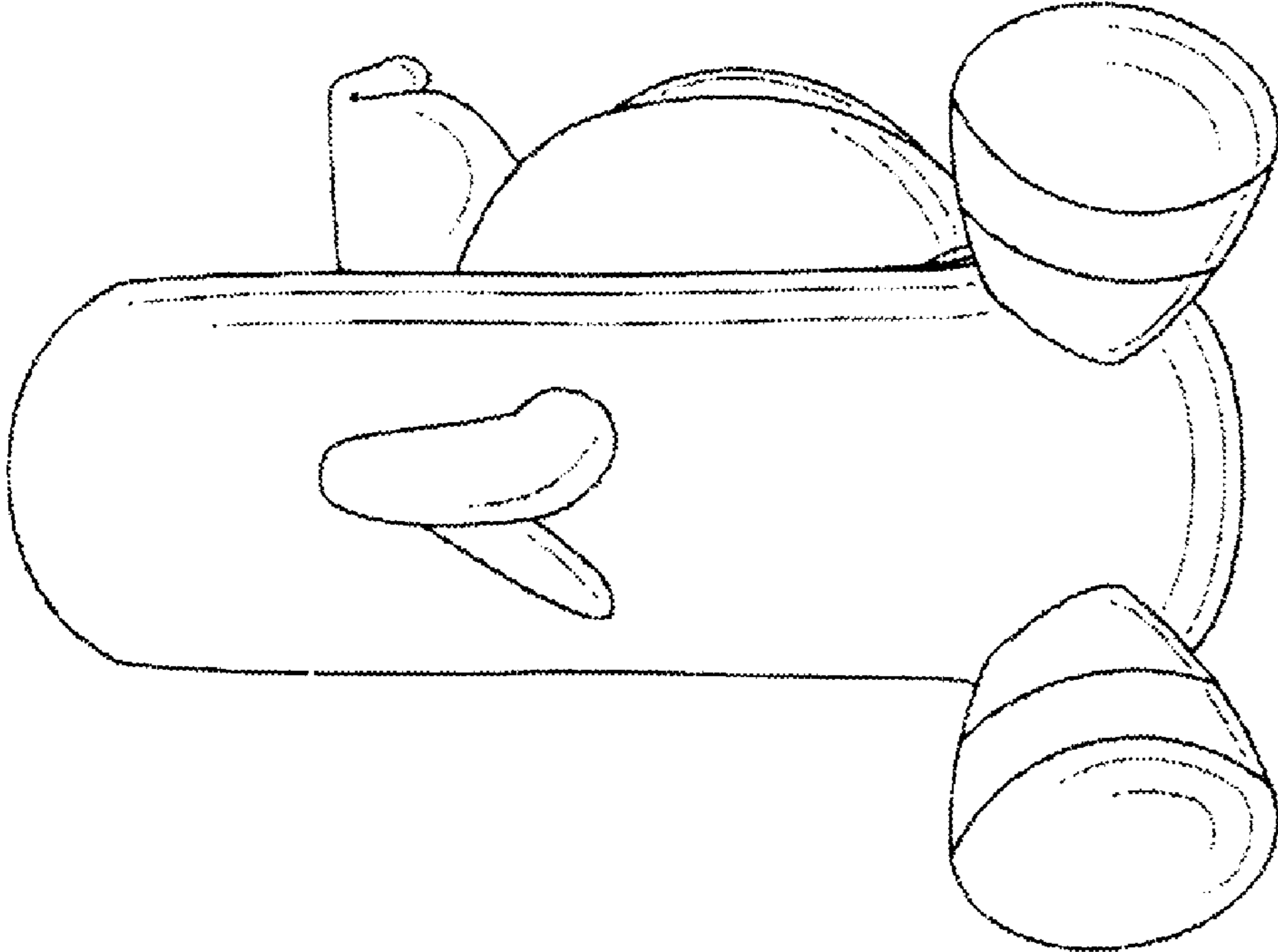

FIG. 4

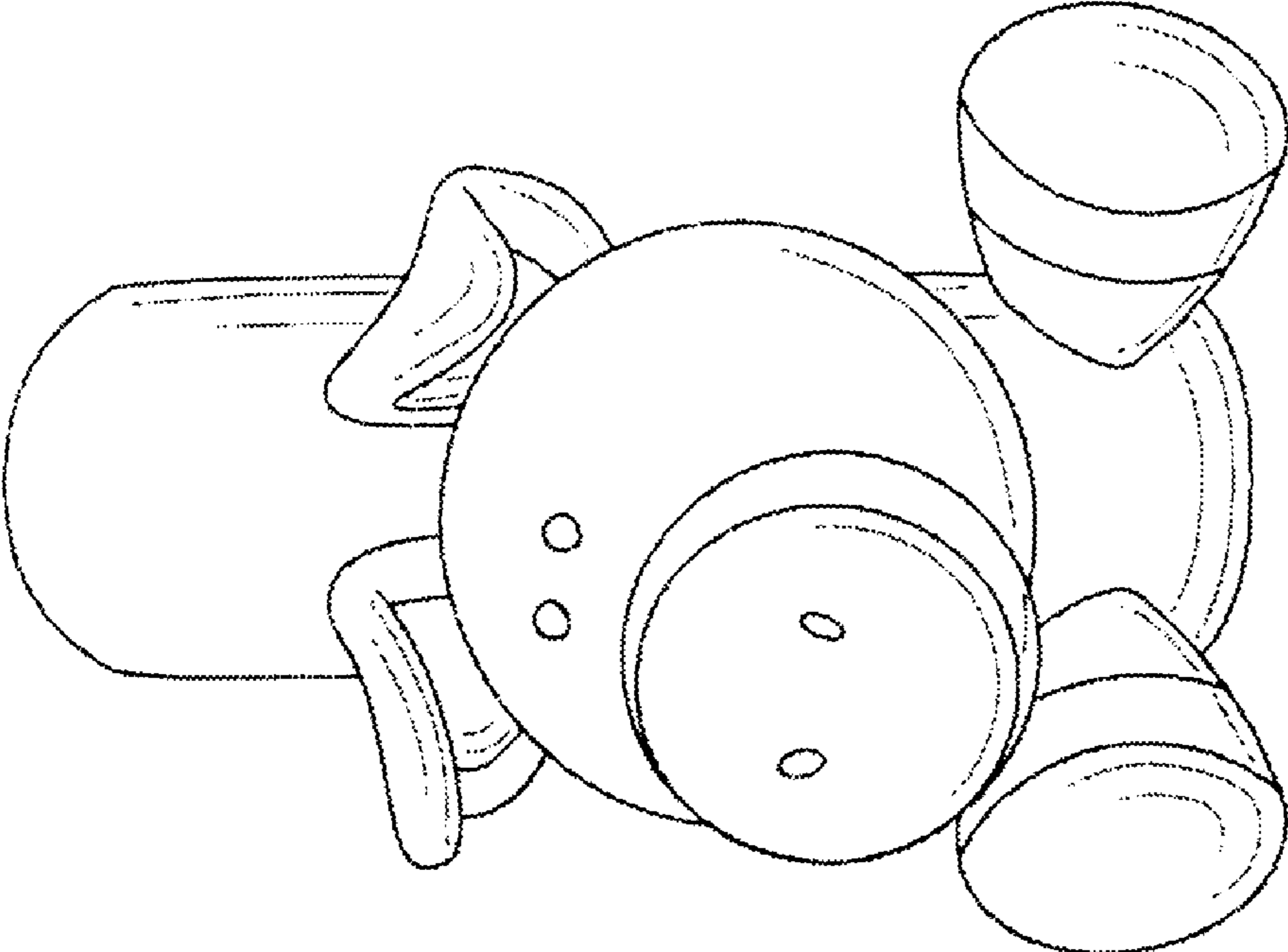

FIG. 5

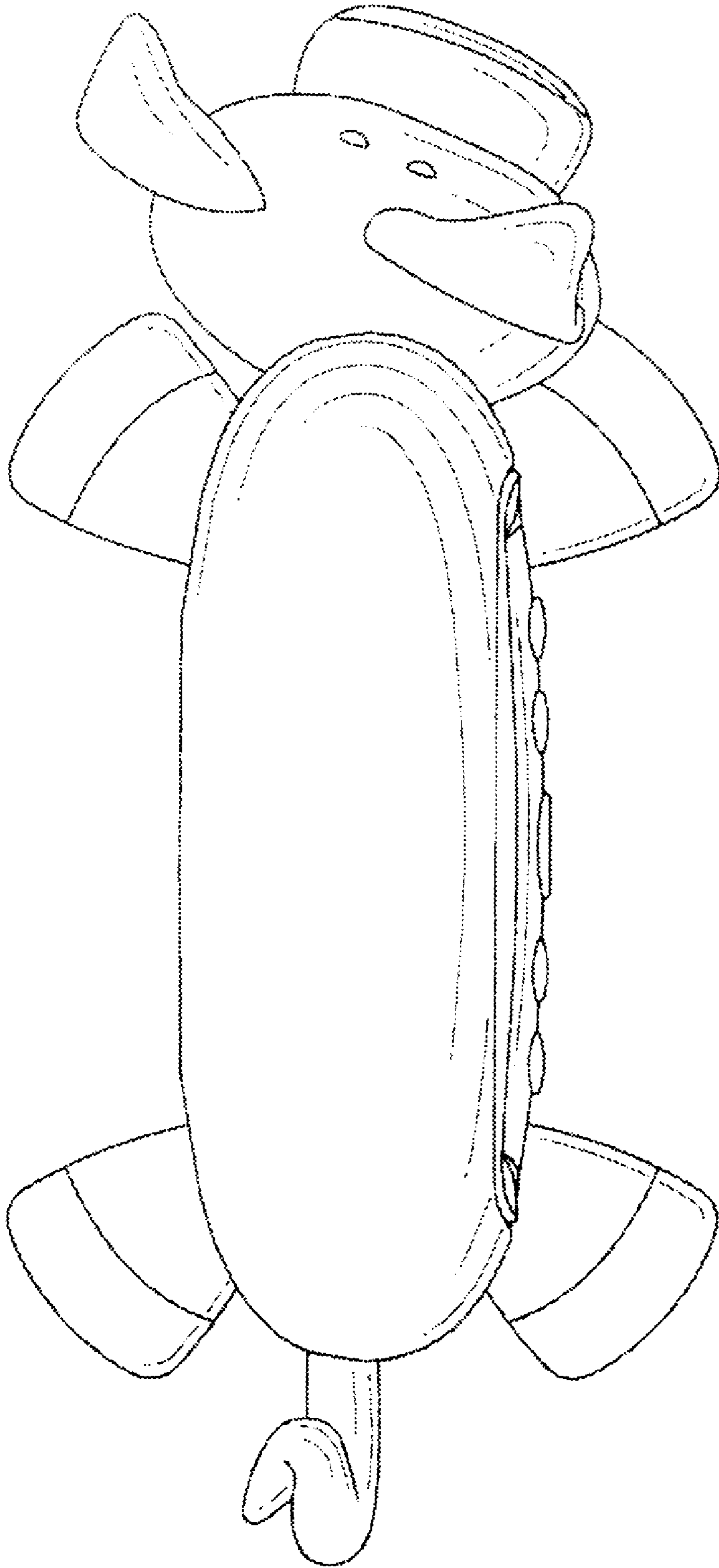

FIG. 6

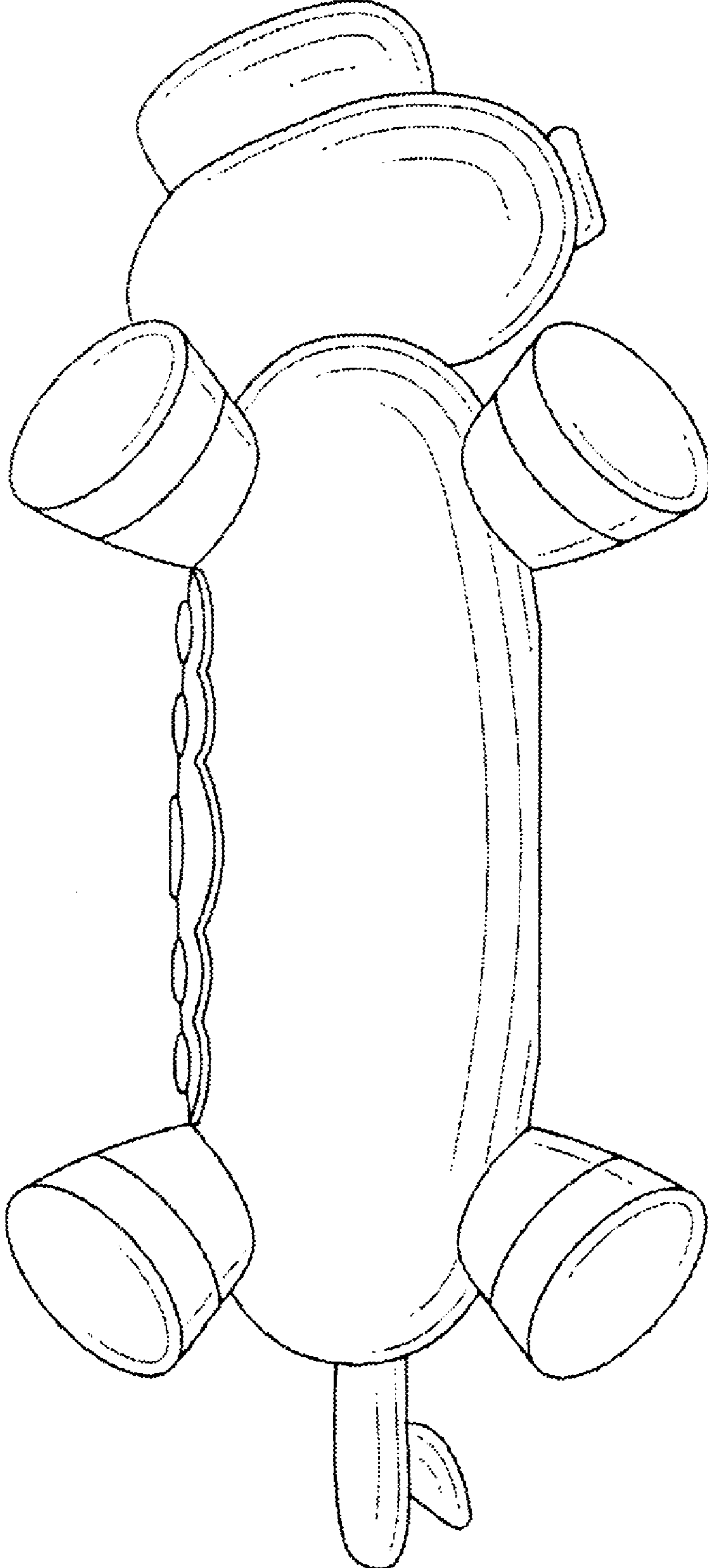

FIG. 7