



US00D513577S

(12) **United States Design Patent** (10) **Patent No.:** **US D513,577 S**  
**McLean et al.** (45) **Date of Patent:** **\*\* Jan. 17, 2006**

(54) **SCISSORS**

(75) Inventors: **Mark A. McLean**, Wausau, WI (US);  
**Jason Wolf**, Wausau, WI (US);  
**Christopher Robert Carlson**,  
Waterloo, WI (US)

(73) Assignee: **Alterra Holdings Corporation**, Tigard,  
OR (US)

(\*\*) Term: **14 Years**

(21) Appl. No.: **29/225,294**

(22) Filed: **Mar. 14, 2005**

**Related U.S. Application Data**

(62) Division of application No. 29/182,367, filed on May 23,  
2003, now Pat. No. Des. 505,054.

(51) **LOC (8) Cl.** ..... **08-05**

(52) **U.S. Cl.** ..... **D8/57**

(58) **Field of Classification Search** ..... D8/57,  
D8/100, 103; 7/135, 136; 30/131, 195, 358,  
30/229-262

See application file for complete search history.

(56) **References Cited**

**U.S. PATENT DOCUMENTS**

144,251 A	11/1873	Breeden
154,637 A	9/1874	Breeden
176,519 A	4/1876	Does
1,326,299 A	12/1919	Smit
1,912,652 A	6/1933	Nutt
D101,791 S	11/1936	Rauh
2,184,909 A	12/1939	Crompton
2,217,726 A	10/1940	Brisson
2,343,527 A	3/1944	Boyle
2,380,075 A	7/1945	Rose
2,382,281 A	8/1945	Amis

D180,004 S	4/1957	Anderson
3,869,792 A	3/1975	Laurenti
D278,117 S	3/1985	Smith
4,666,451 A	5/1987	Samaria
4,744,147 A	5/1988	Modin
D318,780 S	8/1991	Bendickson et al.
5,146,810 A	9/1992	Mueller
D350,466 S	9/1994	Ramsey et al.
D353,087 S	12/1994	Ramsey et al.
D383,957 S	9/1997	Cornell
D393,192 S	4/1998	Cornell
D395,992 S	7/1998	Bennett et al.
D421,375 S	3/2000	Carlson et al.
D451,355 S	12/2001	Dean et al.

*Primary Examiner*—Clare E Heflin

(74) *Attorney, Agent, or Firm*—Foley & Lardner

(57) **CLAIM**

We claim the ornamental design for scissors, as shown and described.

**DESCRIPTION**

FIG. 1 is a perspective view of scissors showing our new design;

FIG. 2 is a left side view thereof;

FIG. 3 is a right side view thereof;

FIG. 4 is a top plan view thereof;

FIG. 5 is a bottom plan view thereof;

FIG. 6 is a front end view thereof;

FIG. 7 is a rear end view thereof;

FIG. 8 is another perspective view of the scissors of FIG. 1;

FIG. 9 is a left side view thereof; and,

FIG. 10 is a right side view thereof.

The ornamental design which is claimed is shown in solid lines in the drawings. The broken lines in the drawings are for illustrative purposes only and form no part of the claimed design.

**1 Claim, 4 Drawing Sheets**

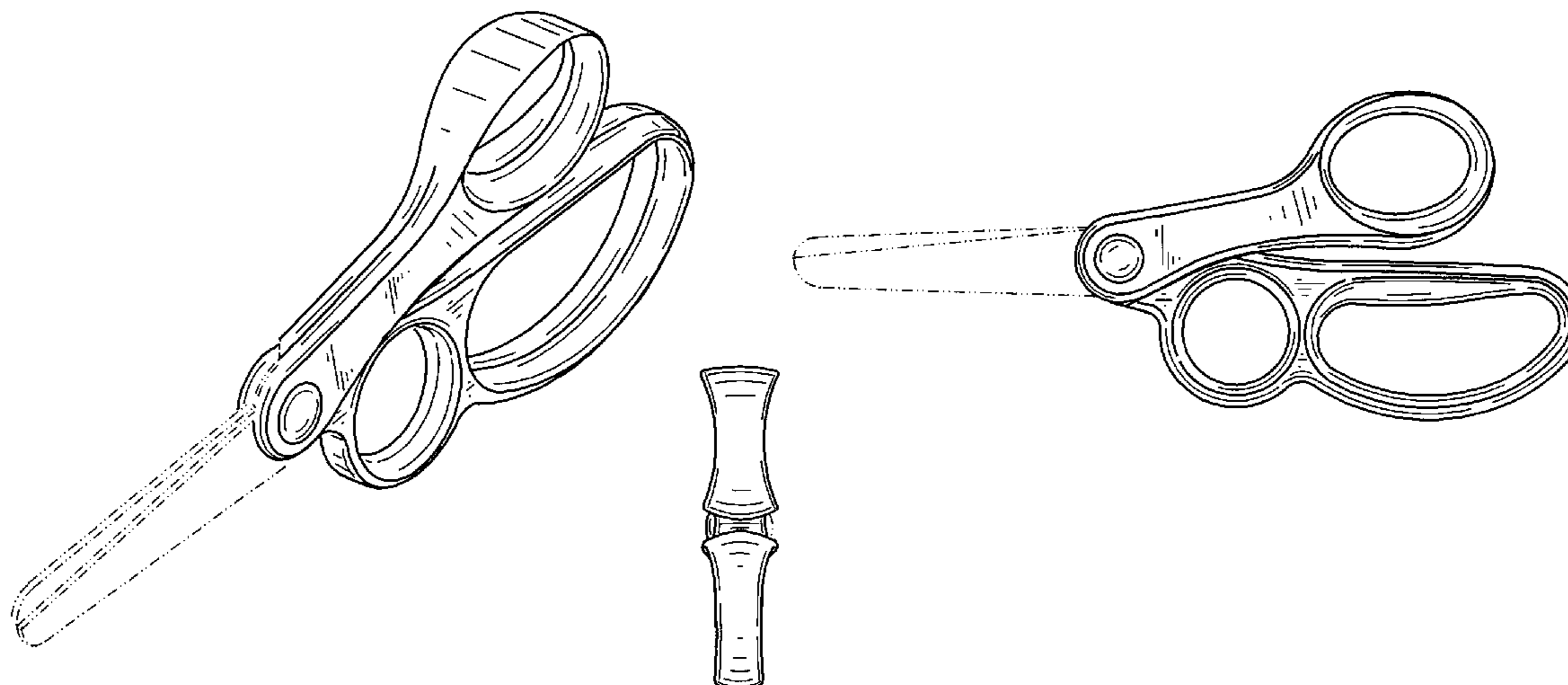

FIG. 1

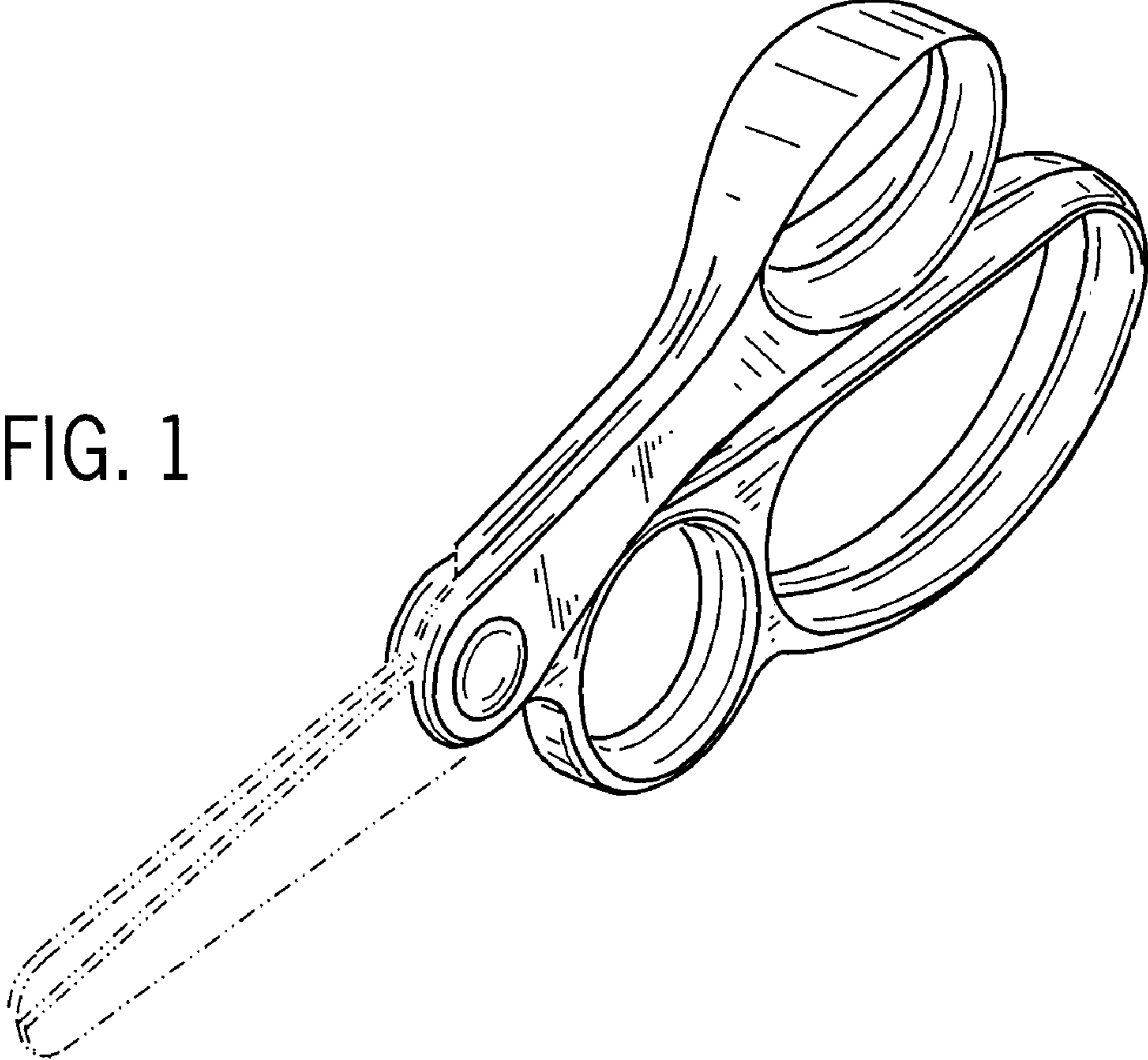
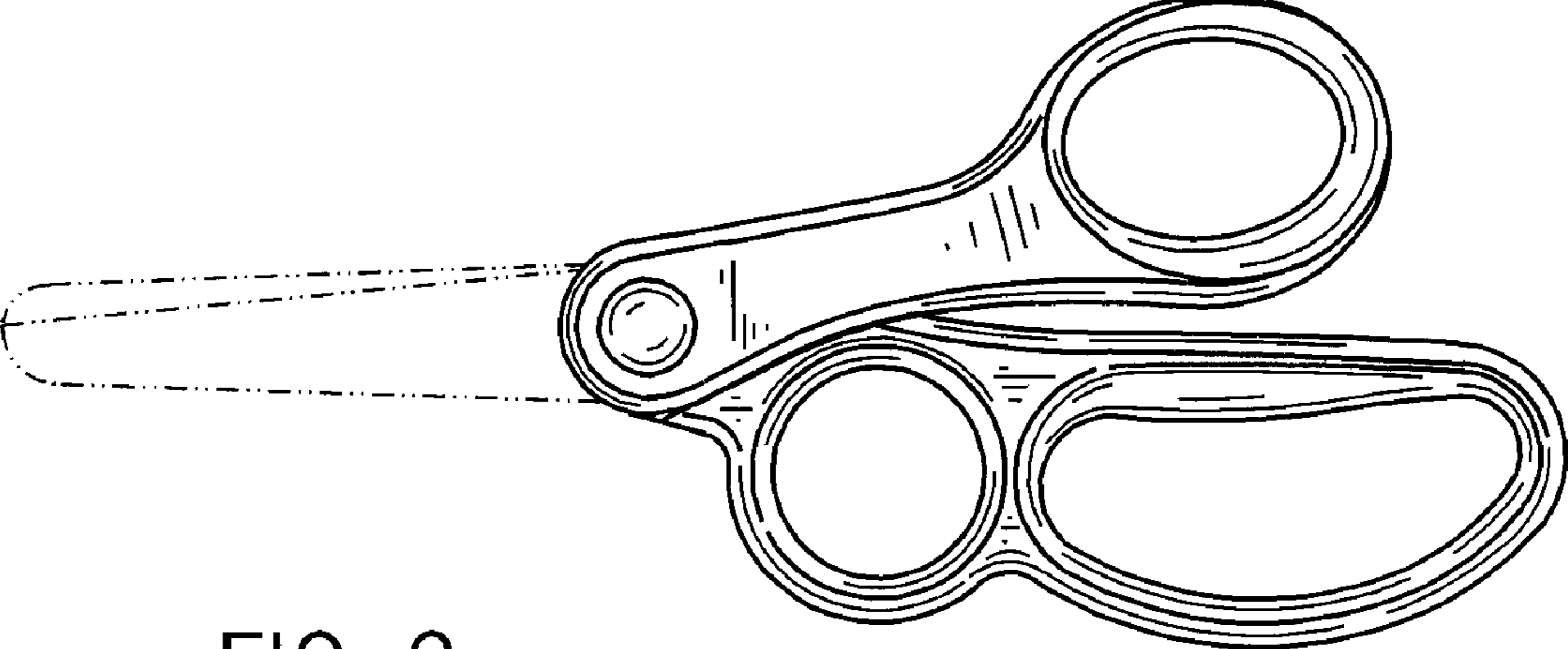

FIG. 2



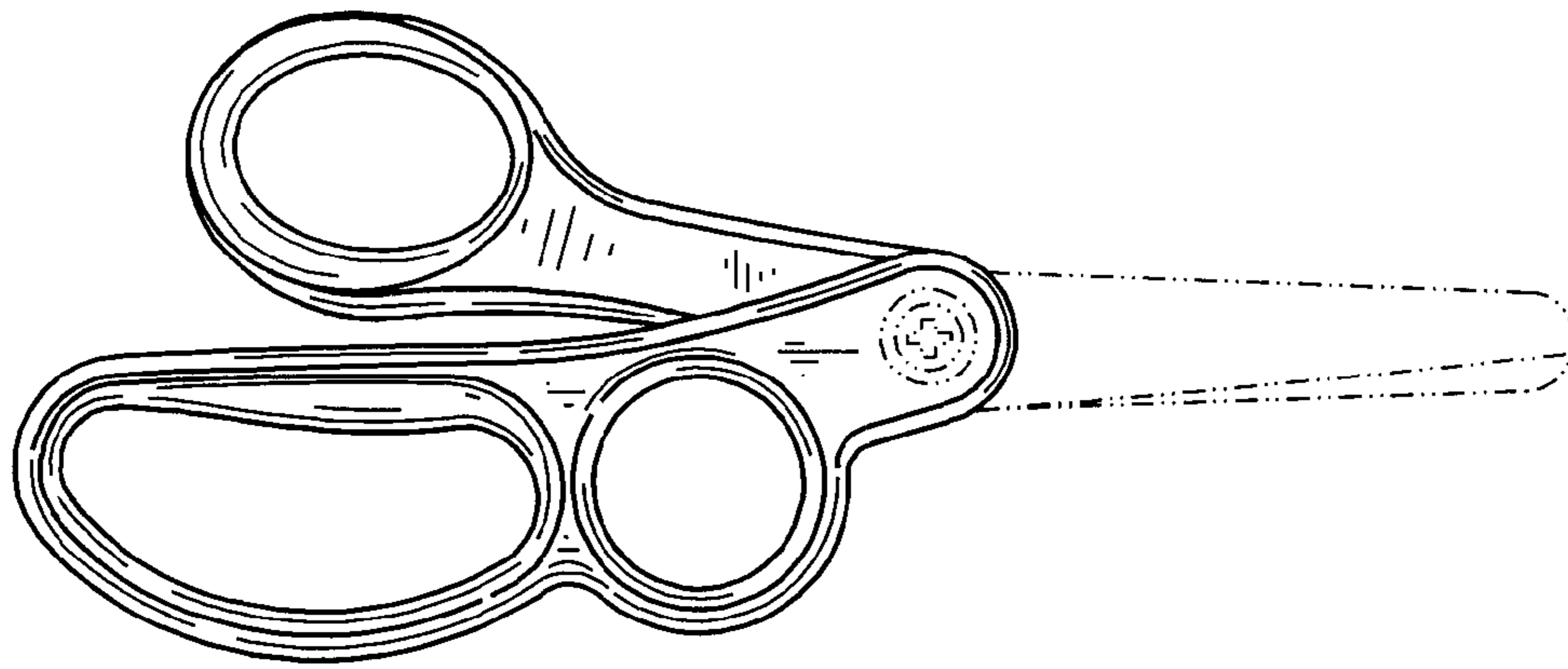

FIG. 3

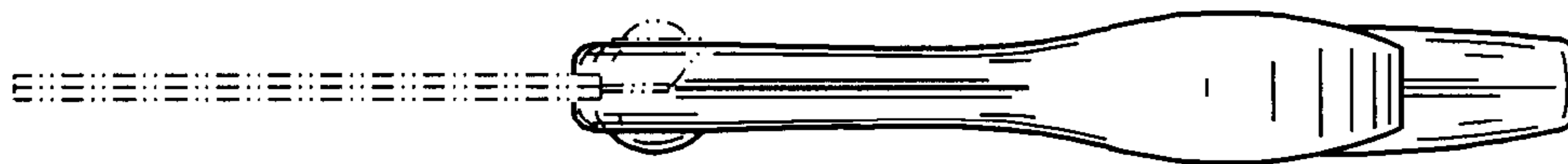

FIG. 4

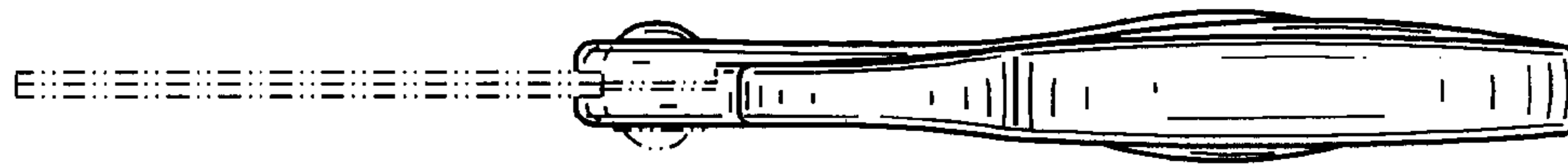

FIG. 5

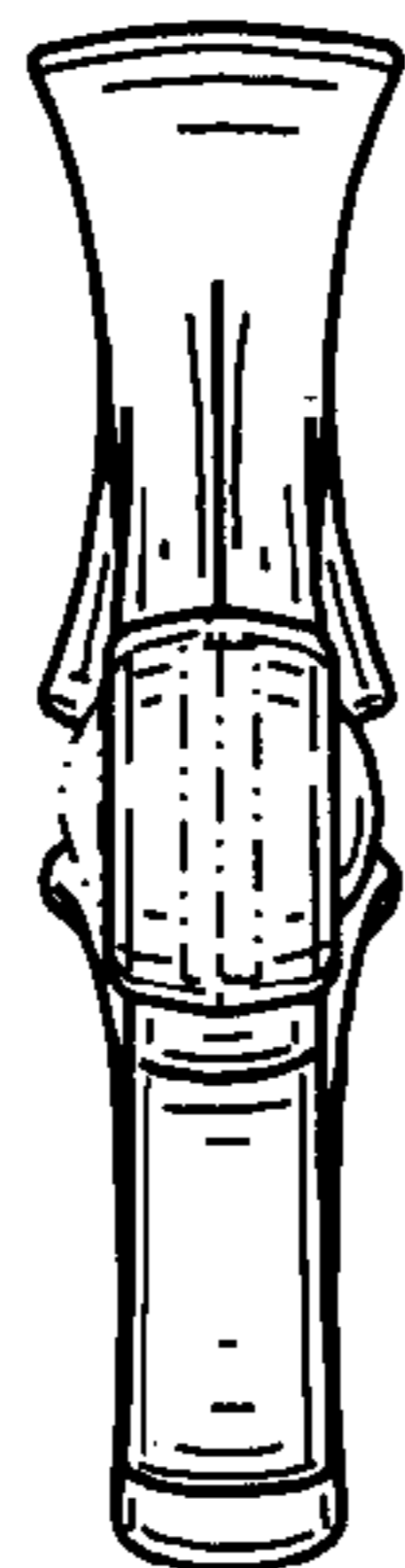

FIG. 6

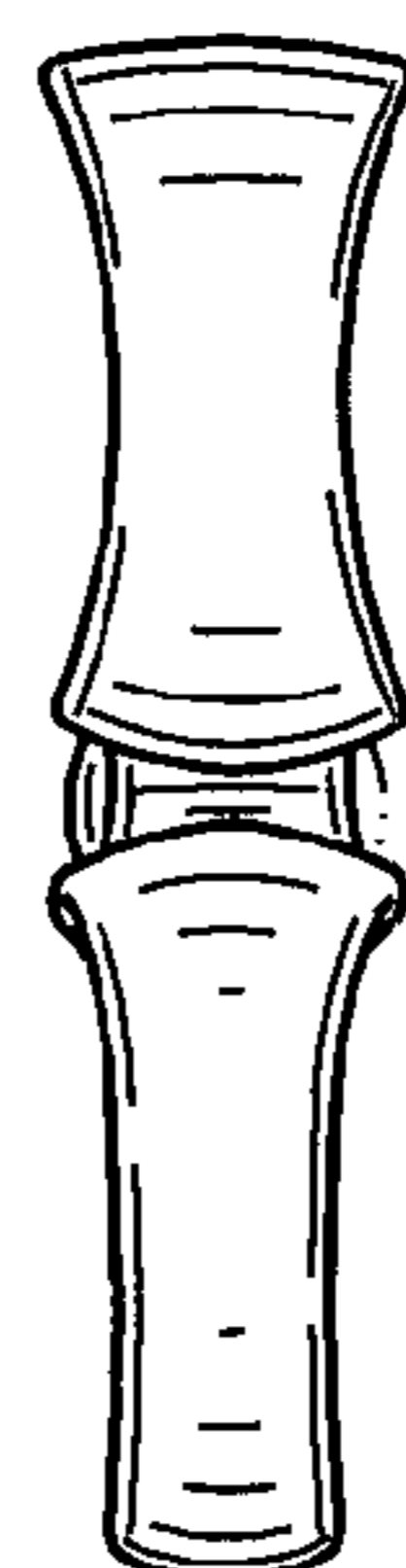

FIG. 7

FIG. 8

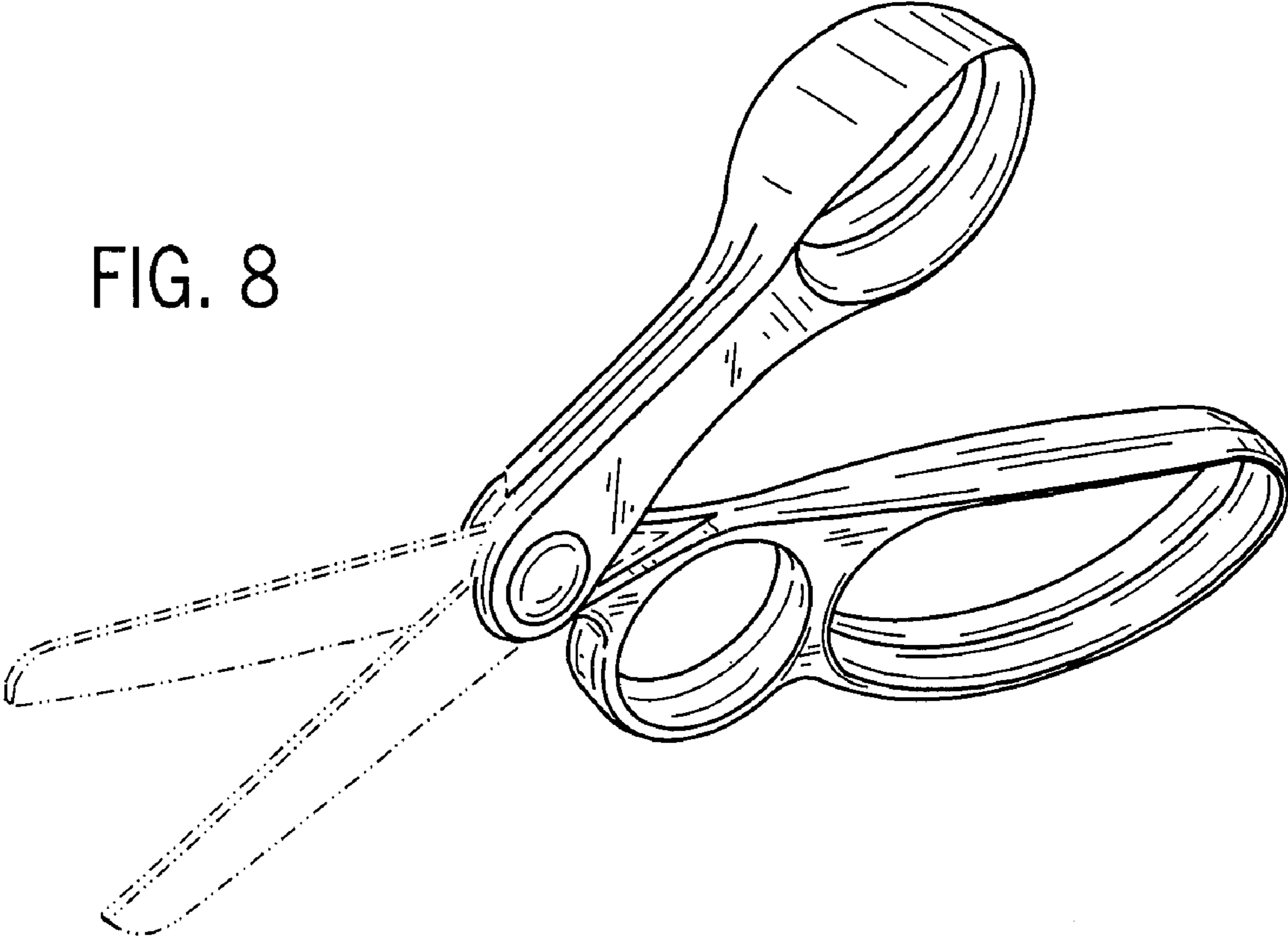
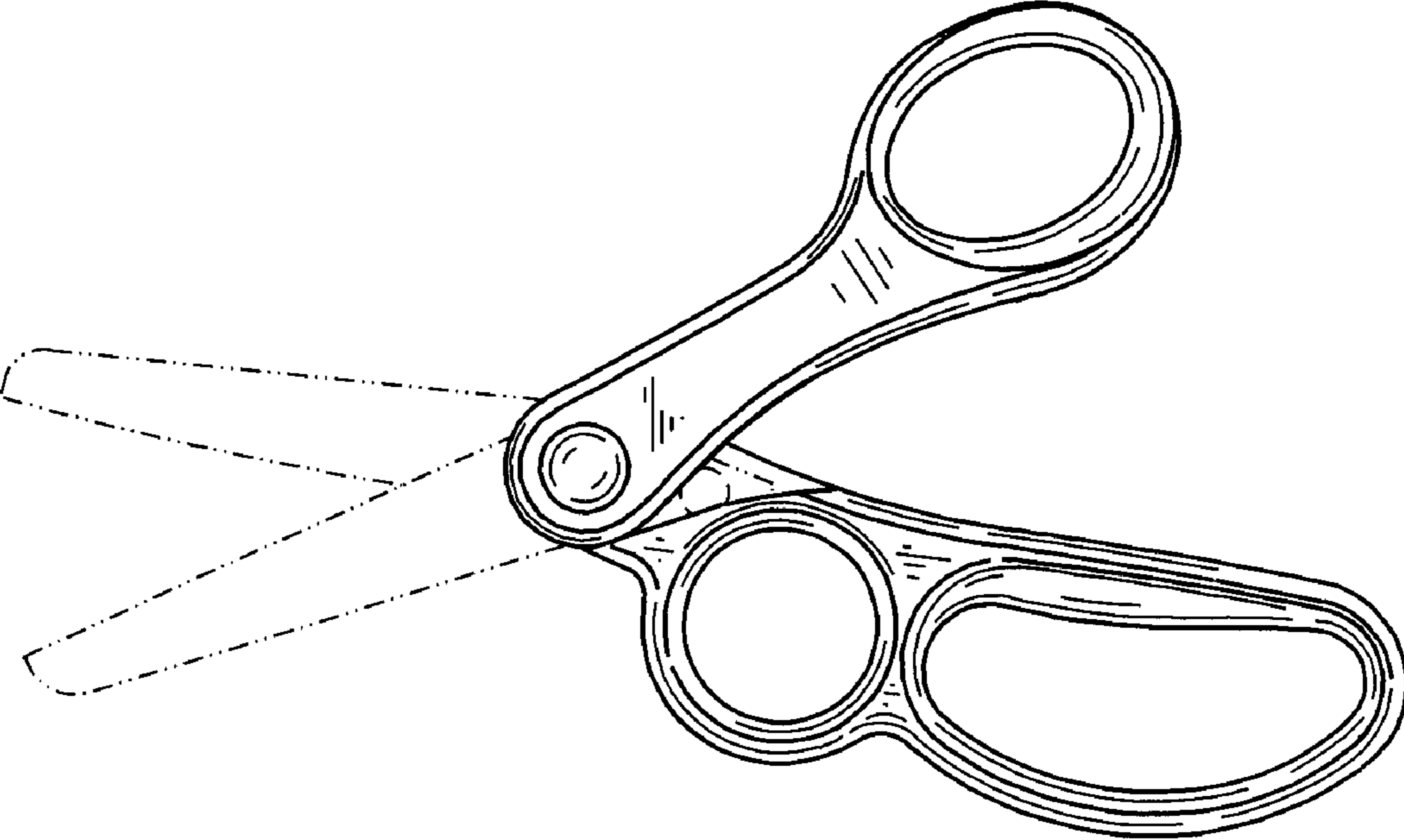

FIG. 9



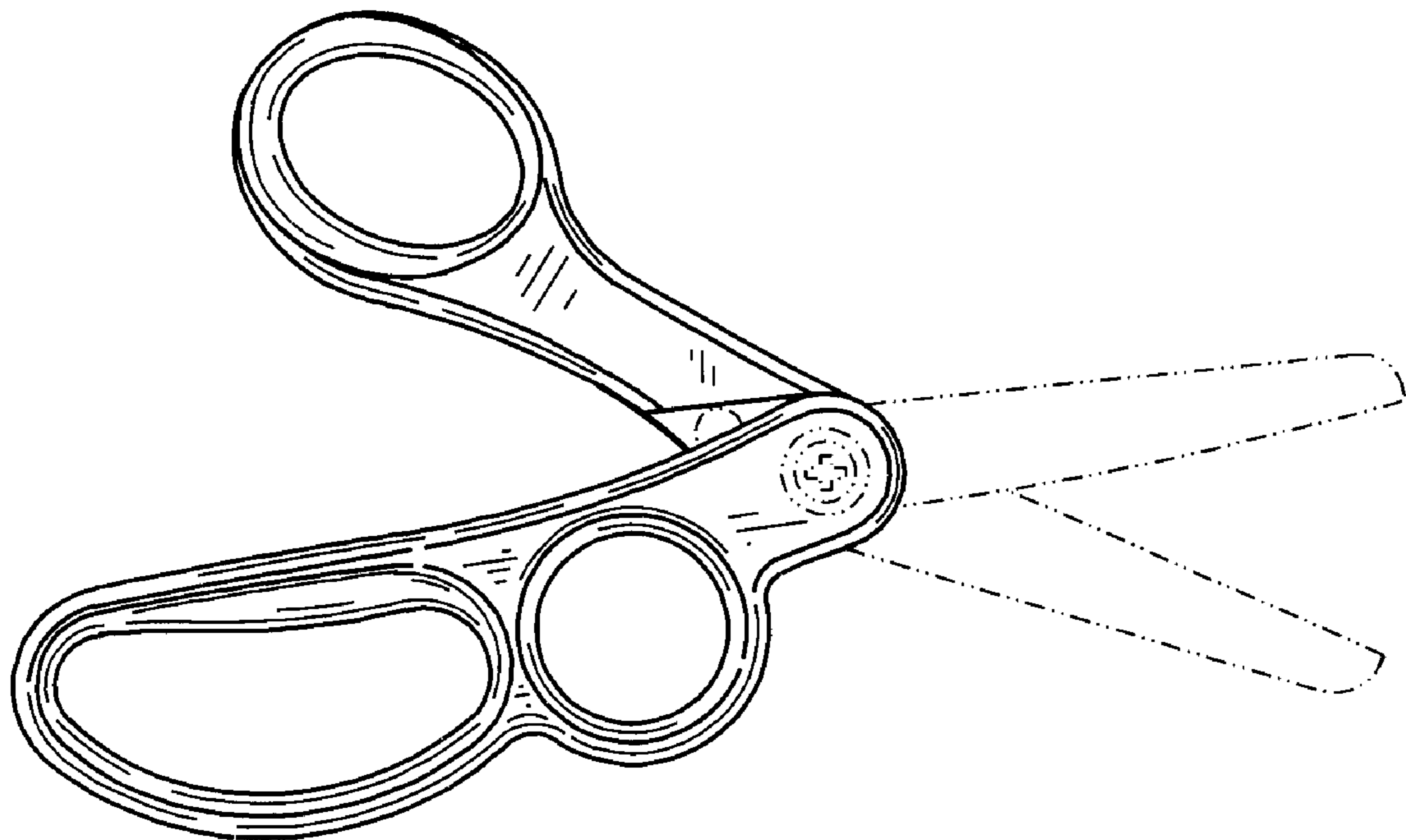

FIG. 10