



US00D513383S

(12) **United States Design Patent** (10) **Patent No.:** **US D513,383 S**
Glander et al. (45) **Date of Patent:** **** Jan. 3, 2006**

(54) **SERVING TRAY LID**

(57) **CLAIM**

(75) Inventors: **Susan Ann Glander**, Birchwood, MN (US); **Troy Alan Hill**, Wyomissing, PA (US)

The ornamental design for a serving tray lid, as shown and described.

(73) Assignee: **Tyco Plastic Services AG**, Schaffhausen (CH)

DESCRIPTION

(**) Term: **14 Years**

FIG. 1 illustrates a perspective view of a lid employing an ornamental design in accordance with the present invention; FIG. 2 is a side view of the lid of FIG. 1, the opposite side being a mirror image thereof; FIG. 3 is a top view of the lid of FIG. 1; FIG. 4 is a bottom view of the lid of FIG. 1; FIG. 5 illustrates a perspective view of a lid employing an ornamental design in accordance with the present invention; FIG. 6 is a side view of the lid of FIG. 5, the opposite side being a mirror image thereof; FIG. 7 is a top view of the lid of FIG. 5; FIG. 8 is a bottom view of the lid of FIG. 5; FIG. 9 illustrates a perspective view of a lid employing an ornamental design in accordance with the present invention; FIG. 10 is a side view of the lid of FIG. 9, the opposite side being a mirror image thereof; FIG. 11 is a top view of the lid of FIG. 9; FIG. 12 is a bottom view of the lid of FIG. 9; FIG. 13 illustrates a perspective view of a lid employing an ornamental design in accordance with the present invention; FIG. 14 is a side view of the lid of FIG. 13, the opposite side being a mirror image thereof; FIG. 15 is a top view of the lid of FIG. 13; FIG. 16 is a bottom view of the lid of FIG. 13; FIG. 17 illustrates a perspective view of a lid employing an ornamental design in accordance with the present invention; FIG. 18 is a side view of the lid of FIG. 17, the opposite side being a mirror image thereof; FIG. 19 is a top view of the lid of FIG. 17; FIG. 20 is a bottom view of the lid of FIG. 17; FIG. 21 illustrates a perspective view of a lid employing an ornamental design in accordance with the present invention; FIG. 22 is a side view of the lid of FIG. 21, the opposite side being a mirror image thereof; FIG. 23 is a top view of the lid of FIG. 21; and, FIG. 24 is a bottom view of the lid of FIG. 21. The broken lines in the drawings are for illustrative purposes only and form no part of the claimed design.

(21) Appl. No.: **29/195,121**

(22) Filed: **Dec. 5, 2003**

(51) **LOC (8) Cl.** **09-07**

(52) **U.S. Cl.** **D9/435; D9/453**

(58) **Field of Classification Search** D9/755, D9/732, 499, 456, 455, 453, 452, 432, 431, D9/429, 428, 425, 424, 418, 414; D7/672, D7/641, 629, 610, 608, 602, 601, 587, 584, D7/542; D3/272, 269; 426/114, 106; 229/906, 229/904, 903, 902, 407, 406; 220/DIG. 12, 220/675, 672, 670, 669, 574, 556, 4.26, 306, 220/557, 508, 203, 783

See application file for complete search history.

(56) **References Cited**

U.S. PATENT DOCUMENTS

4,741,452	A	*	5/1988	Holzkopf	220/783
D298,791	S	*	12/1988	Holzkopf	D7/542
5,300,748	A	*	4/1994	Colombo	229/903
D392,881	S	*	3/1998	Bulcher et al.	D9/425
6,349,847	B1	*	2/2002	Mangla et al.	220/783
D461,123	S	*	8/2002	Hayes et al.	D9/429
D470,048	S	*	2/2003	Buchalski et al.	D9/425
D482,280	S	*	11/2003	Pratte	D9/434
D485,755	S	*	1/2004	Isler et al.	D9/425

* cited by examiner

Primary Examiner—Robert M. Spear
Assistant Examiner—Susan Bennett Hattan

1 Claim, 24 Drawing Sheets

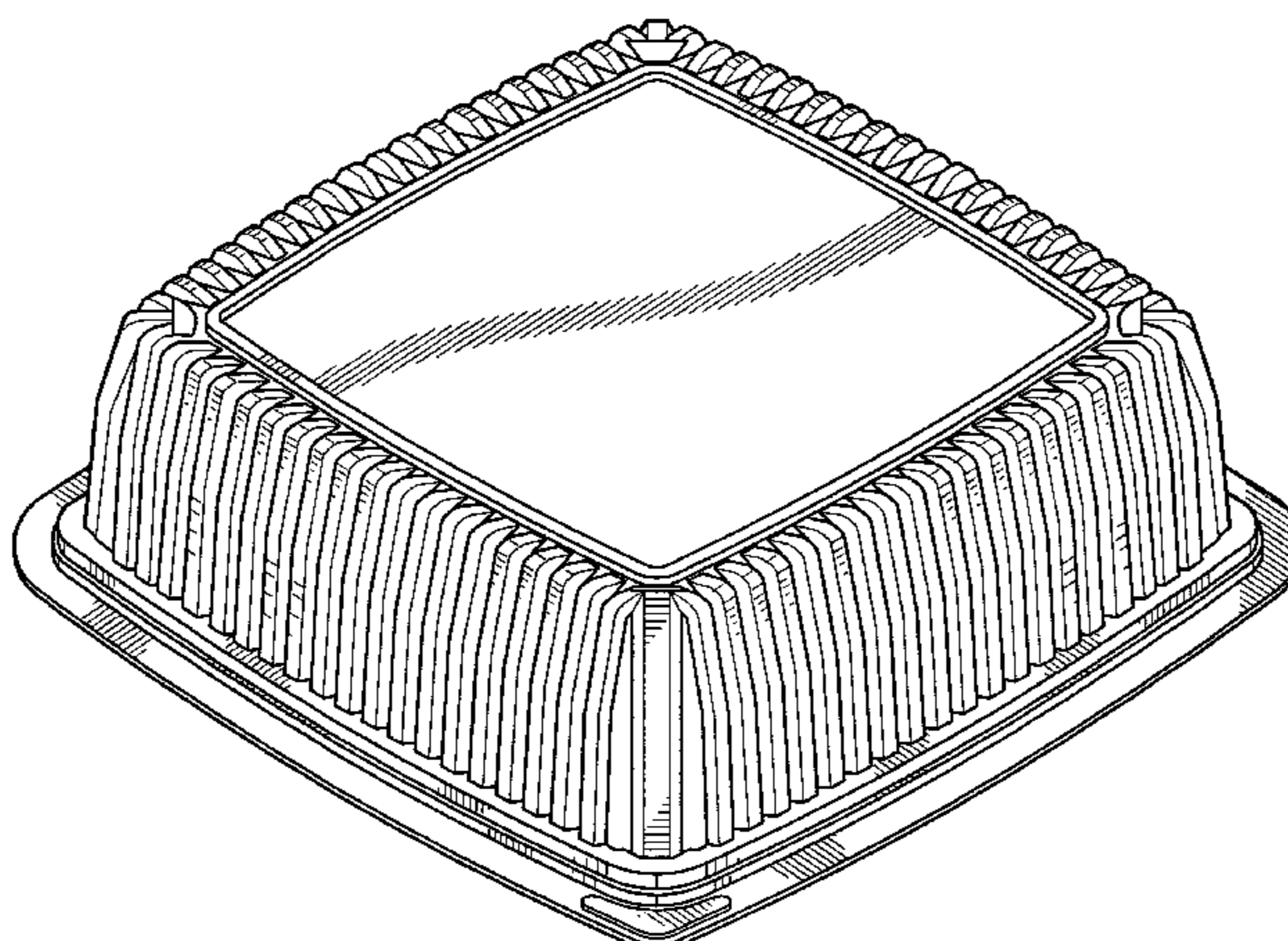

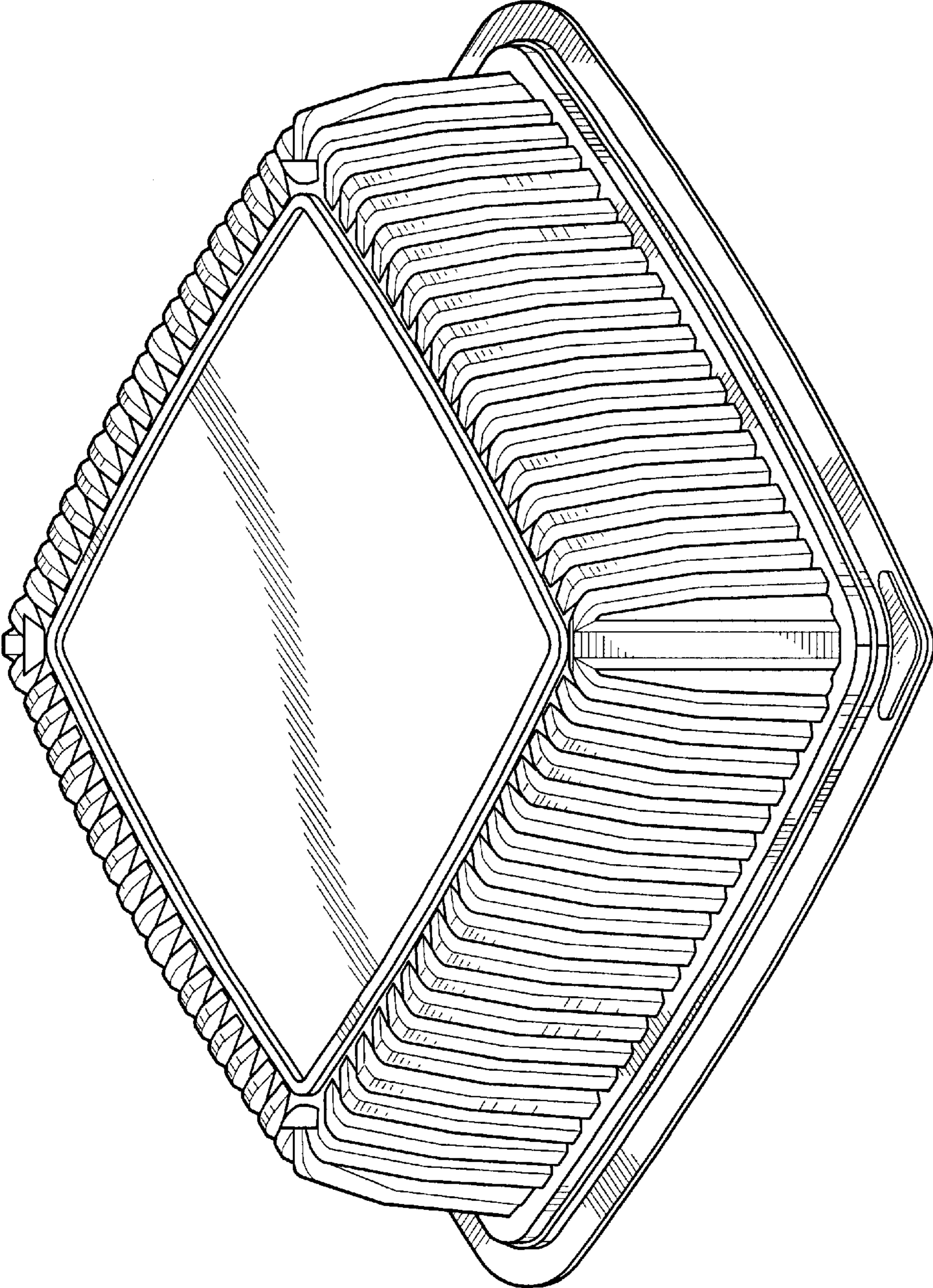

FIG. 1

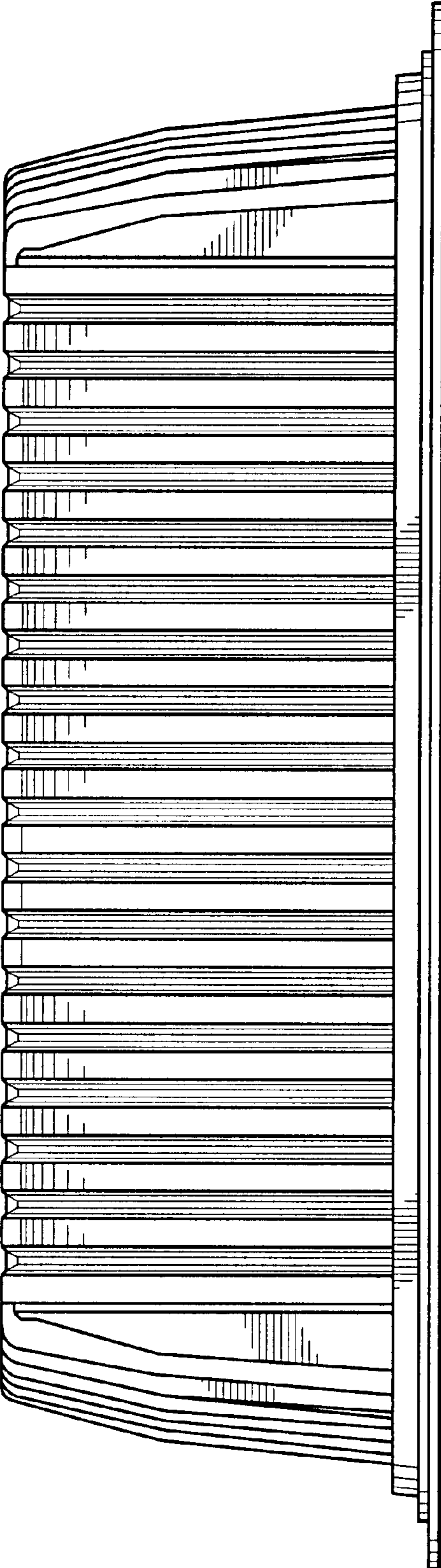

FIG. 2

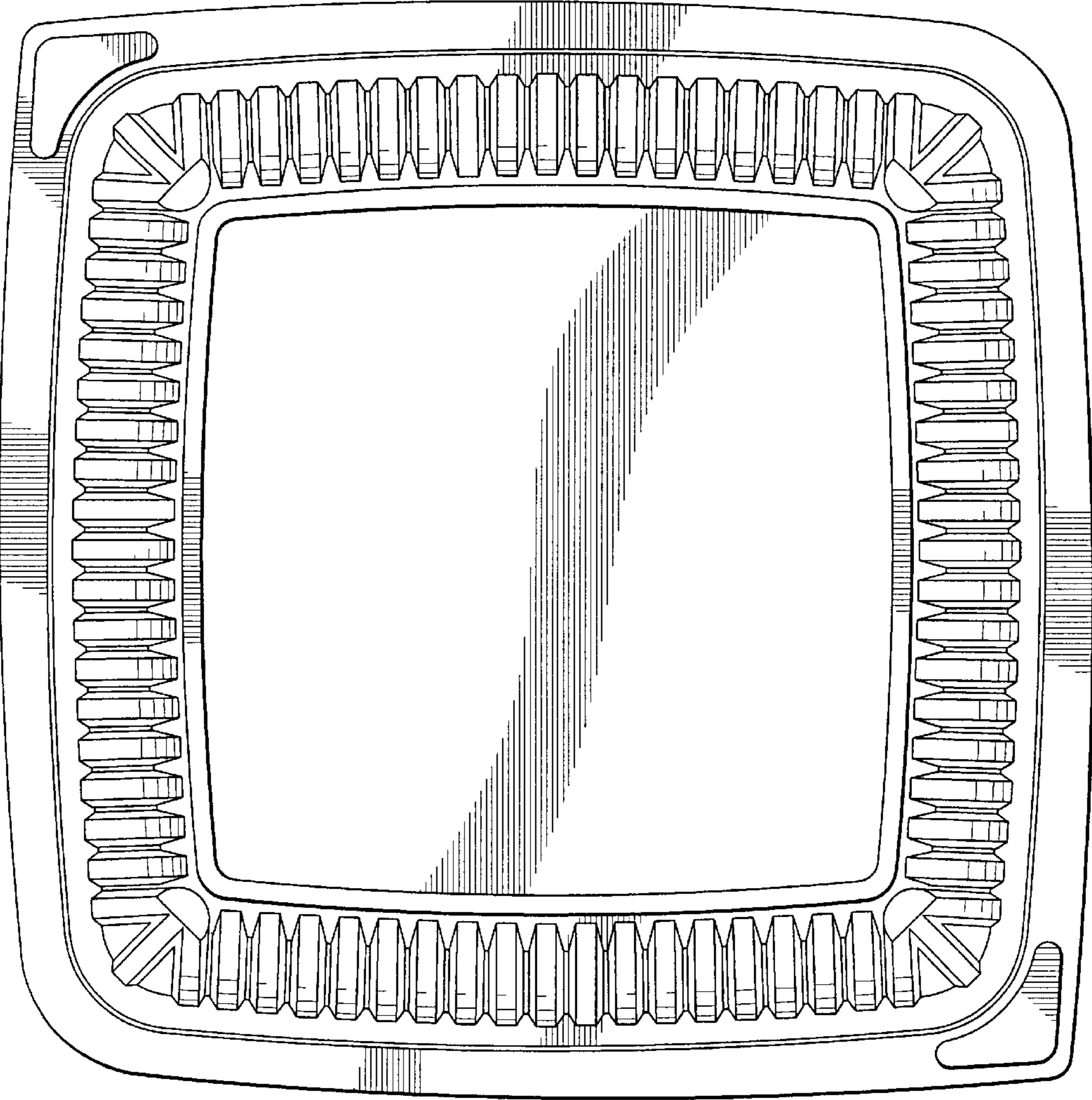

FIG. 3

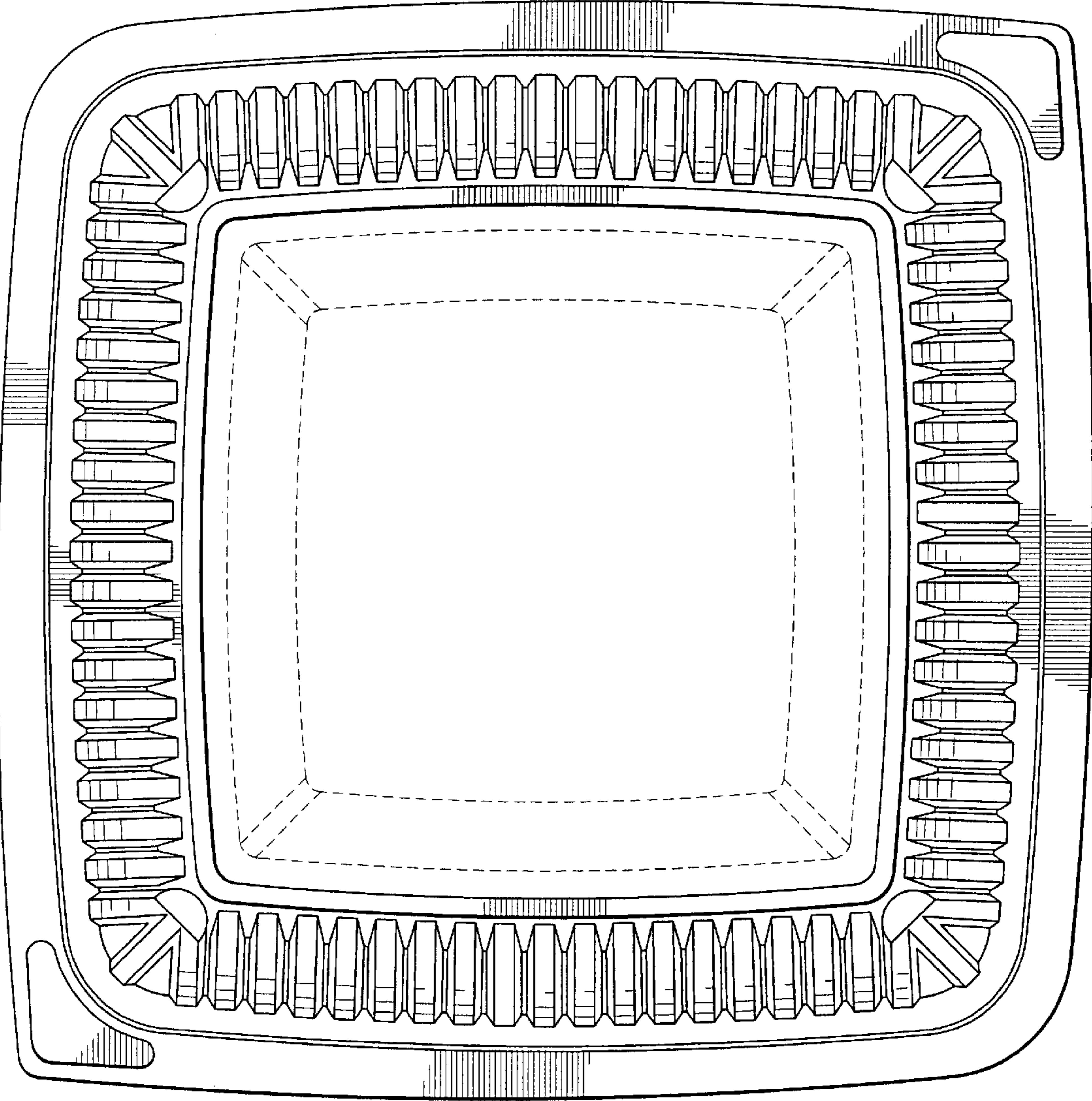

FIG.4

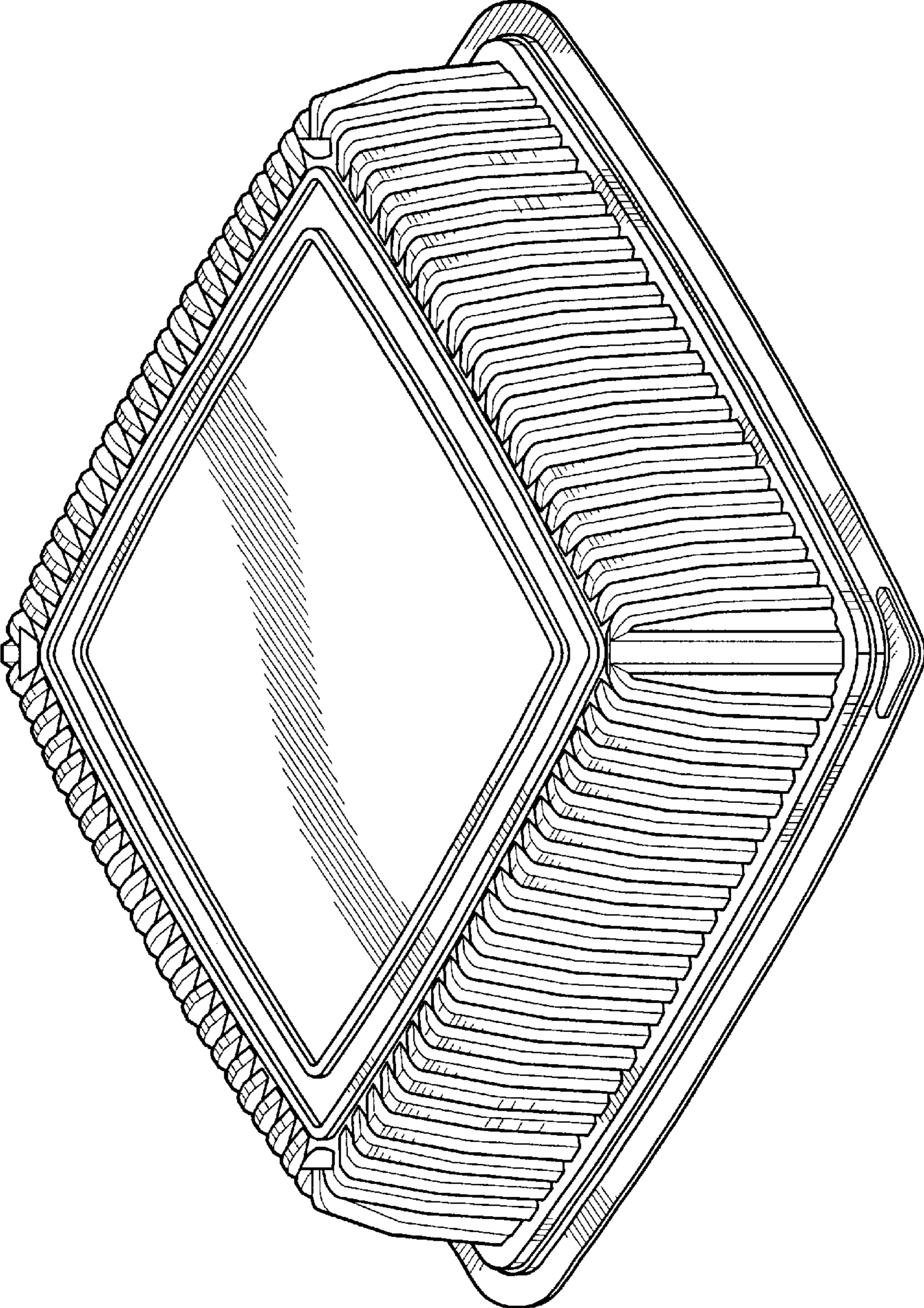

FIG. 5

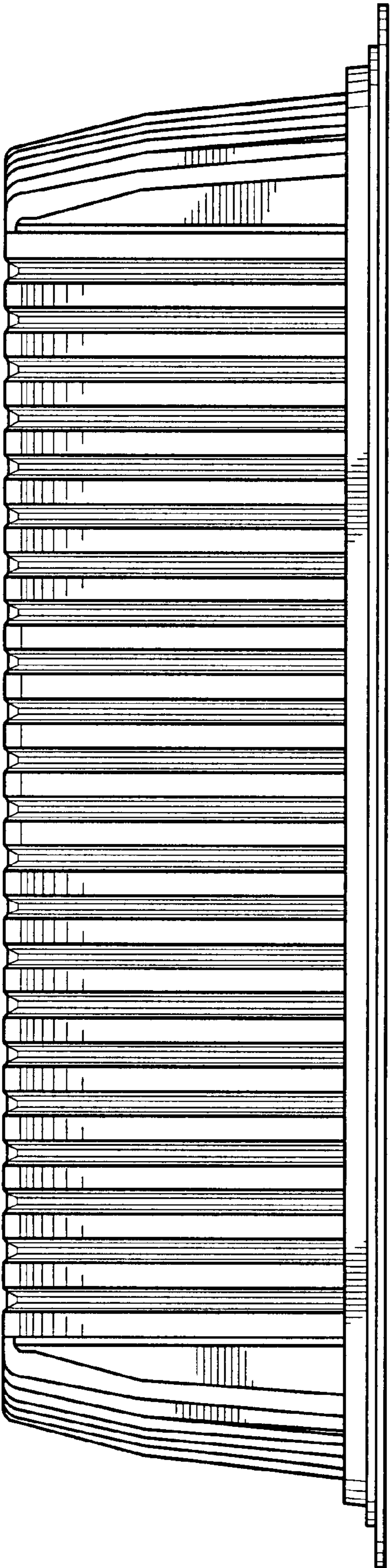

FIG. 6

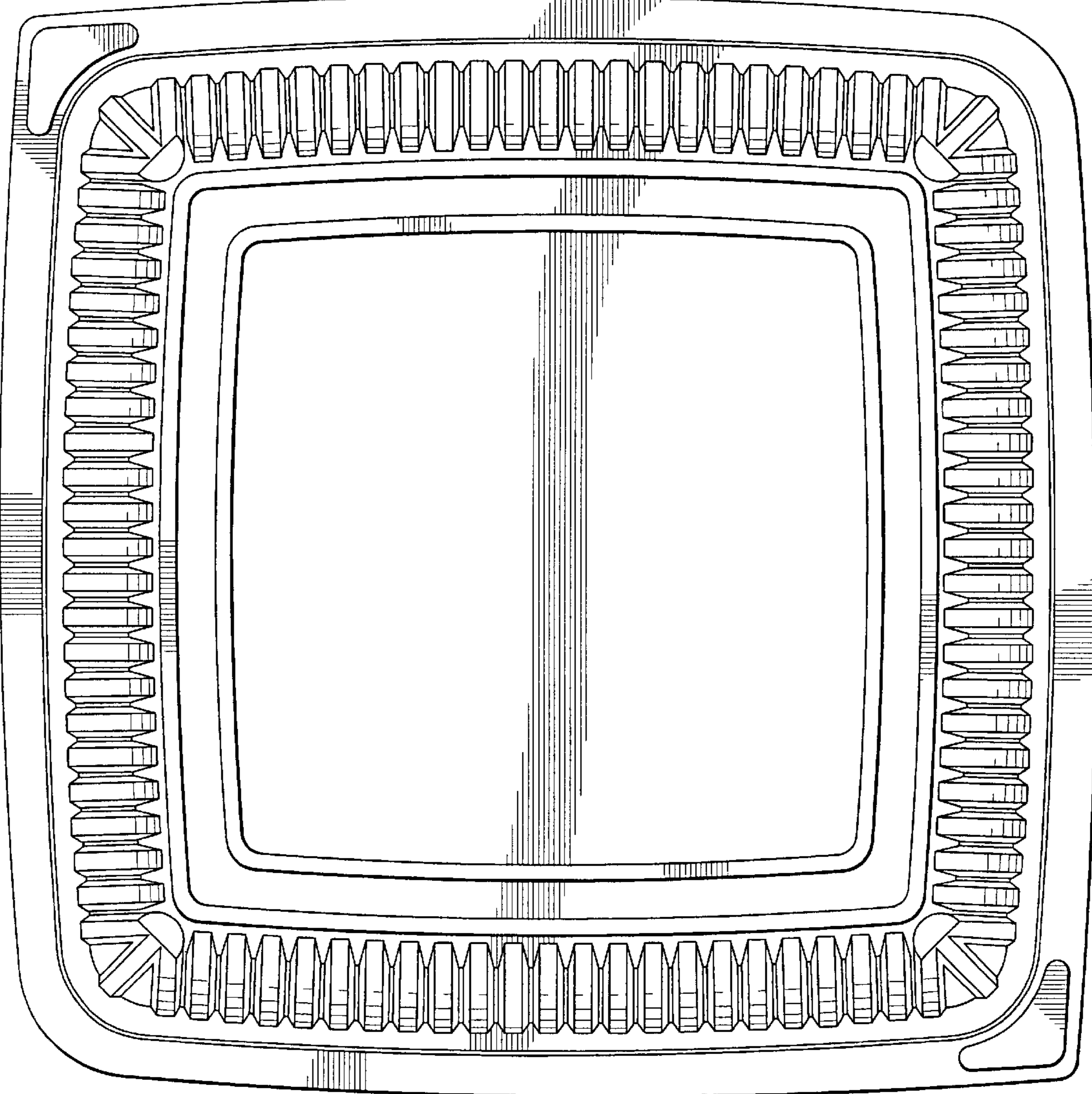

FIG. 7

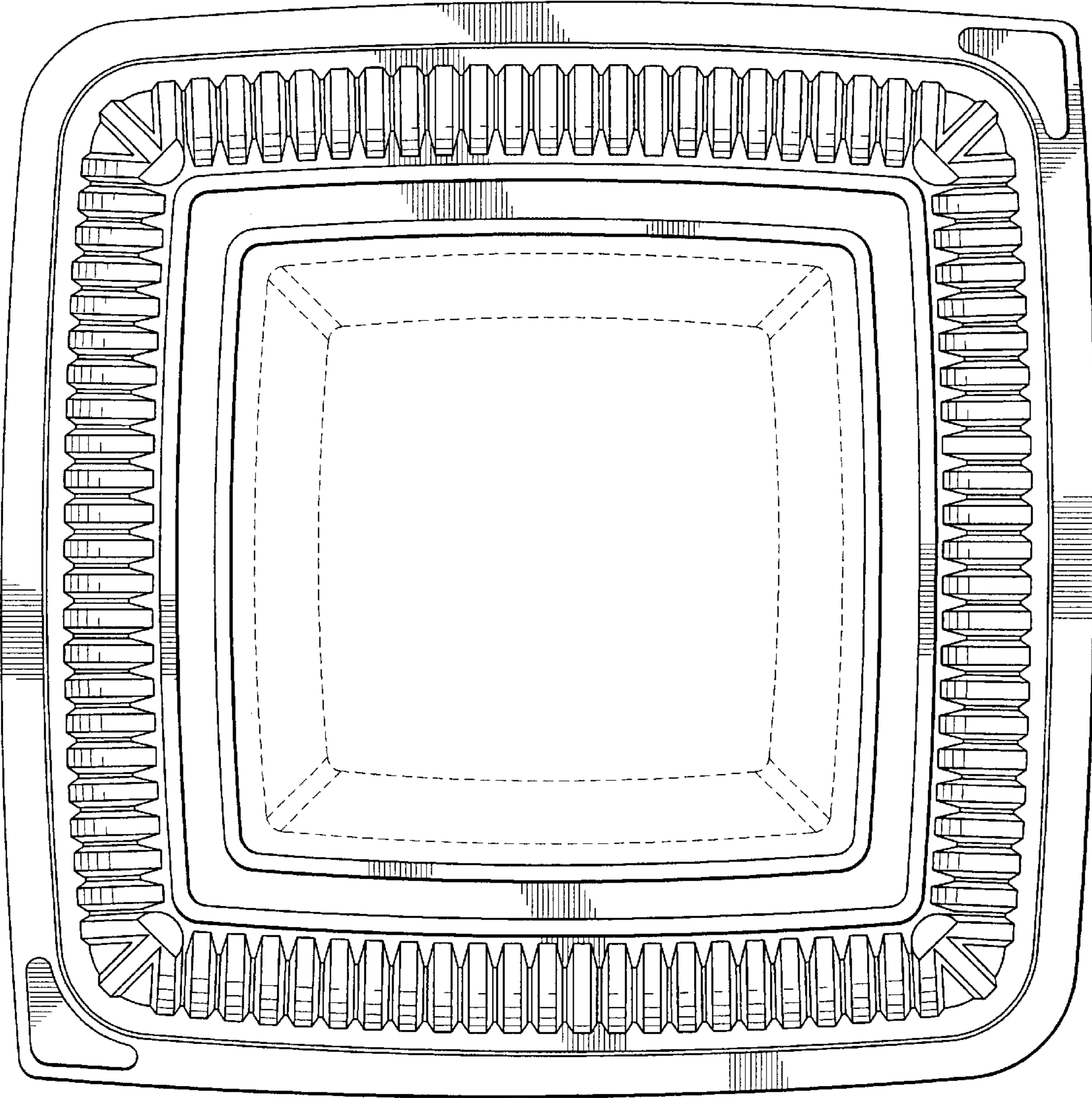

FIG. 8

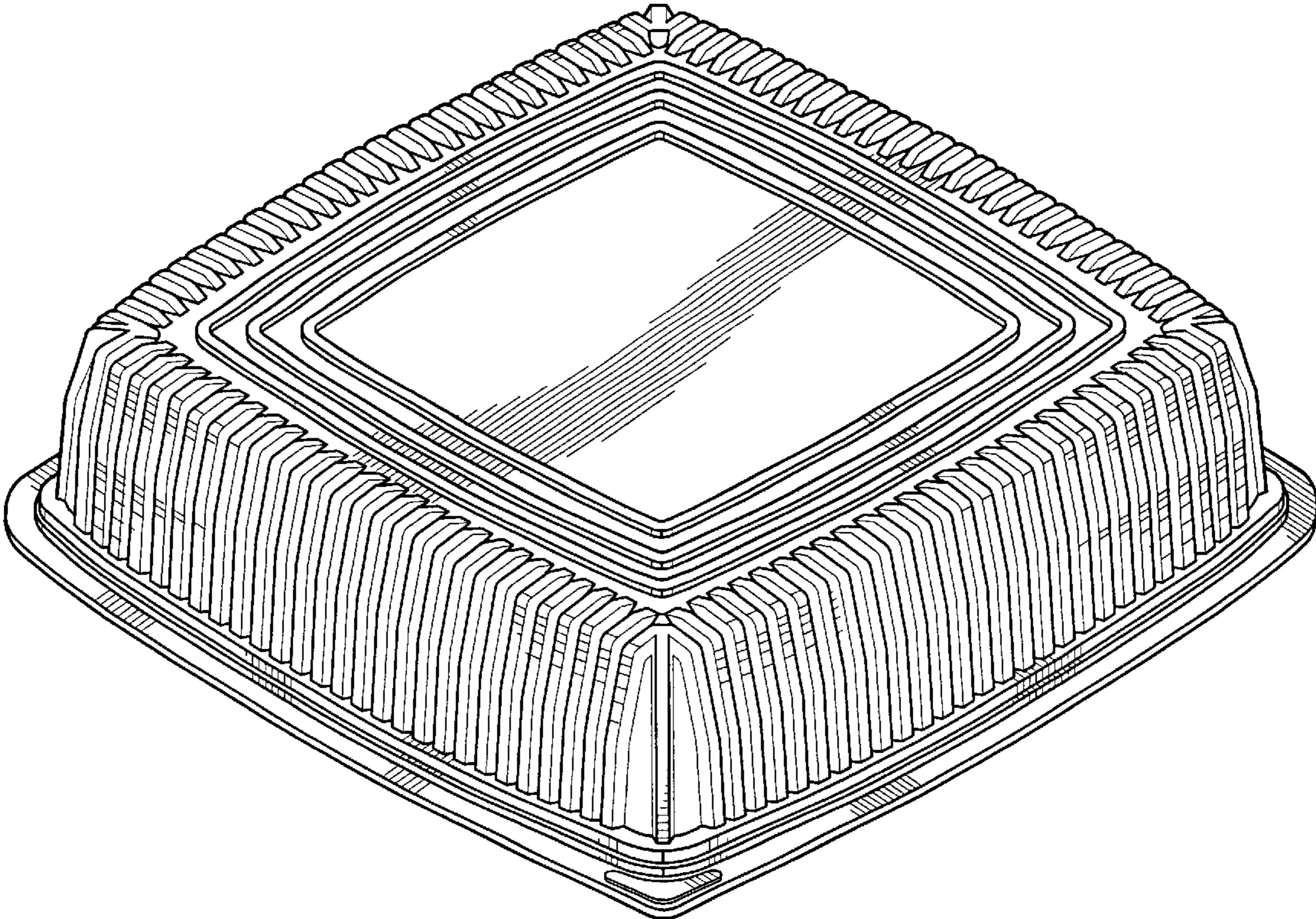

FIG. 9

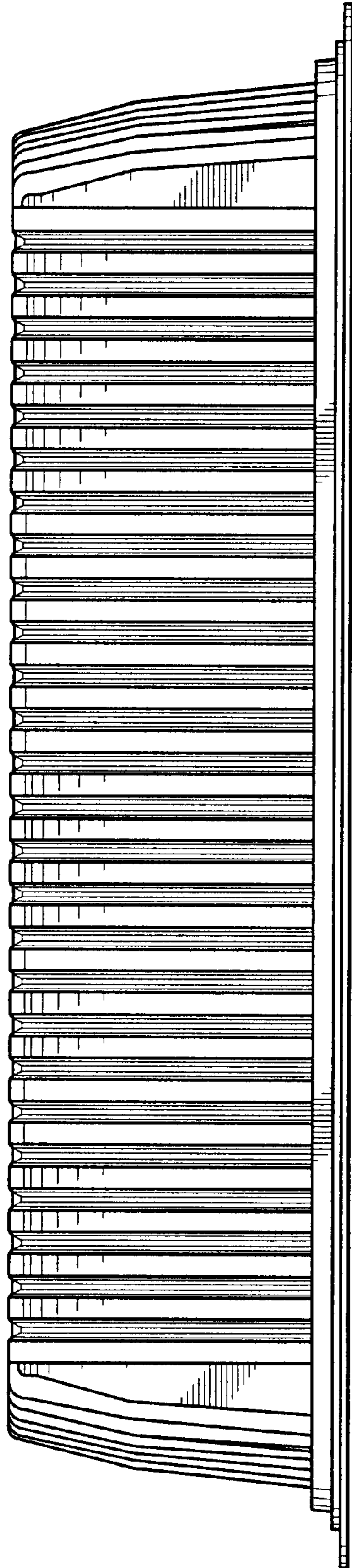

FIG. 10

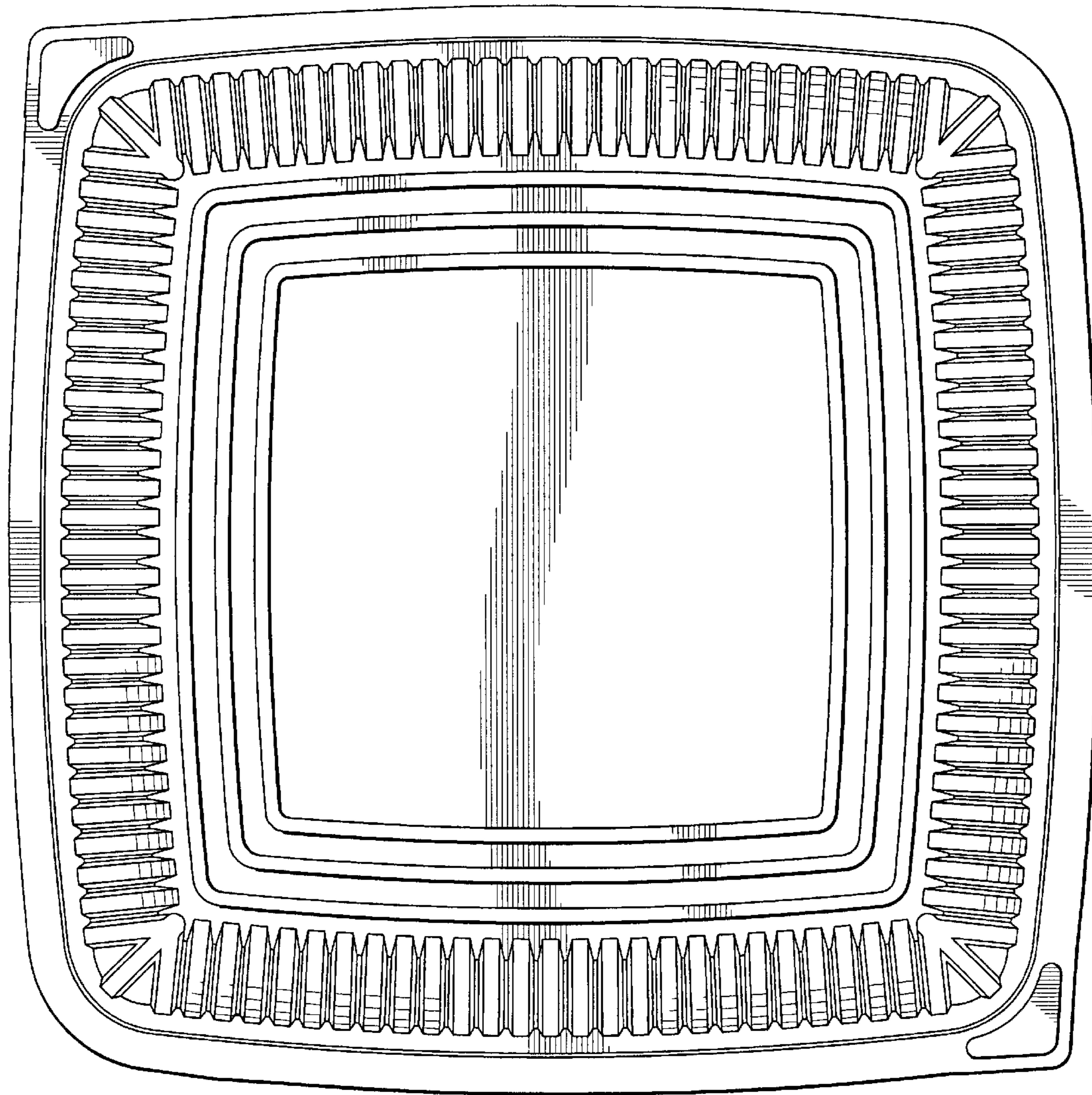

FIG. 11

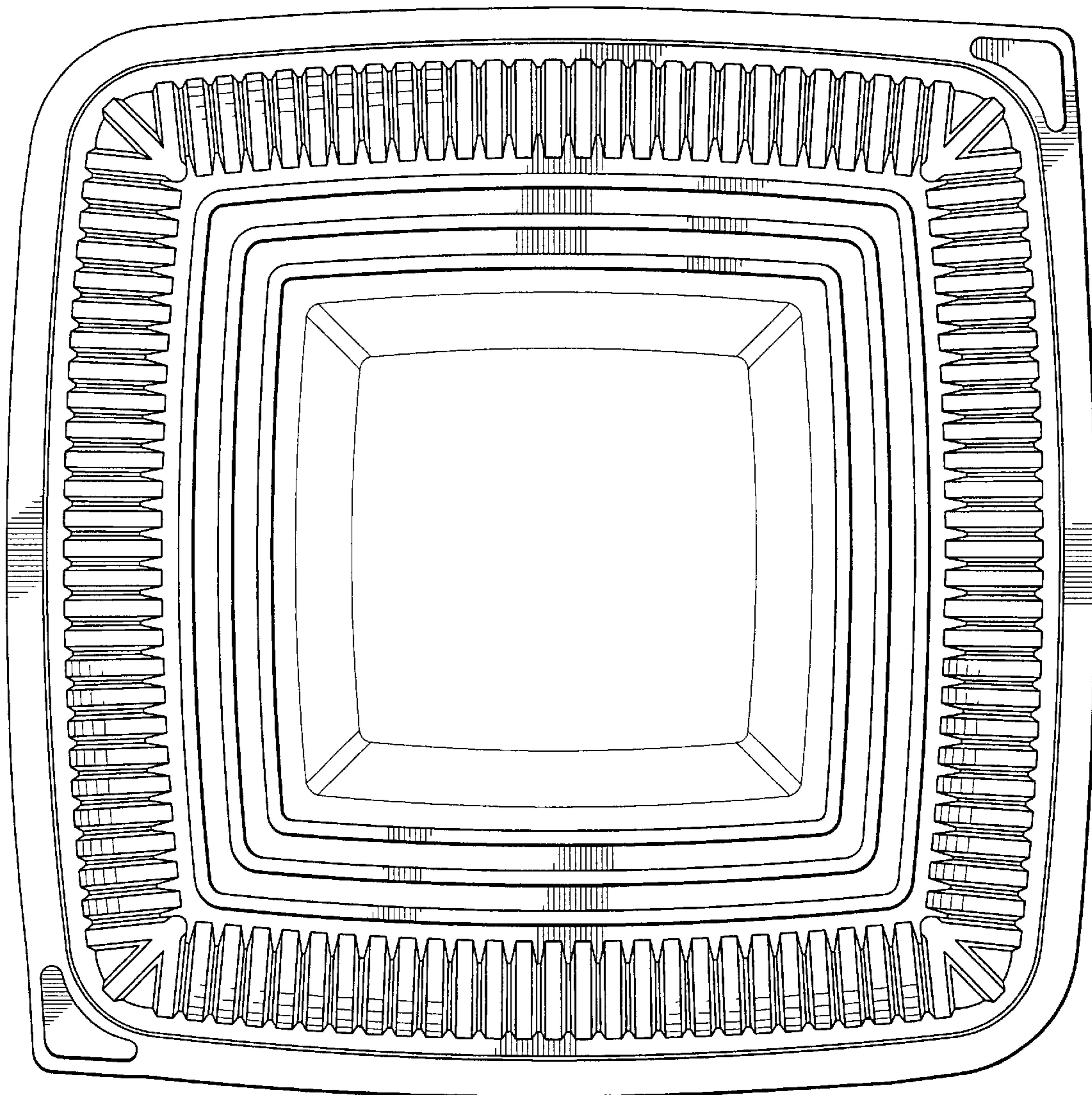

FIG. 12

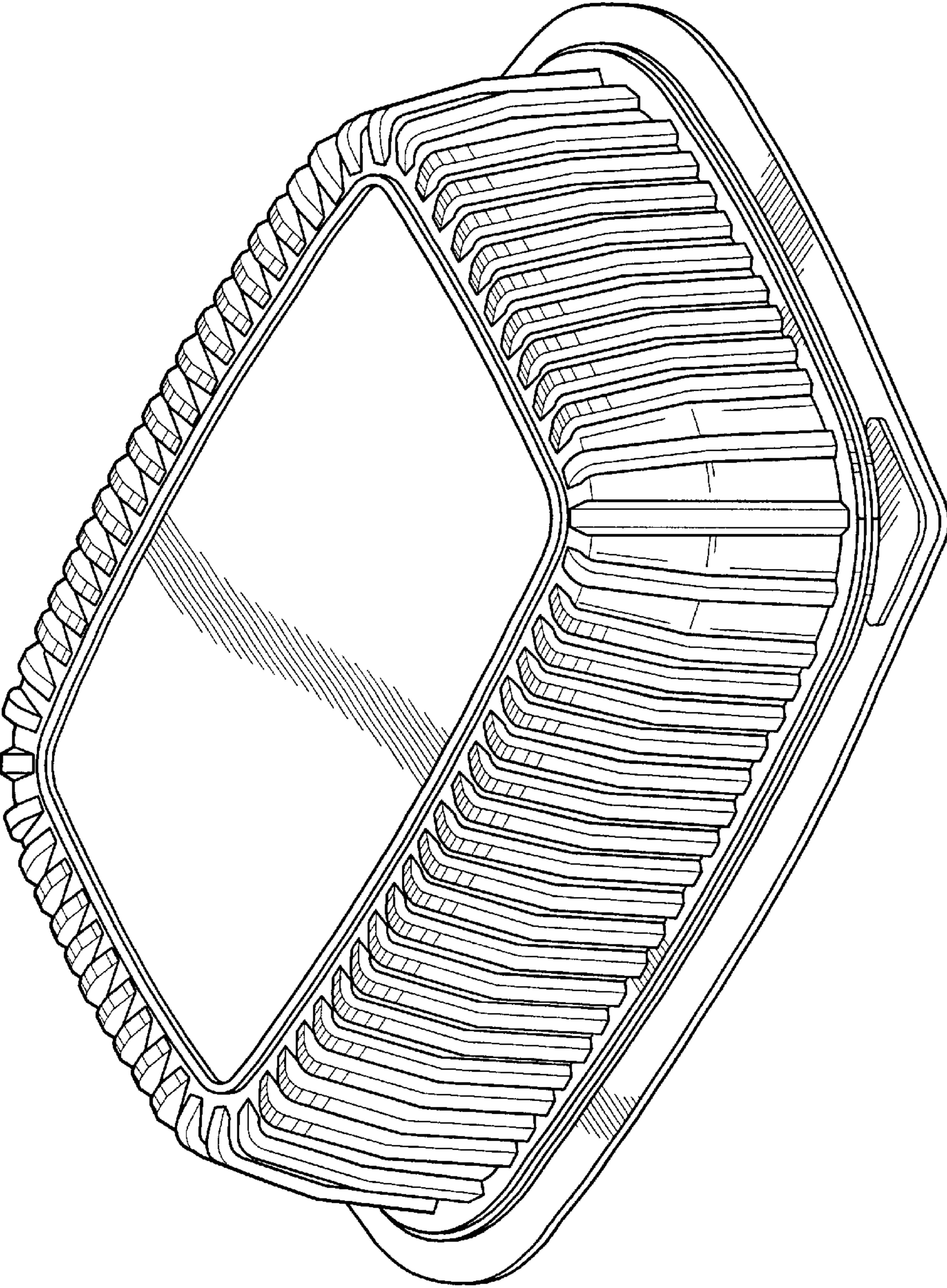

FIG.13

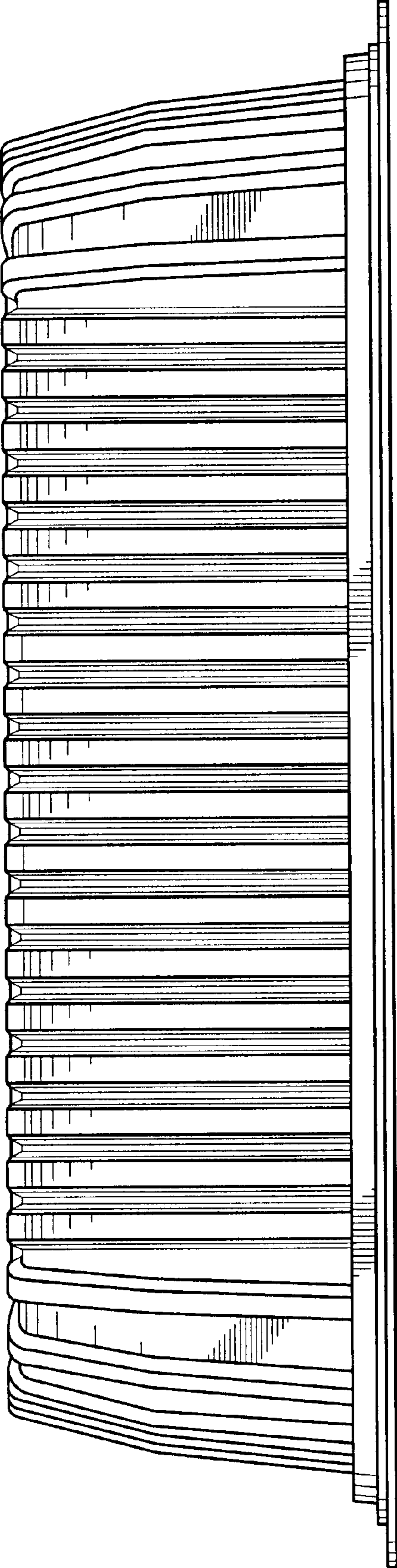

FIG. 14

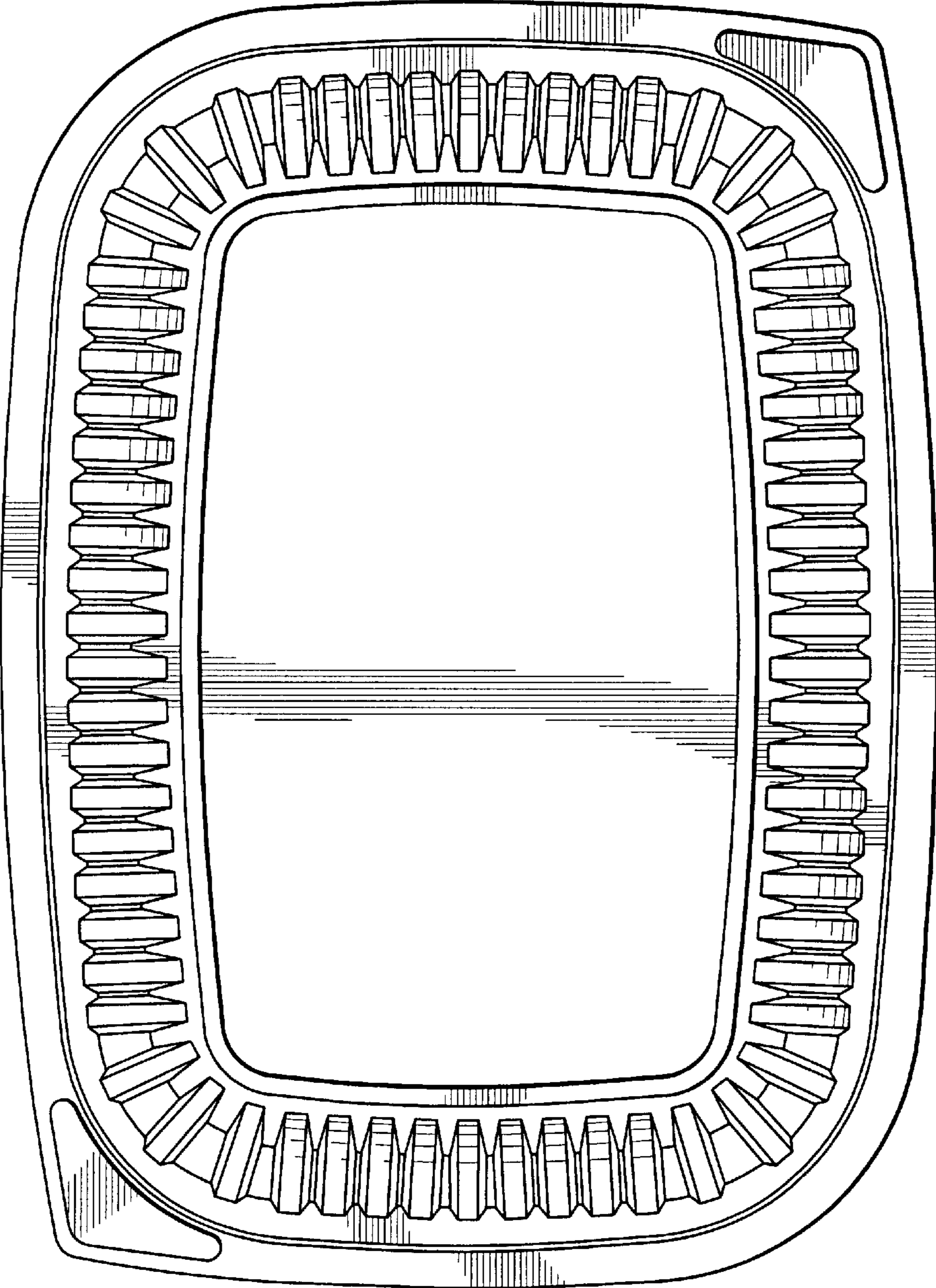

FIG.15

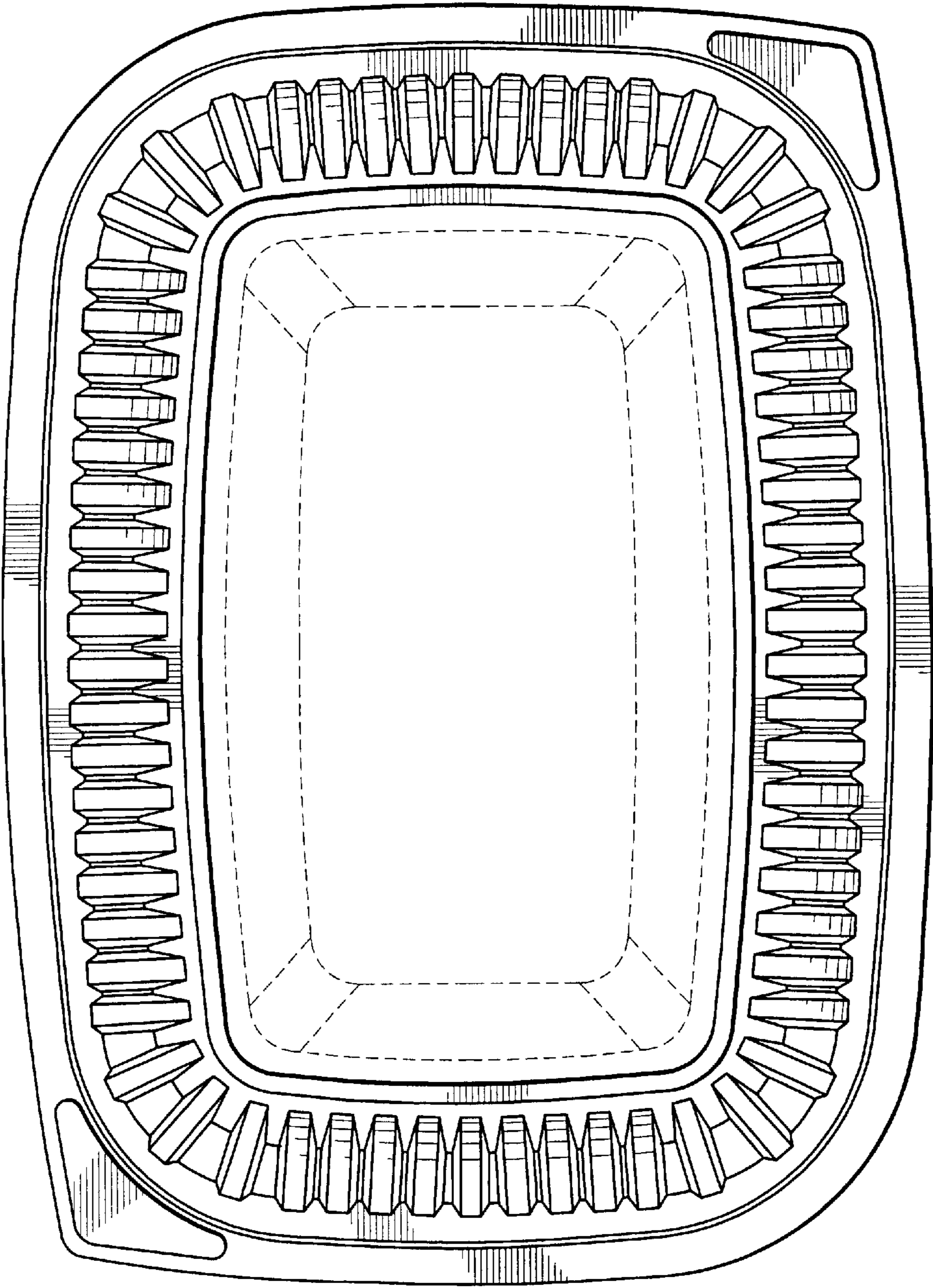

FIG. 16

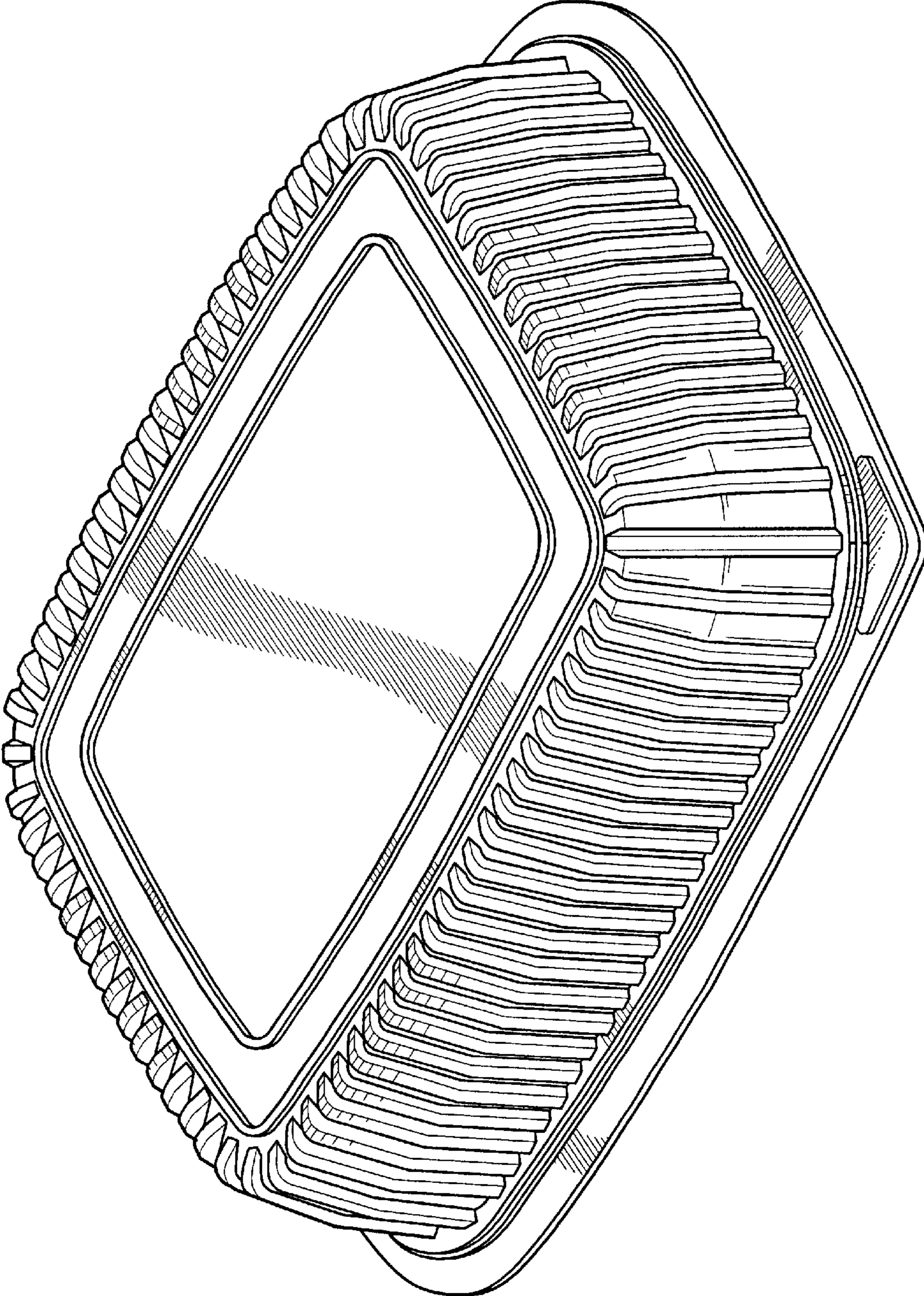

FIG.17

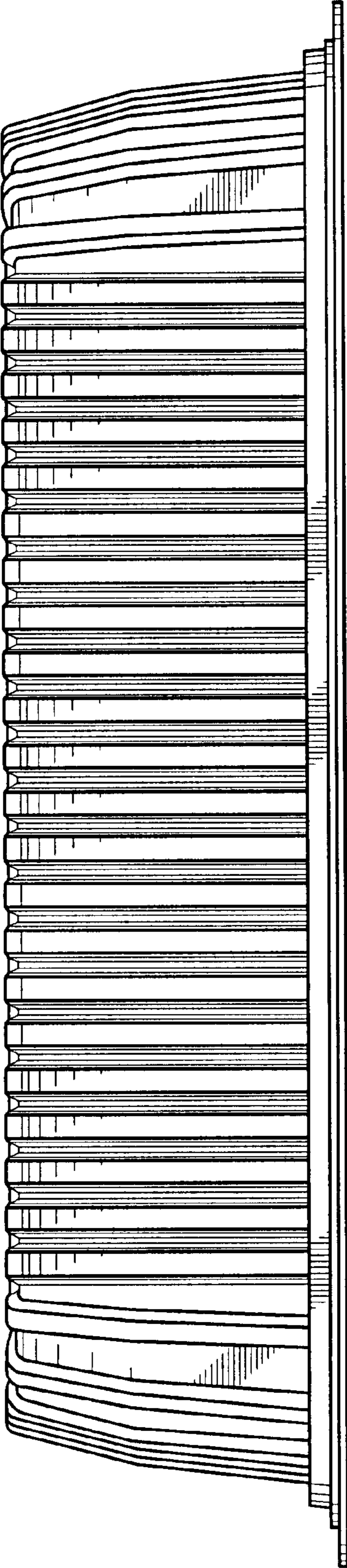

FIG. 18

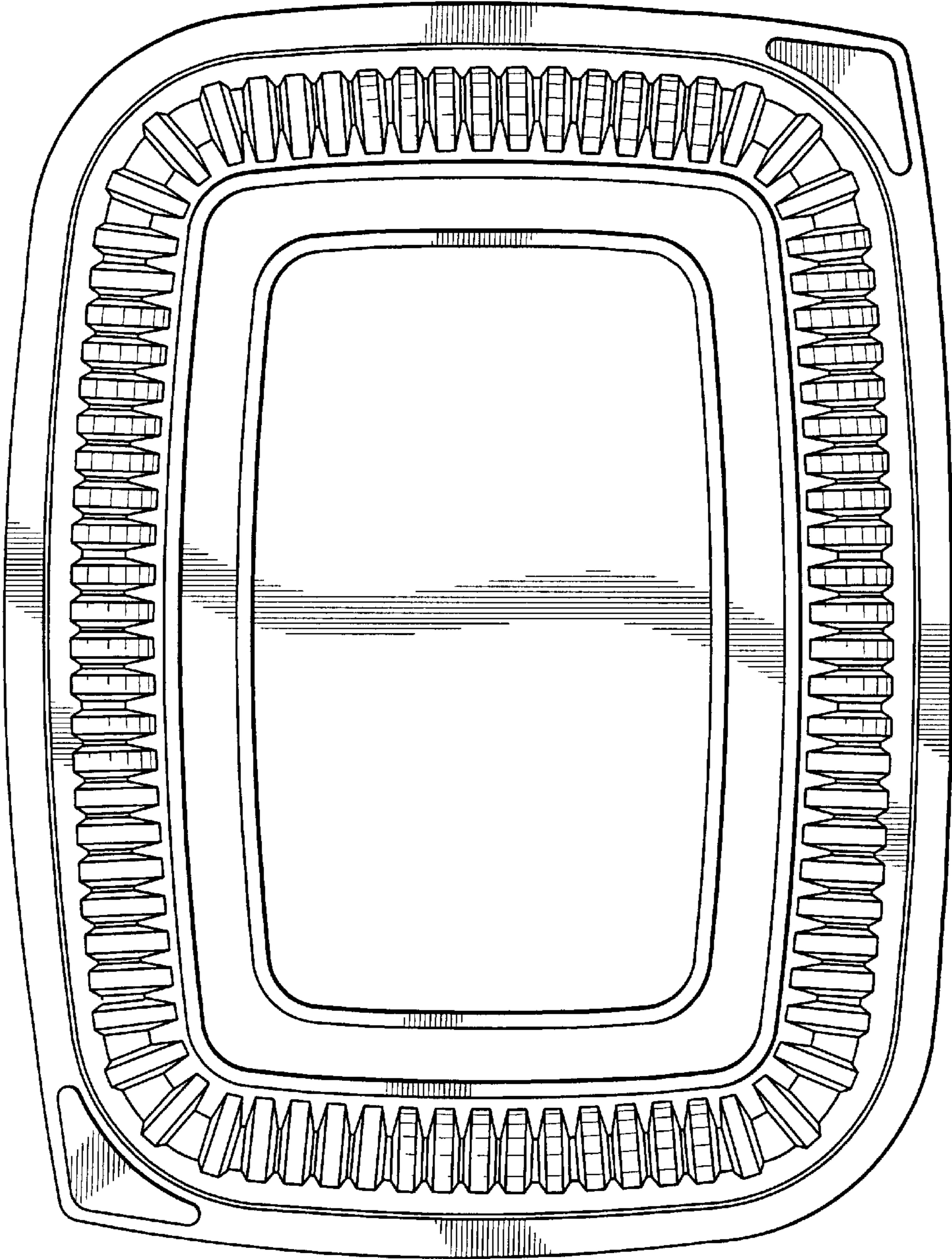

FIG. 19

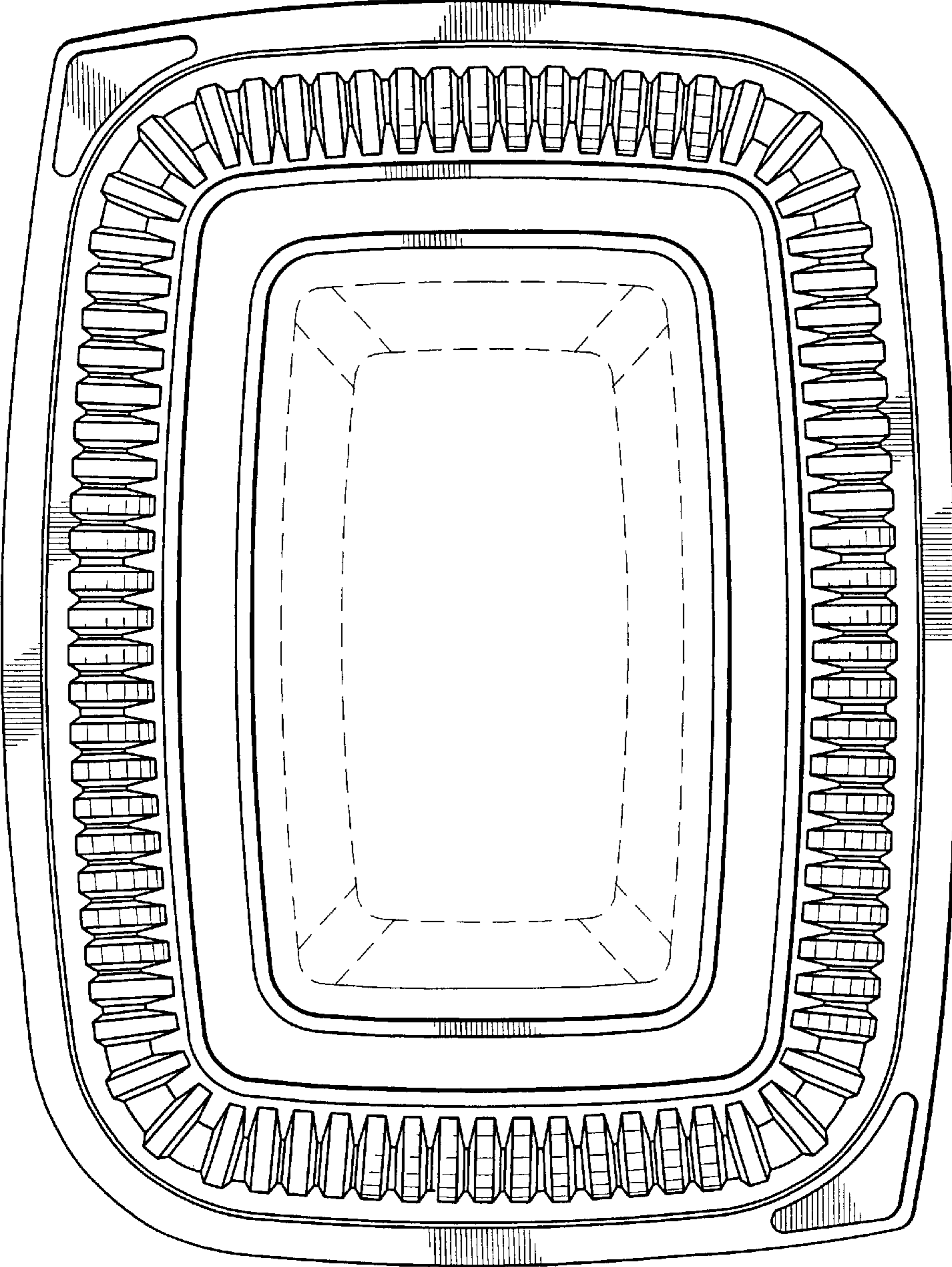

FIG. 20

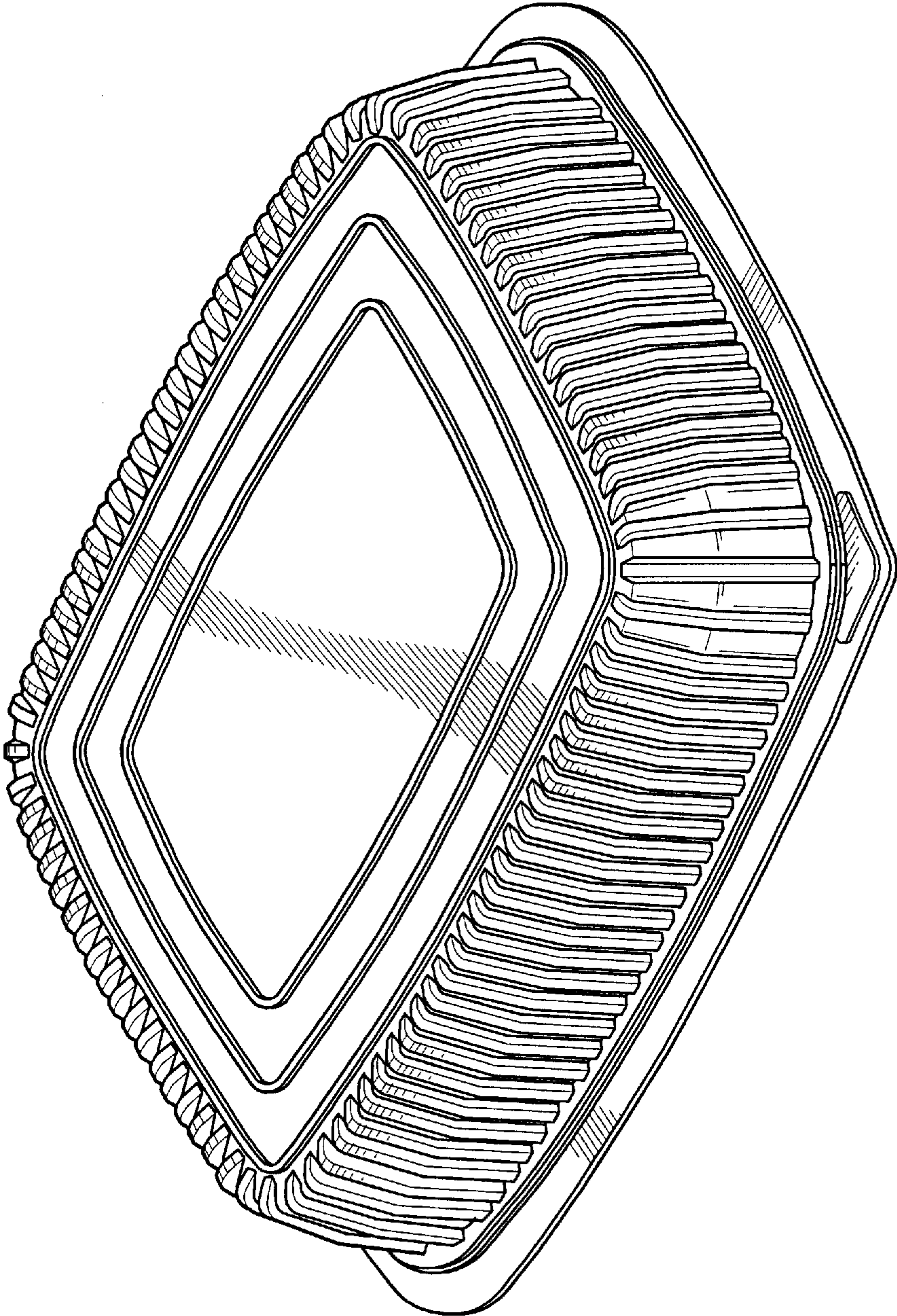

FIG. 21

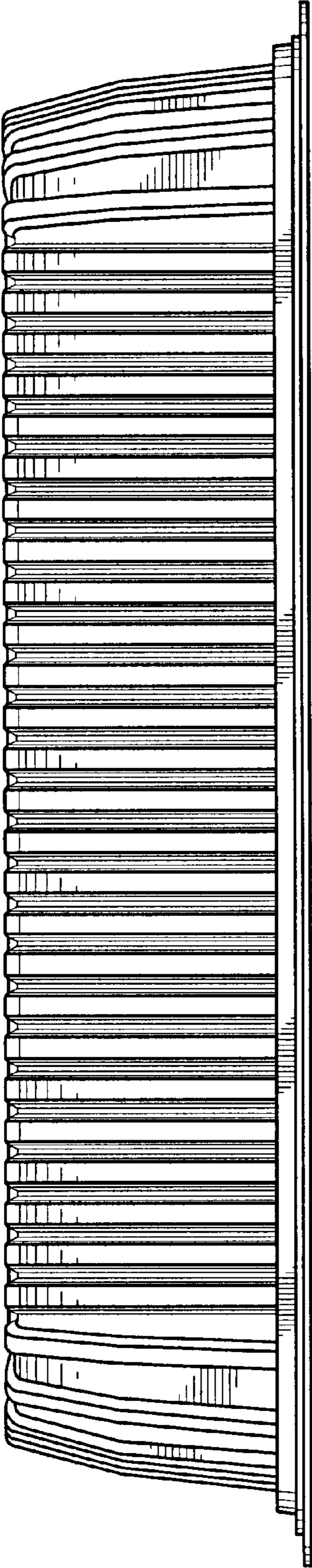

FIG. 22

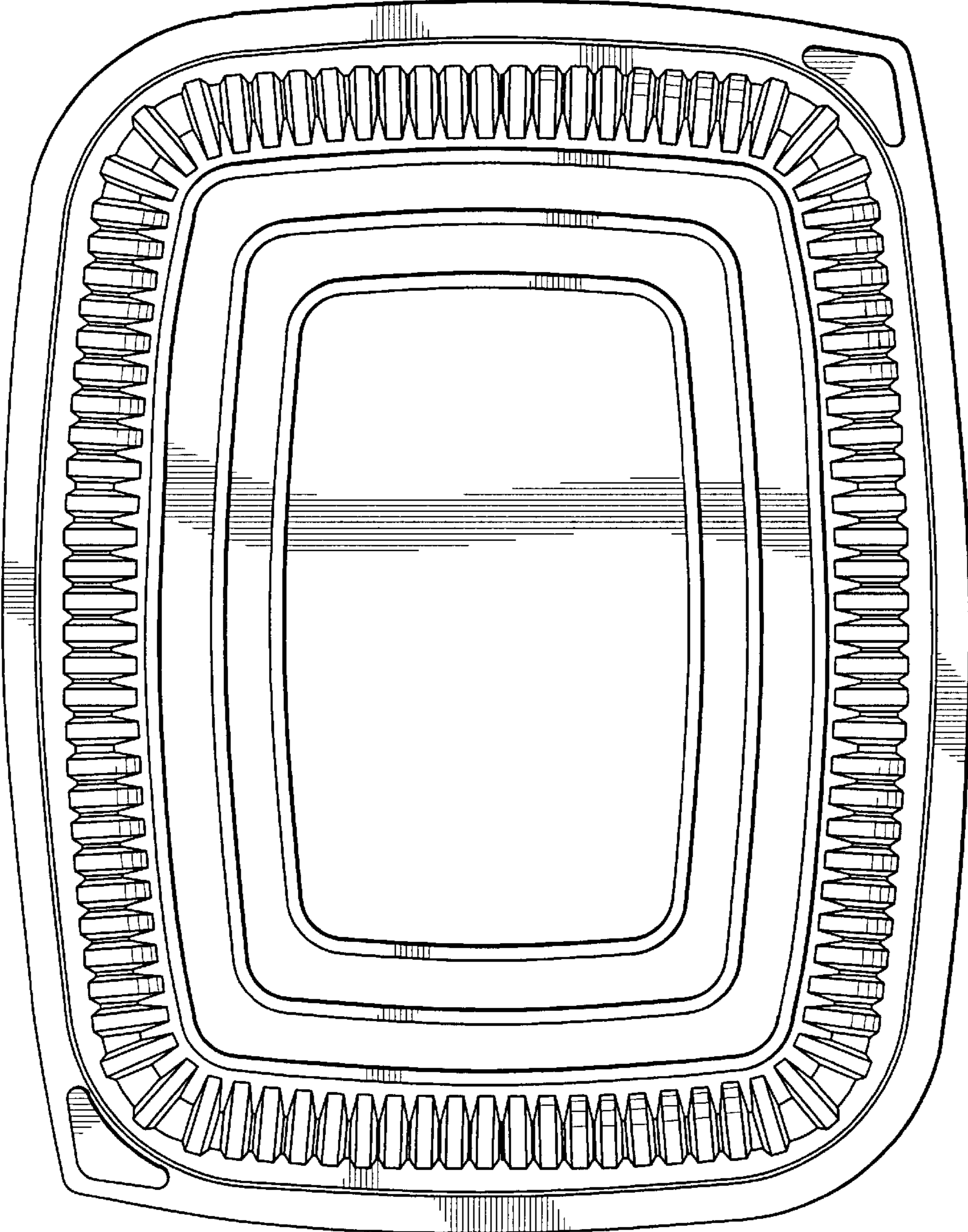

FIG. 23

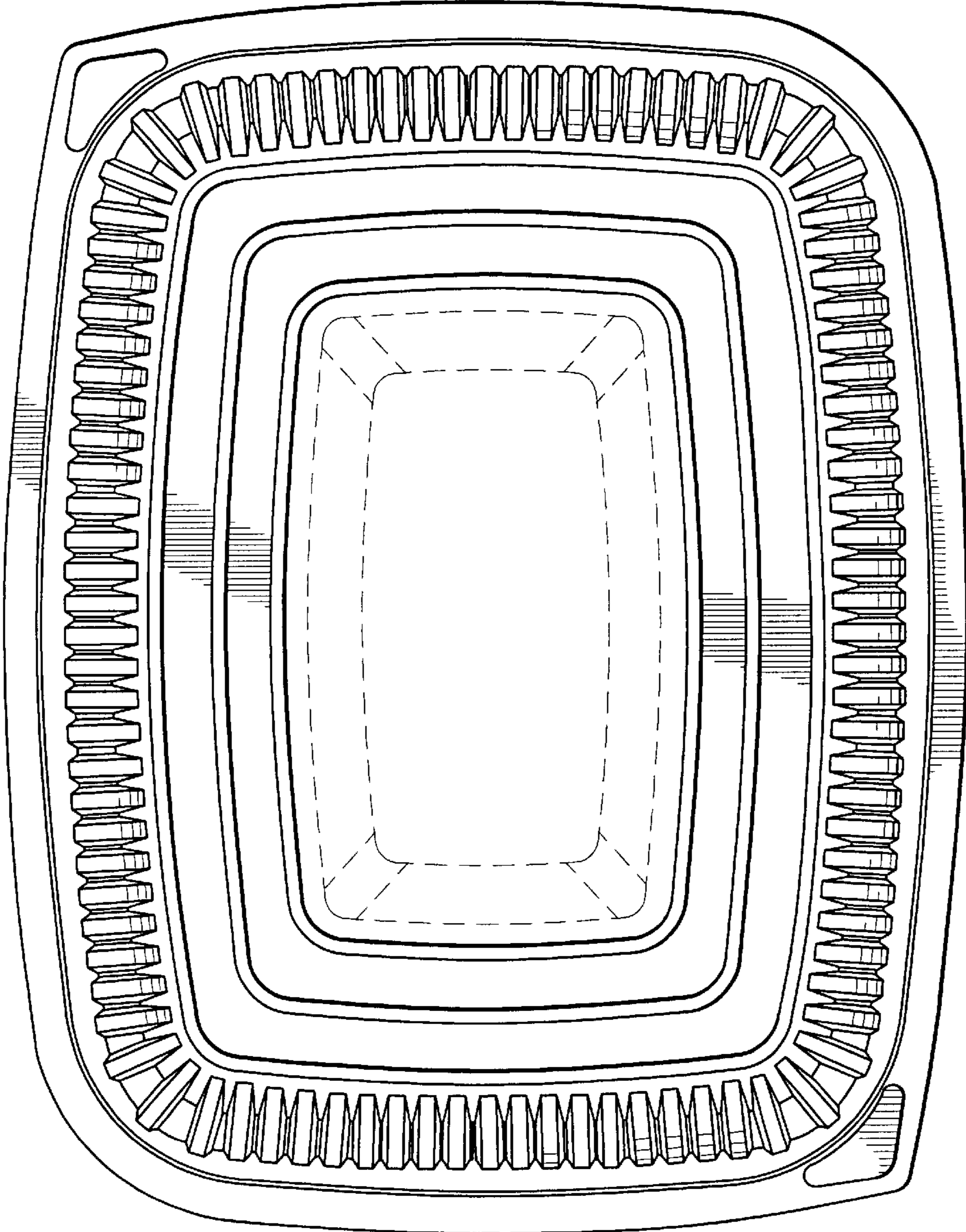

FIG. 24