



US00D513352S

(12) **United States Design Patent**
Weathers et al.

(10) **Patent No.:** **US D513,352 S**

(45) **Date of Patent:** **** Dec. 27, 2005**

(54) **LEAF CHUTE**

(76) Inventors: **Larry Vernon Weathers**, 4850 Park Pl.
East, North Charleston, SC (US) 29405;
Linda Howell Weathers, 4850 Park Pl.
East, North Charleston, SC (US) 29405

(**) **Term:** **14 Years**

(21) **Appl. No.:** **29/198,830**

(22) **Filed:** **Feb. 5, 2004**

(51) **LOC (6) Cl.** **09-09**

(52) **U.S. Cl.** **D34/5**

(58) **Field of Search** D34/1, 4, 5, 6;
248/95, 96, 97, 100, 101, 157, 175

(56) **References Cited**

U.S. PATENT DOCUMENTS

D219,305 S	*	11/1970	Mozneck	D34/1
D288,493 S	*	2/1987	Lopez	D34/1
4,760,982 A	*	8/1988	Cooke	248/99
D304,872 S	*	11/1989	Jebb	D34/1
4,892,223 A	*	1/1990	DeMent	229/117.35
D308,270 S	*	5/1990	Sarabia	D34/5
D309,966 S	*	8/1990	Bishop	D34/5
5,205,107 A	*	4/1993	Herink	53/255
D376,237 S	*	12/1996	Hayes et al.	D34/6
6,155,522 A	*	12/2000	Anderson	248/99

D440,729 S	*	4/2001	Piner et al.	D34/28
6,450,461 B1	*	9/2002	Lohmann	248/99
6,536,488 B1	*	3/2003	Pochobradsky	141/390
6,708,742 B2	*	3/2004	Weathers et al.	141/391
D499,075 S	*	11/2004	Yoon et al.	D13/180

* cited by examiner

Primary Examiner—Cynthia E. Ramirez

(74) *Attorney, Agent, or Firm*—Harleston Law Firm, LLC;
Kathleen M. Harleston

(57) **CLAIM**

The ornamental design for a leaf chute, as shown and described.

DESCRIPTION

FIG. 1 is a perspective view of a leaf chute, showing my new design in condition of use with a trash bag;

FIG. 2 is a top plan view thereof;

FIG. 3 is a bottom plan view thereof;

FIG. 4 is a left side elevational view thereof;

FIG. 5 is a right side elevational view thereof;

FIG. 6 is a front end elevational view thereof; and,

FIG. 7 is a rear end elevational view thereof.

The broken line showing of a paper trash bag in FIG. 1 is for illustrative purposes only and forms no part of the claimed design.

1 Claim, 4 Drawing Sheets

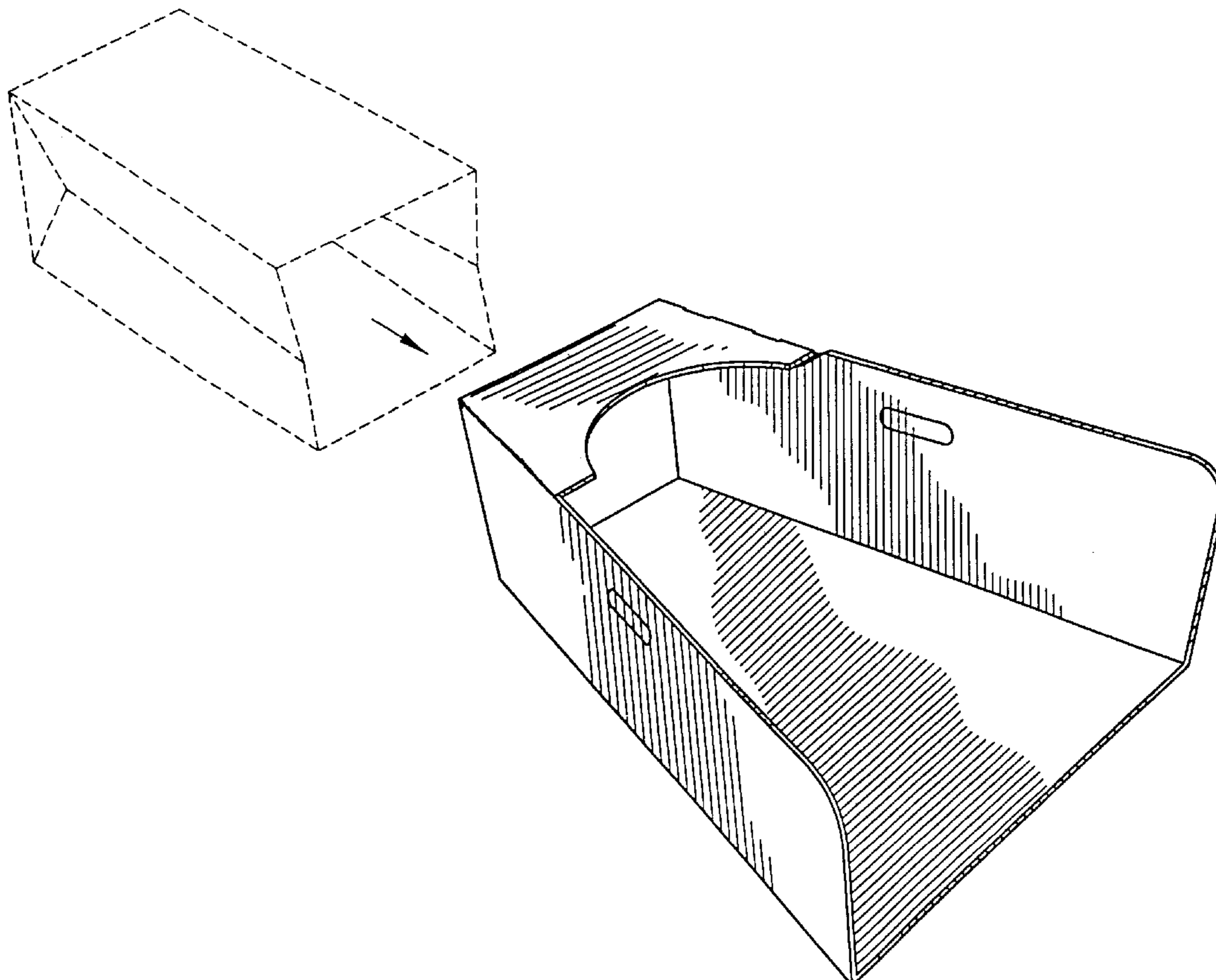

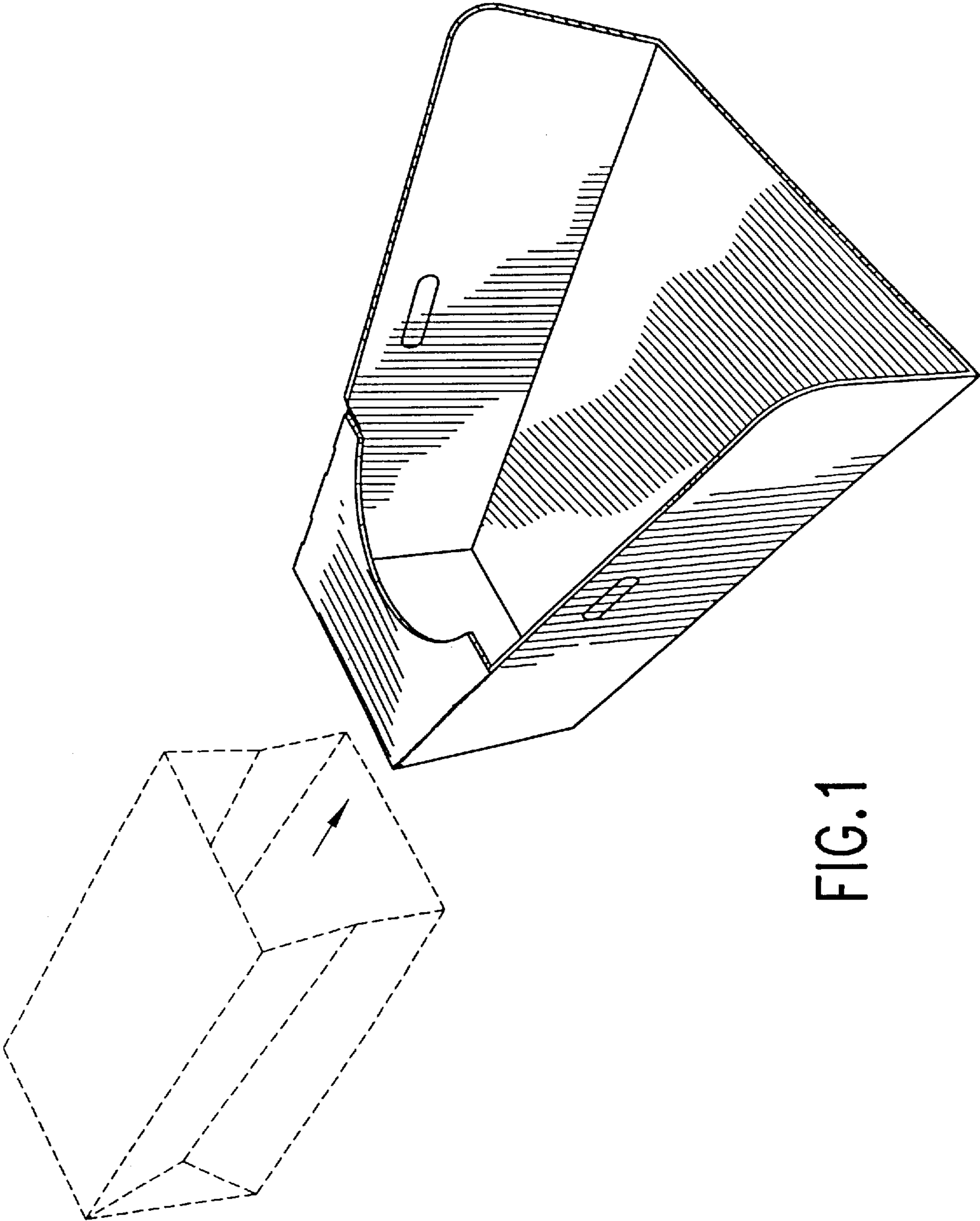

FIG. 1

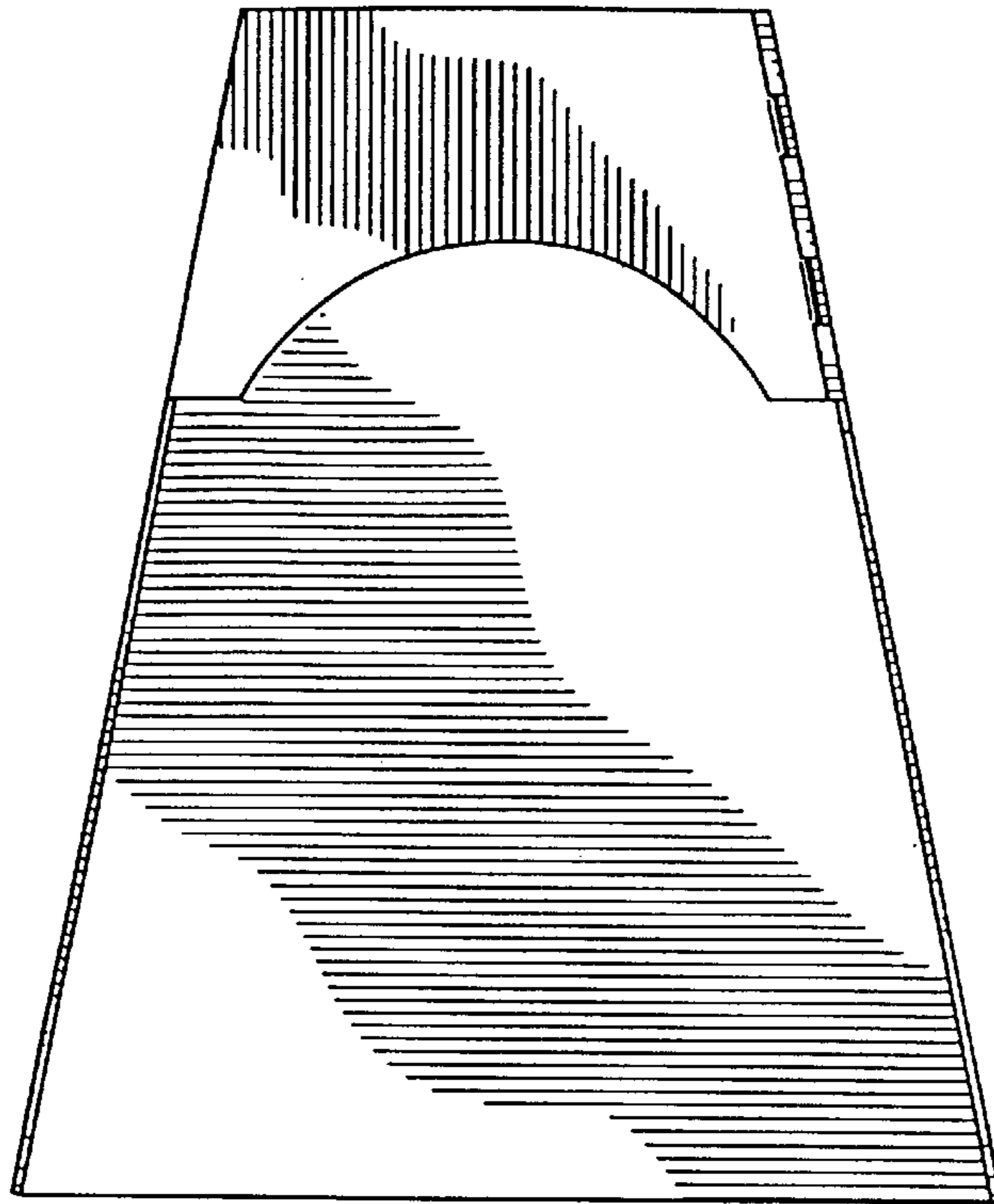

FIG. 2

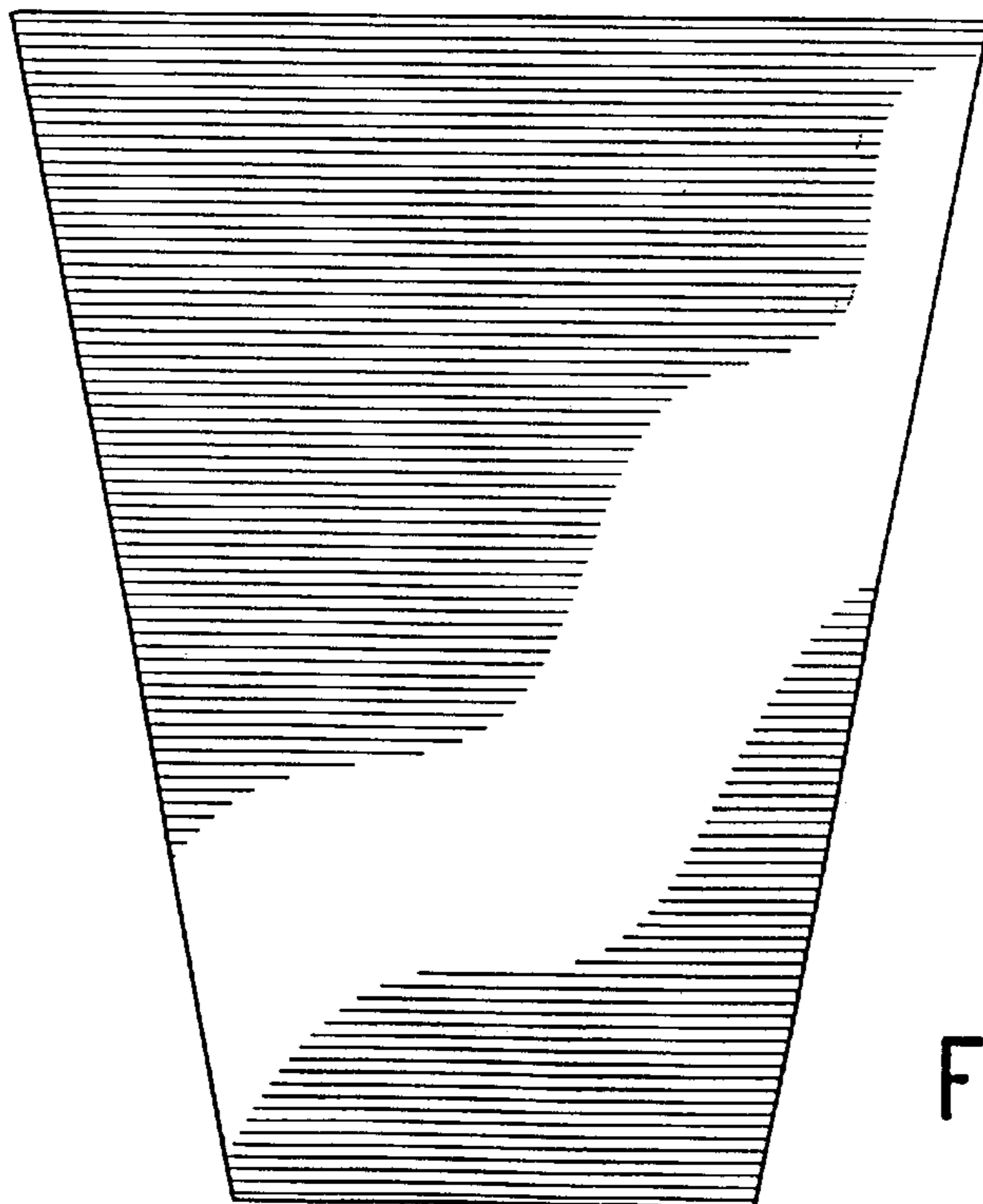

FIG. 3

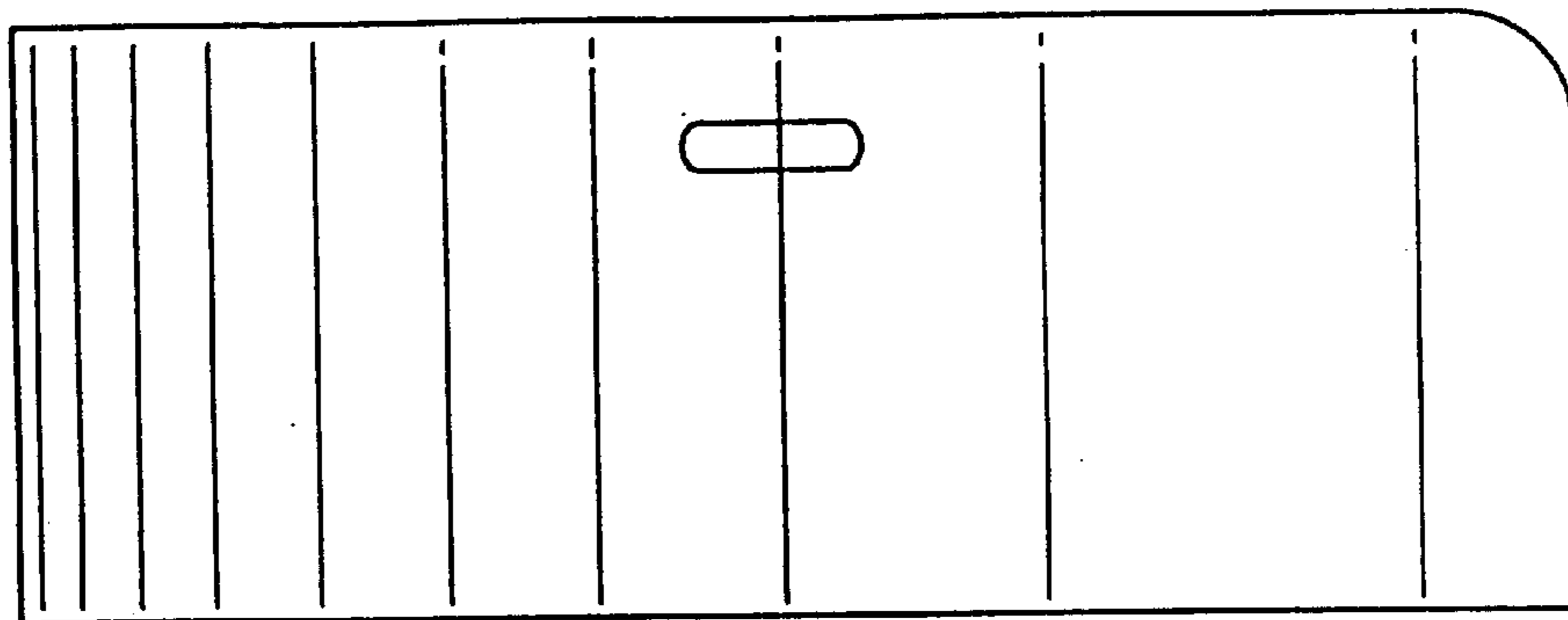

FIG. 4

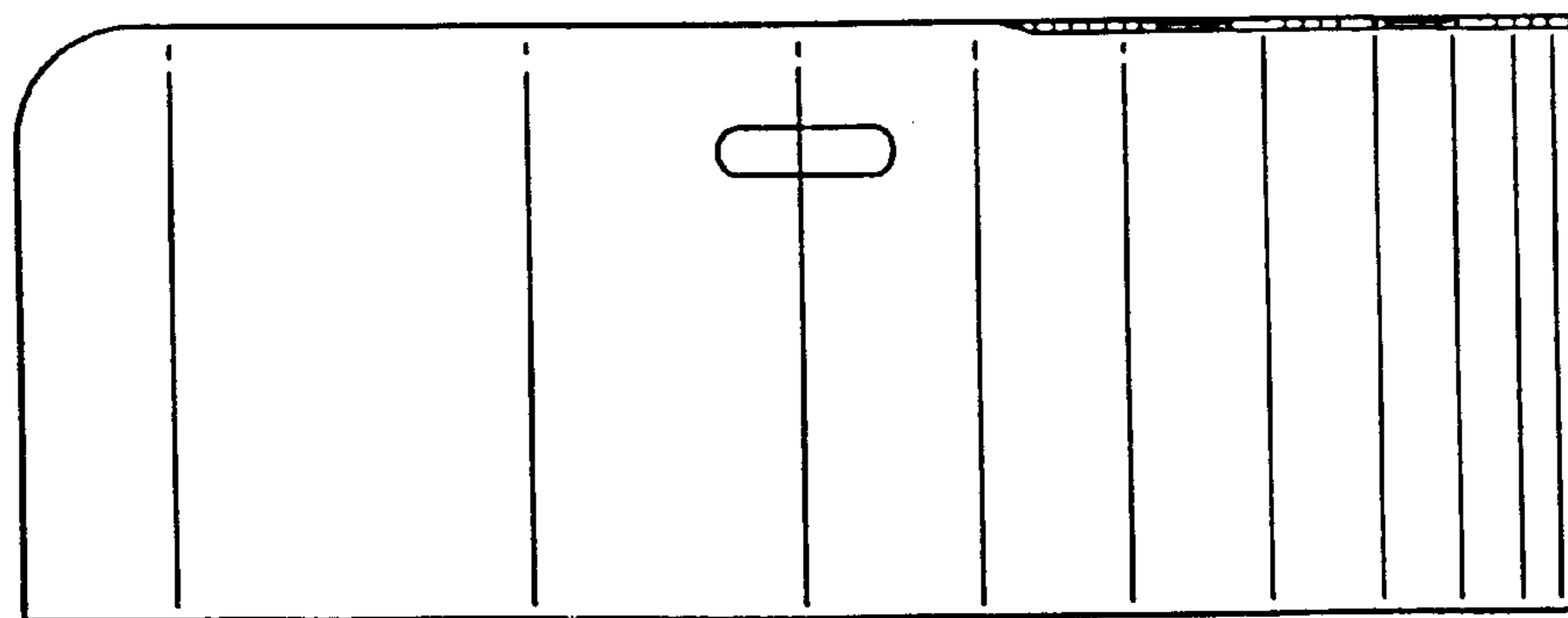

FIG. 5

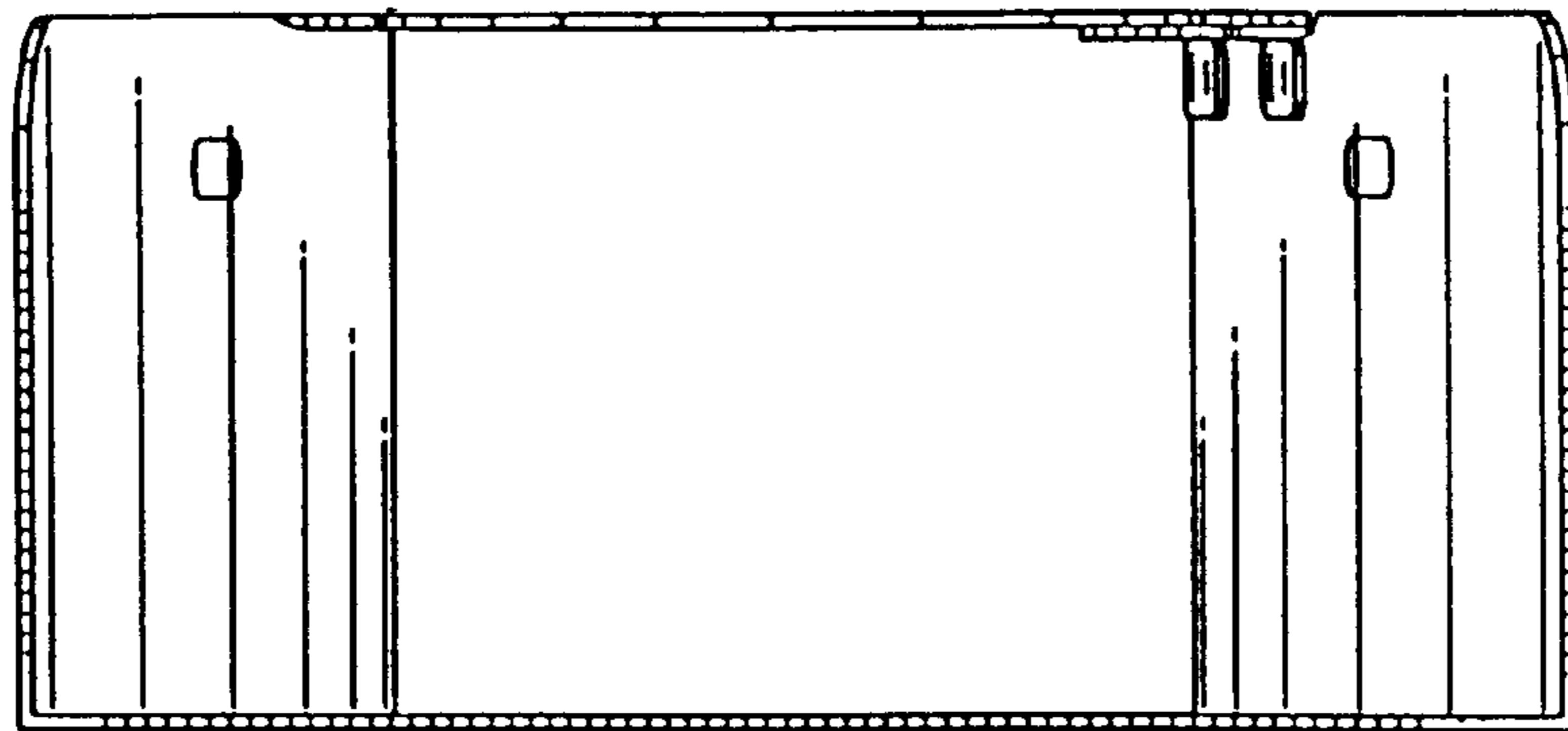

FIG. 6

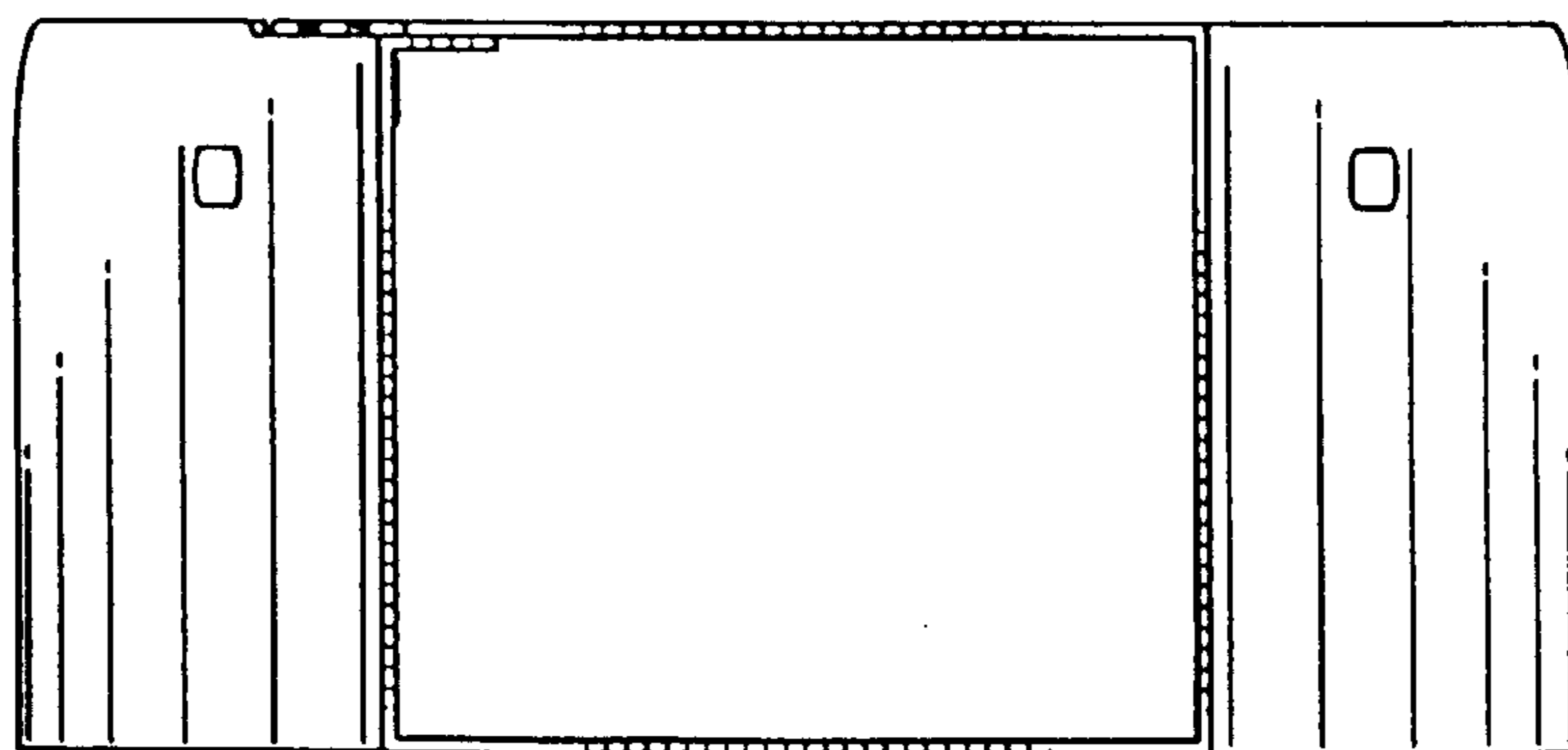

FIG. 7