



US00D513346S

(12) **United States Design Patent**  
**Buck, Jr.**

(10) **Patent No.: US D513,346 S**  
(45) **Date of Patent: \*\* Dec. 27, 2005**

(54) **HAIR TRIMMER STAND WITH ACCESSORY TRAY**

(75) Inventor: **Robert Buck, Jr.**, Rock Falls, IL (US)

(73) Assignee: **Wahl Clipper Corporation**, Sterling, IL (US)

(\*\*) Term: **14 Years**

(21) Appl. No.: **29/185,977**

(22) Filed: **Jul. 7, 2003**

(51) **LOC (6) Cl.** ..... **28-03**

(52) **U.S. Cl.** ..... **D28/73**

(58) **Field of Search** ..... D28/53, 54, 73;  
320/114, 115; 248/176.1; D13/108; D6/526;  
30/531, DIG. 1

(56) **References Cited**

**U.S. PATENT DOCUMENTS**

D287,648 S	*	1/1987	Wahl et al.	.....	D28/53
D339,655 S	*	9/1993	Sulik	.....	D28/53
D360,485 S	*	7/1995	Simonelli	.....	D28/73
D426,676 S		6/2000	Bushman	.....	D28/73
D435,938 S		1/2001	Bushman	.....	D28/73
D455,397 S	*	4/2002	Weiner et al.	.....	D13/108
D465,304 S		11/2002	Bushman	.....	D28/73
D466,700 S	*	12/2002	Richmond et al.	.....	D13/108
D469,221 S		1/2003	Cozzolino et al.	.....	D28/73
D471,578 S	*	3/2003	Okuley	.....	D13/108
2002/0153863 A1	*	10/2002	Arndt	.....	320/115

\* cited by examiner

*Primary Examiner*—Jennifer Rivard

(74) *Attorney, Agent, or Firm*—Greer, Burns, & Crain, Ltd.

(57) **CLAIM**

I claim the ornamental design for the hair trimmer stand with accessory tray, as shown and described.

**DESCRIPTION**

FIG. 1 is a perspective view of one embodiment of a hair trimmer stand of the present invention, shown with an accessory tray;

FIG. 2 is a front view of the hair trimmer stand with accessory tray of FIG. 1;

FIG. 3 is a right side view of the hair trimmer stand with accessory tray of FIG. 1;

FIG. 4 is a left side view of the hair trimmer stand with accessory tray of FIG. 1;

FIG. 5 is a rear view of the hair trimmer stand with accessory tray of FIG. 1;

FIG. 6 is a top view of the hair trimmer stand with accessory tray of FIG. 1;

FIG. 7 is a bottom view of the hair trimmer stand with accessory tray of FIG. 1;

FIG. 8 is a perspective view of an alternate embodiment of the hair trimmer stand with accessory tray of the present invention;

FIG. 9 is a front view of the hair trimmer stand with accessory tray of FIG. 8;

FIG. 10 is a right side view of the hair trimmer stand with accessory tray of FIG. 8;

FIG. 11 is a left side view of the hair trimmer stand with accessory tray of FIG. 8;

FIG. 12 is a rear view of the hair trimmer stand with accessory tray of FIG. 8;

FIG. 13 is a top view of the hair trimmer stand with accessory tray of FIG. 8; and,

FIG. 14 is a bottom view of the hair trimmer stand with accessory tray of FIG. 8.

The broken lines are shown for illustrative purposes only and form no part of the claimed design.

**1 Claim, 4 Drawing Sheets**

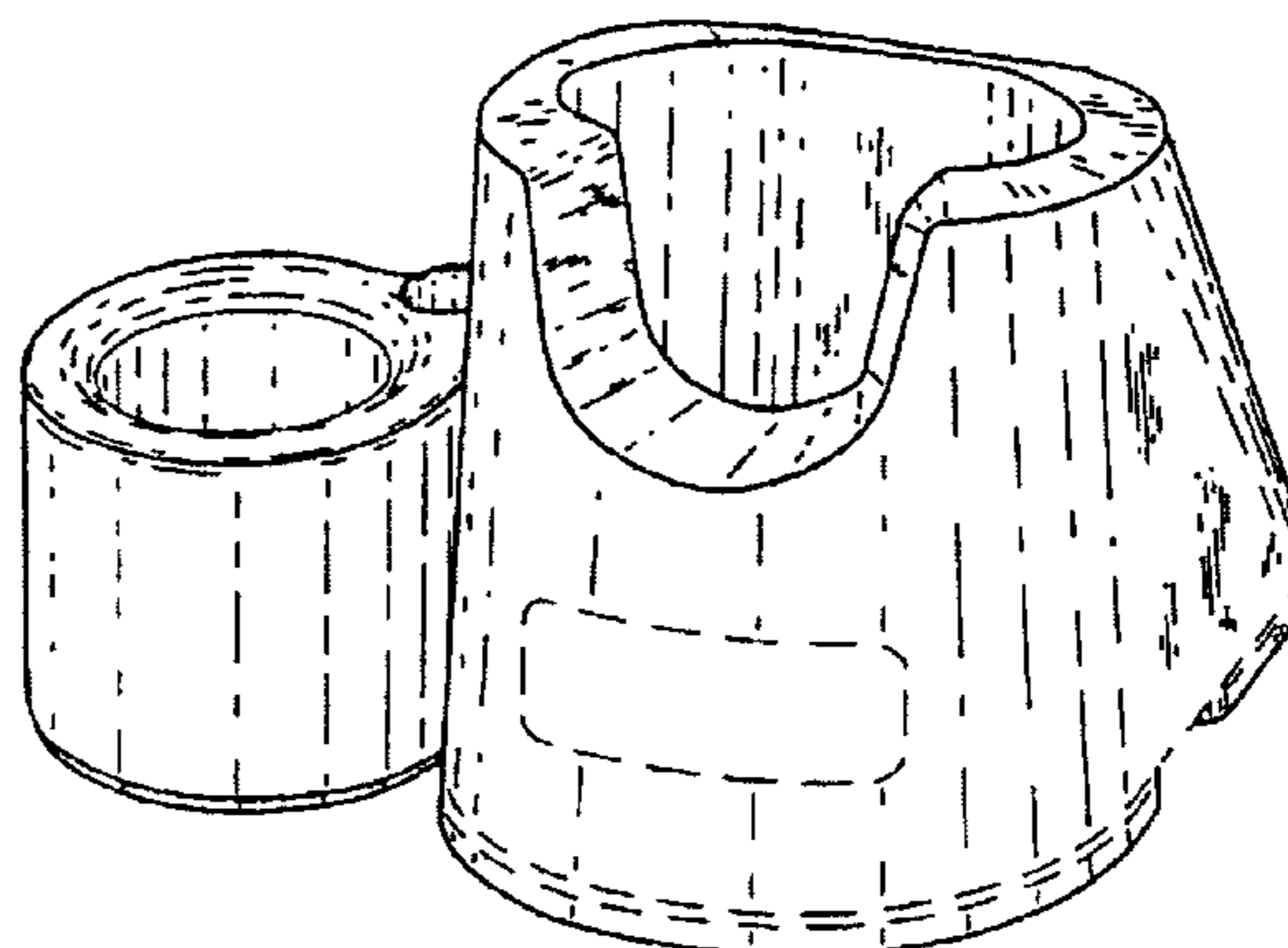
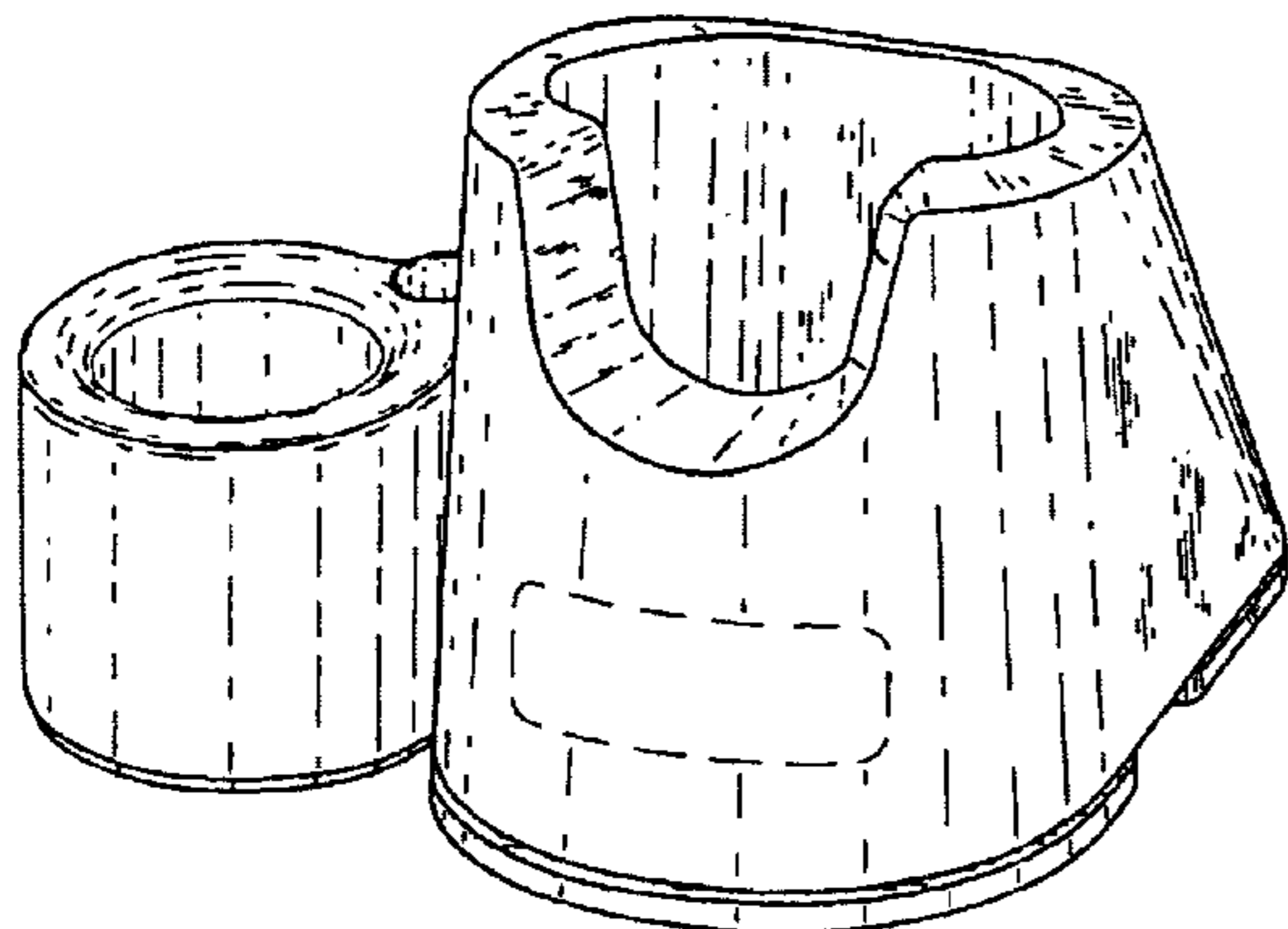

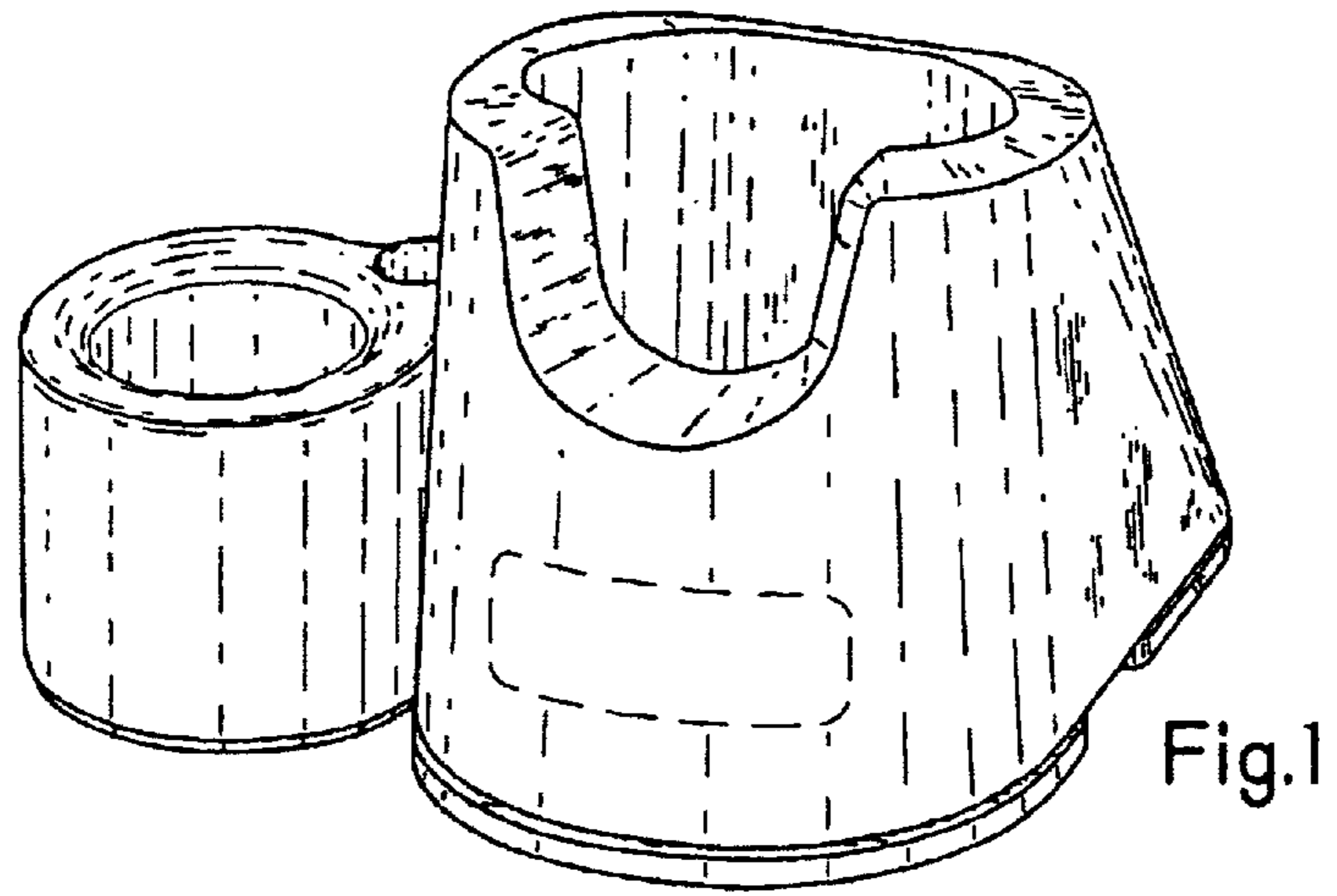

Fig.1

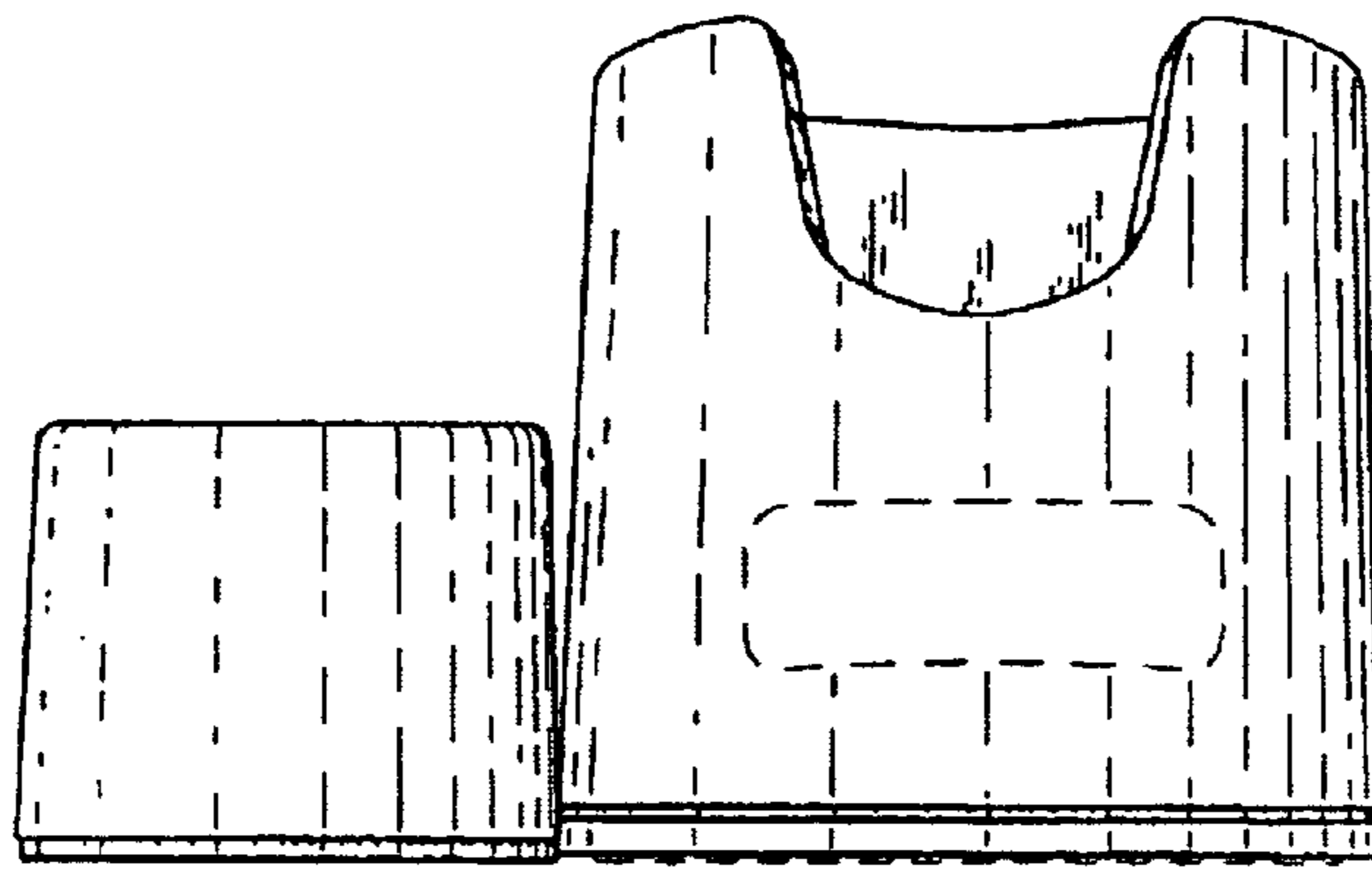

Fig.2

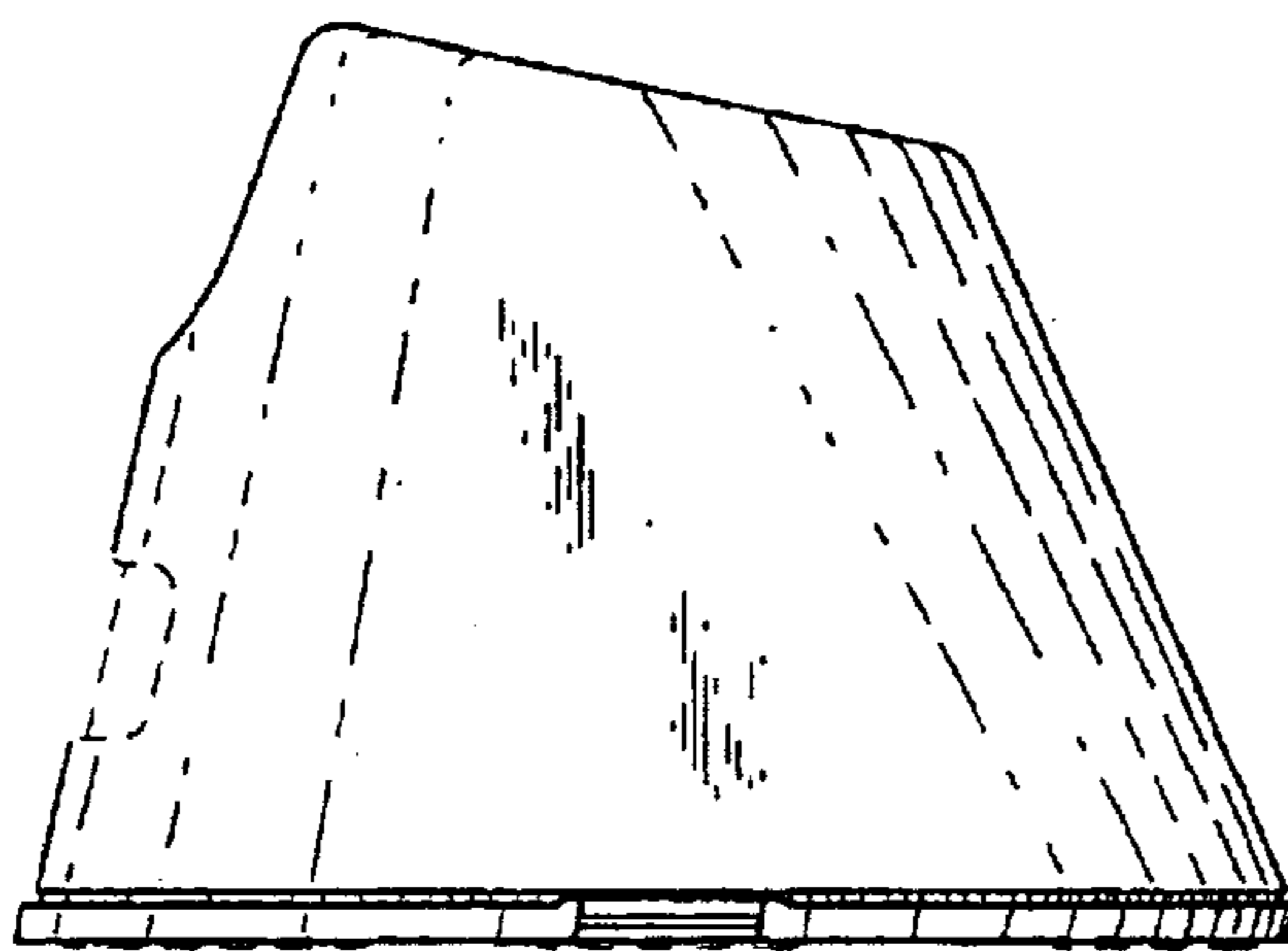

Fig.3

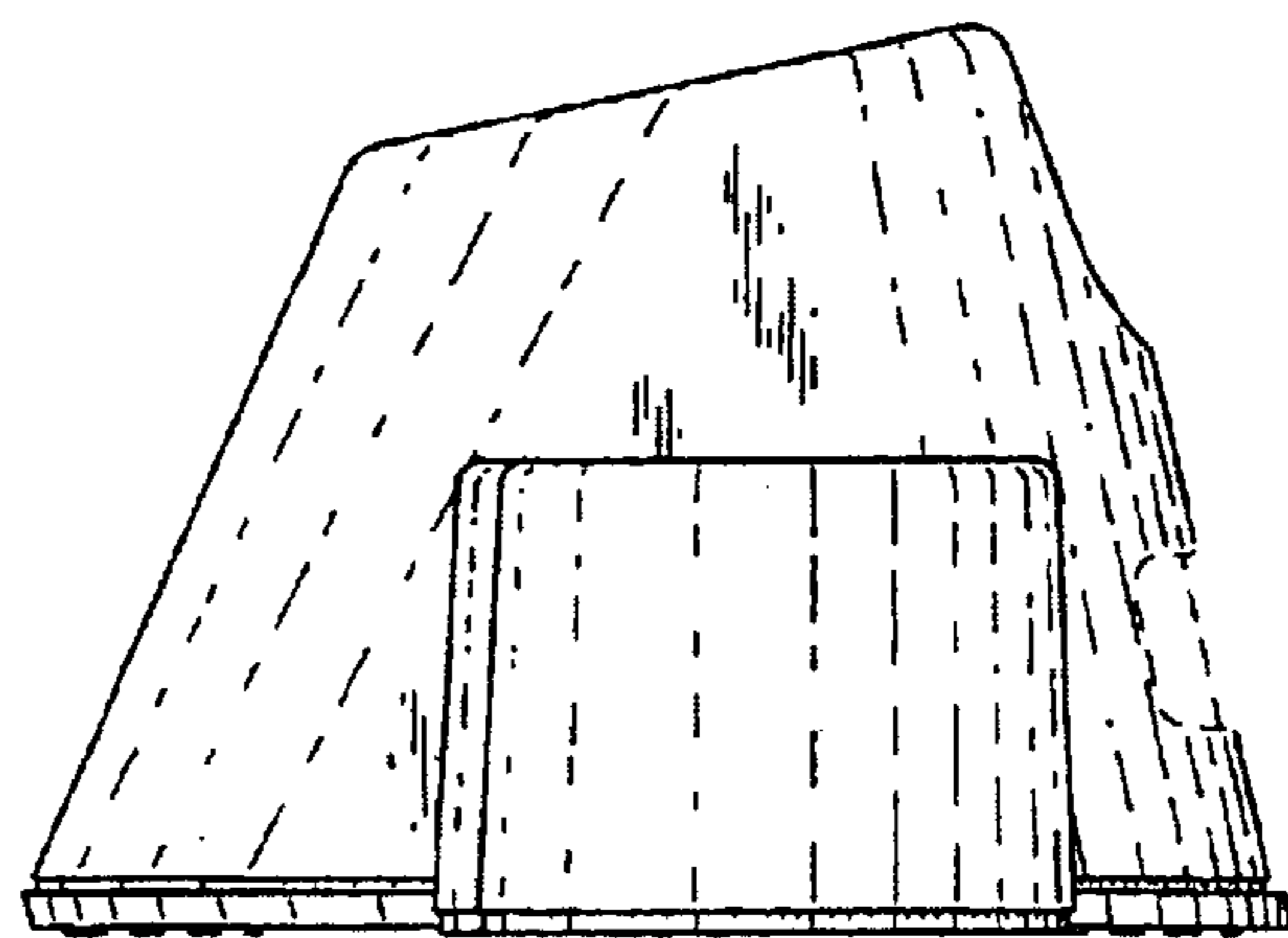

Fig.4

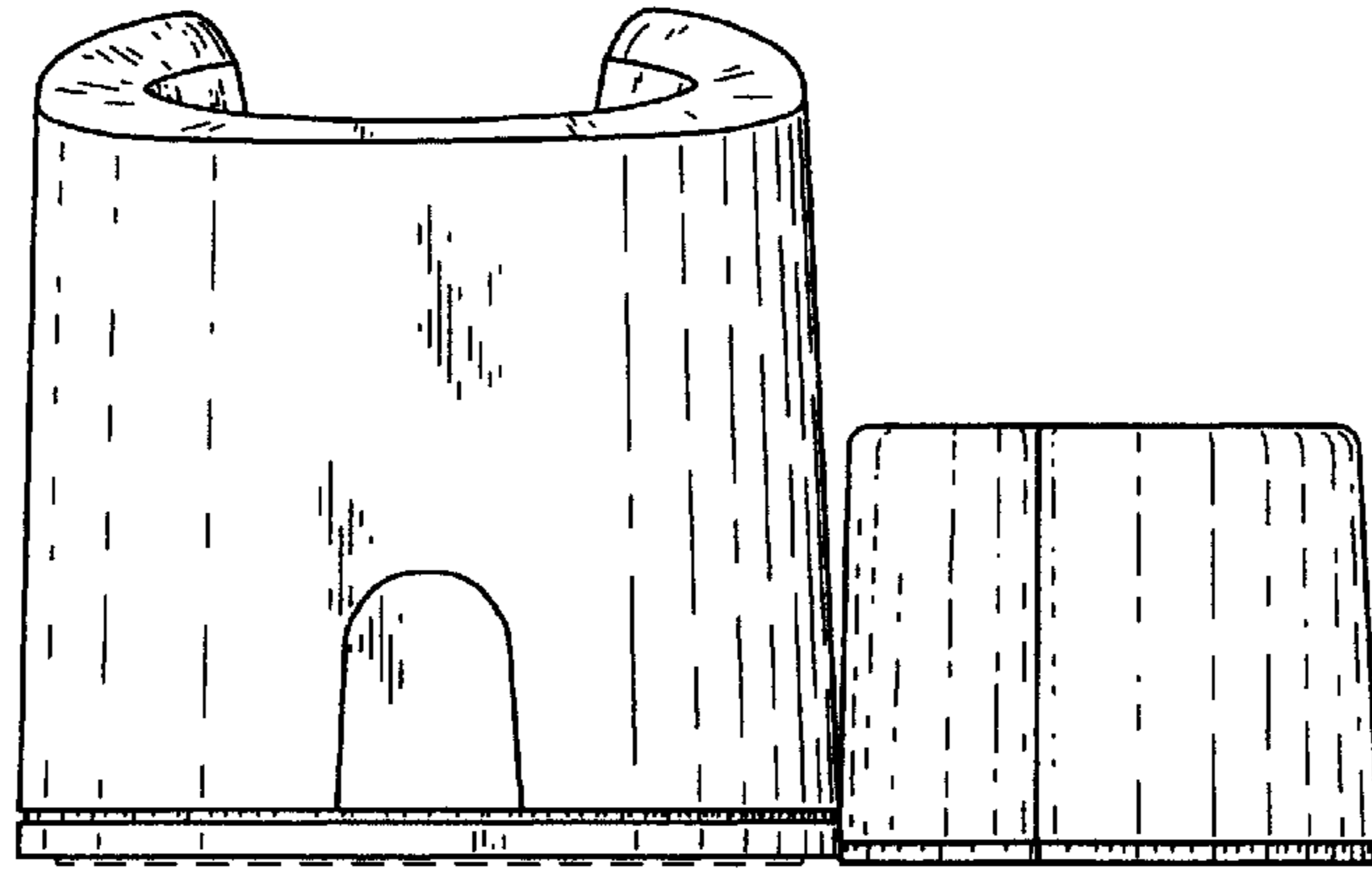

Fig. 5

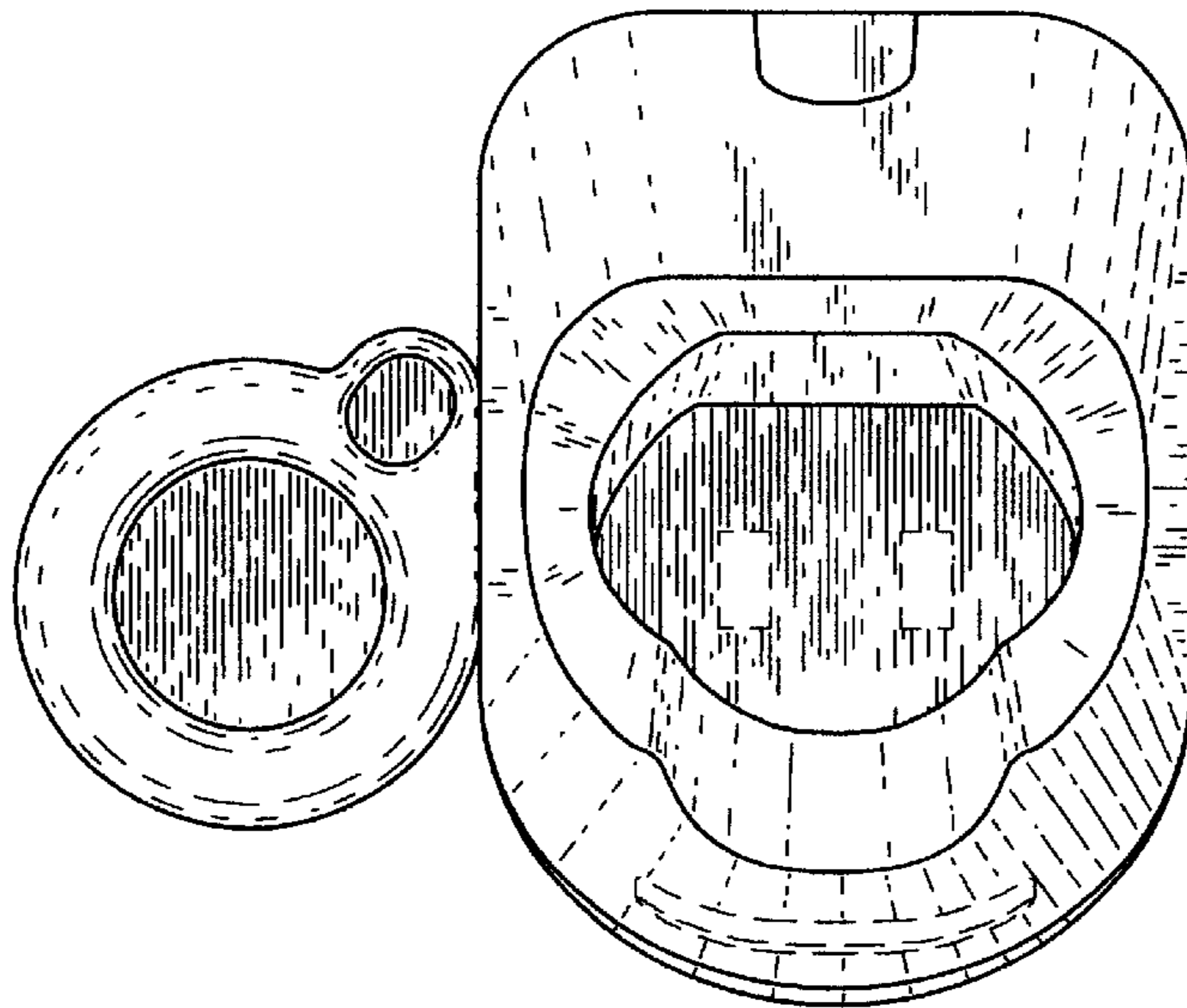

Fig. 6

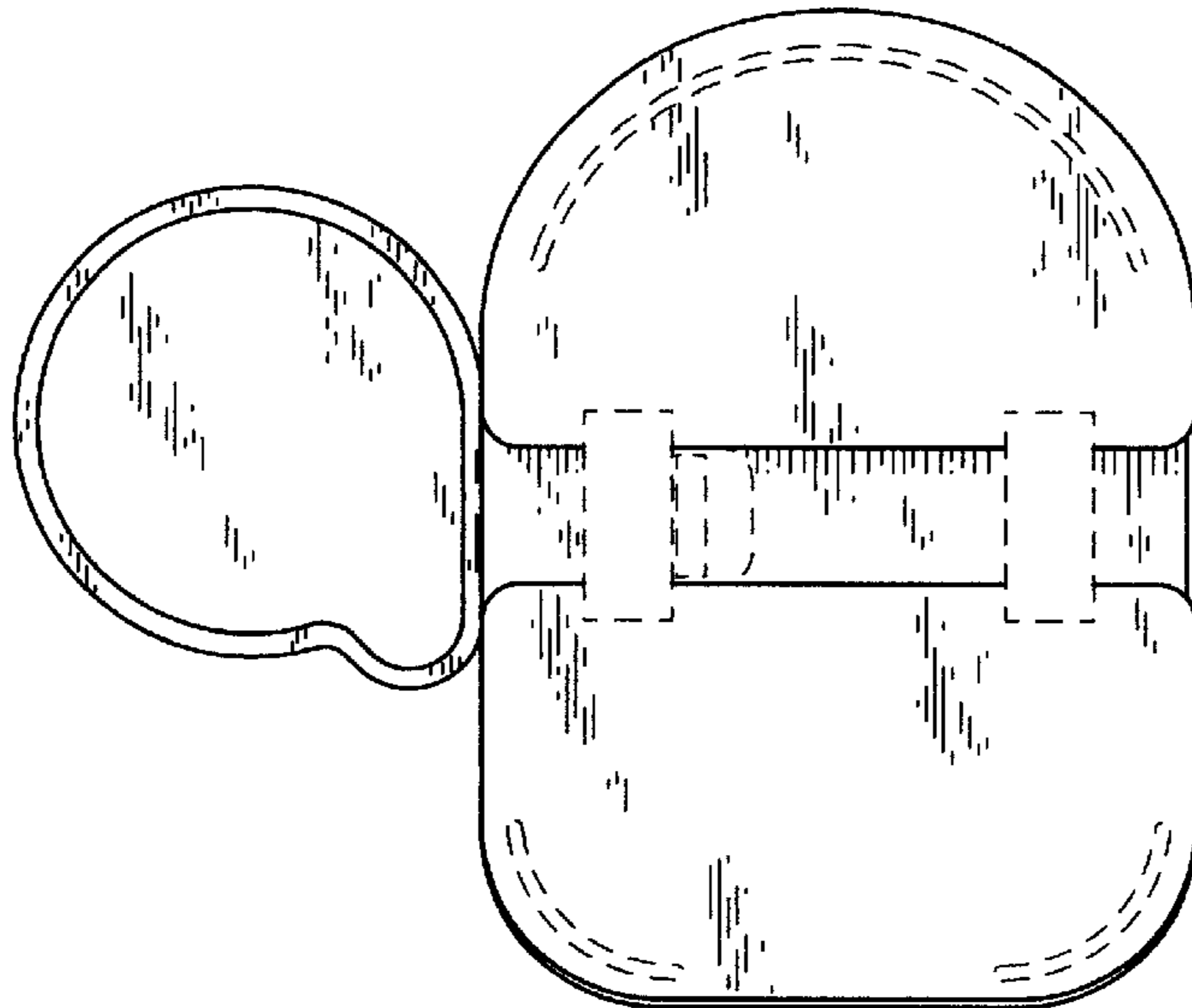
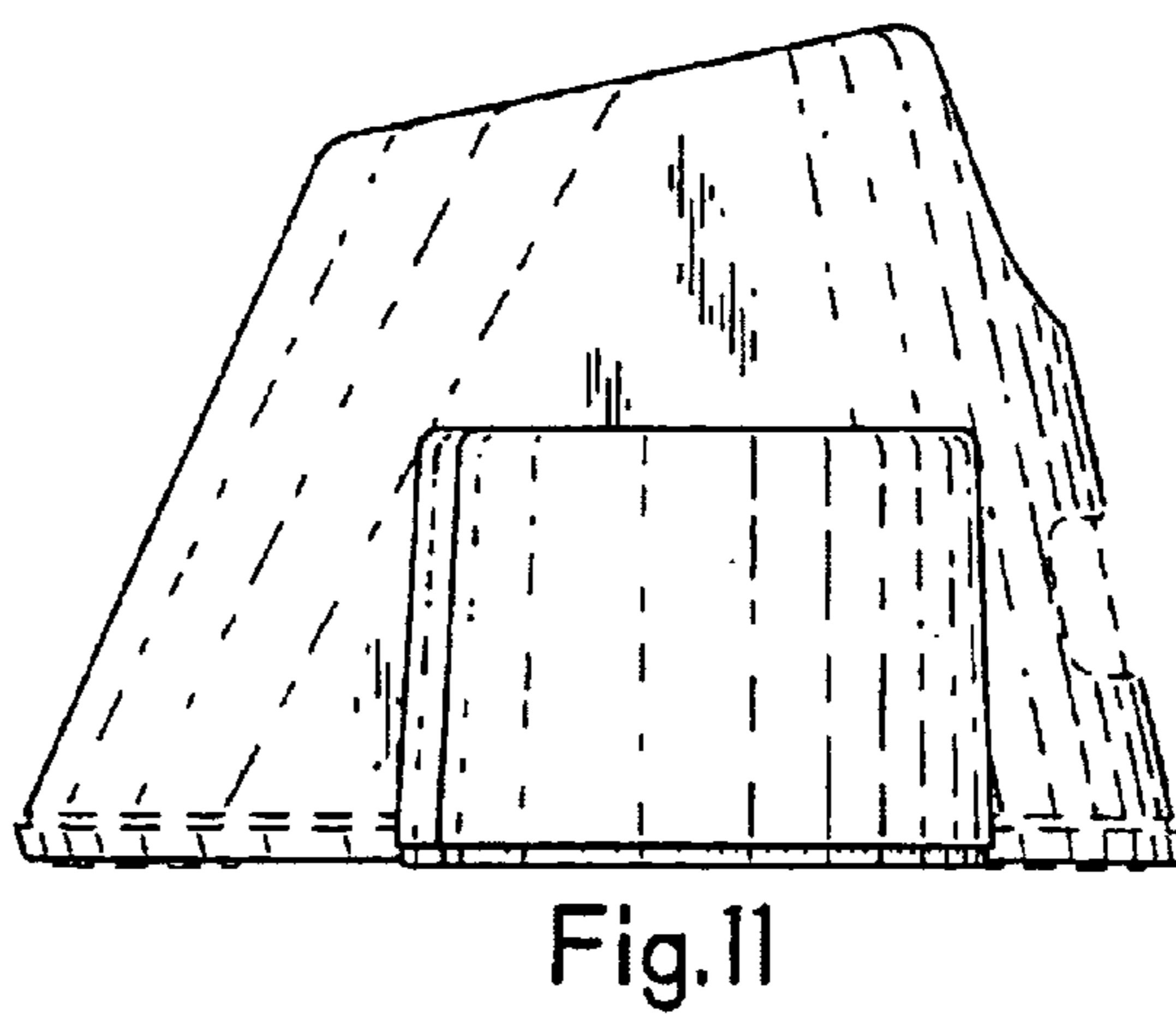
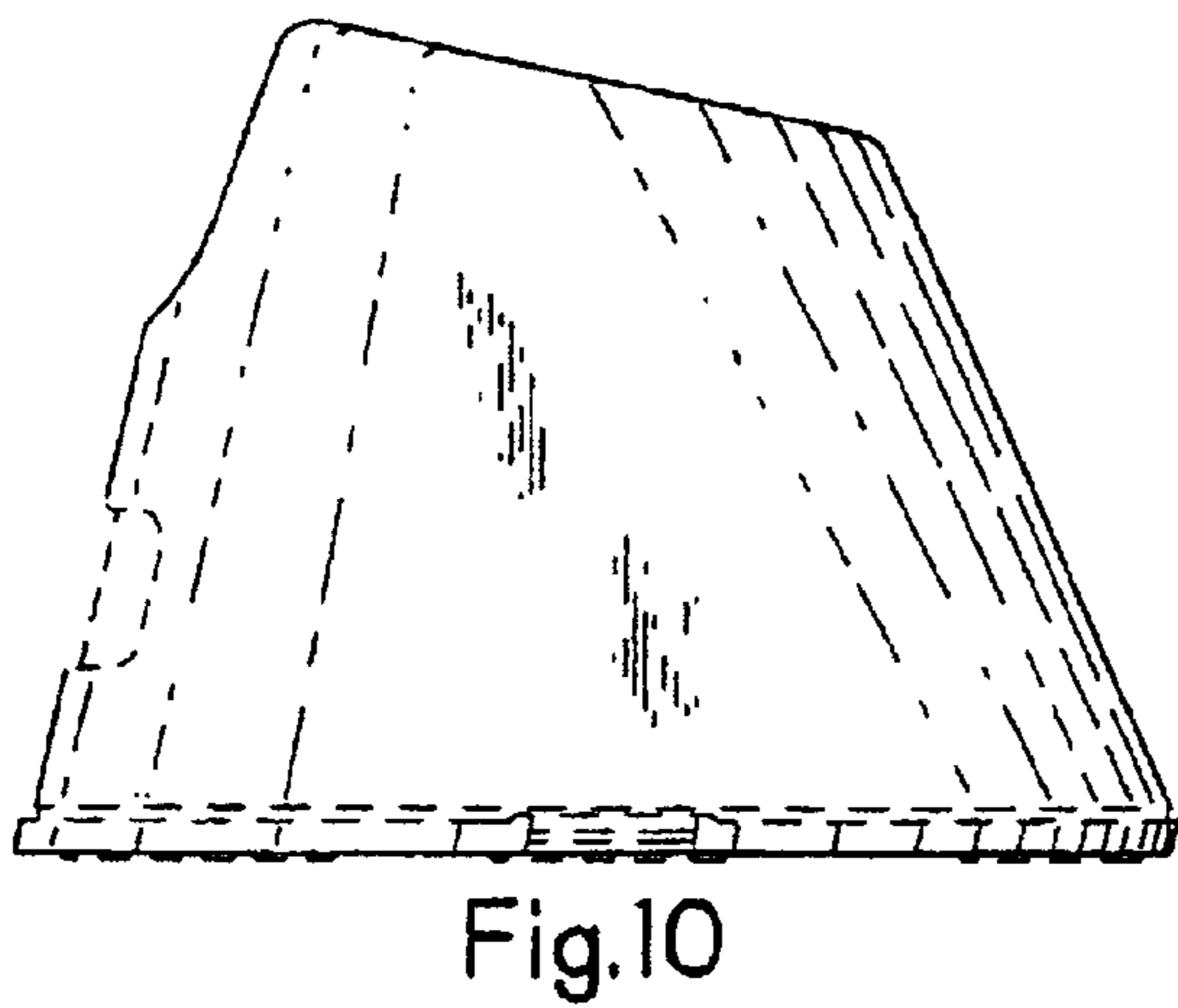
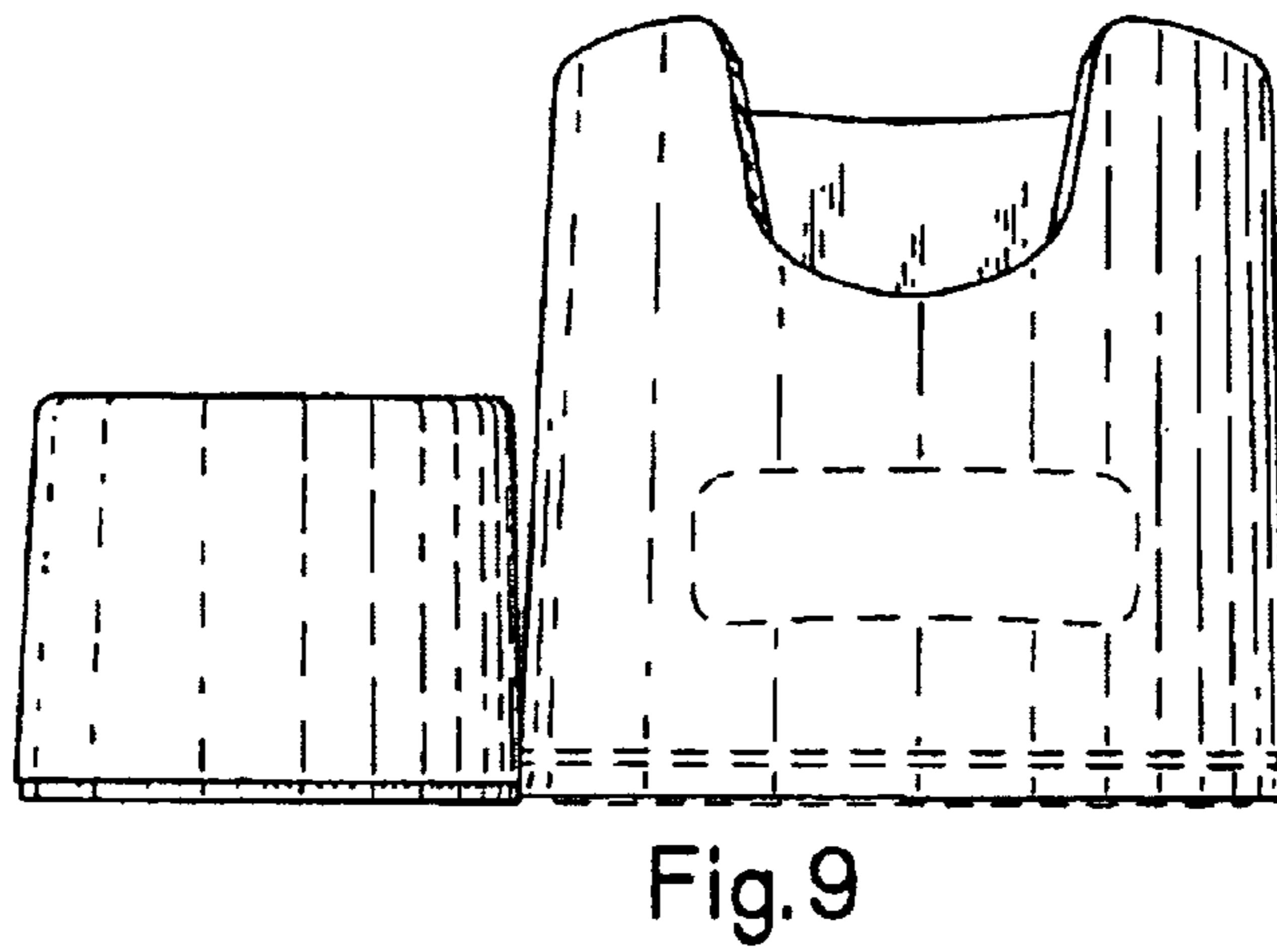
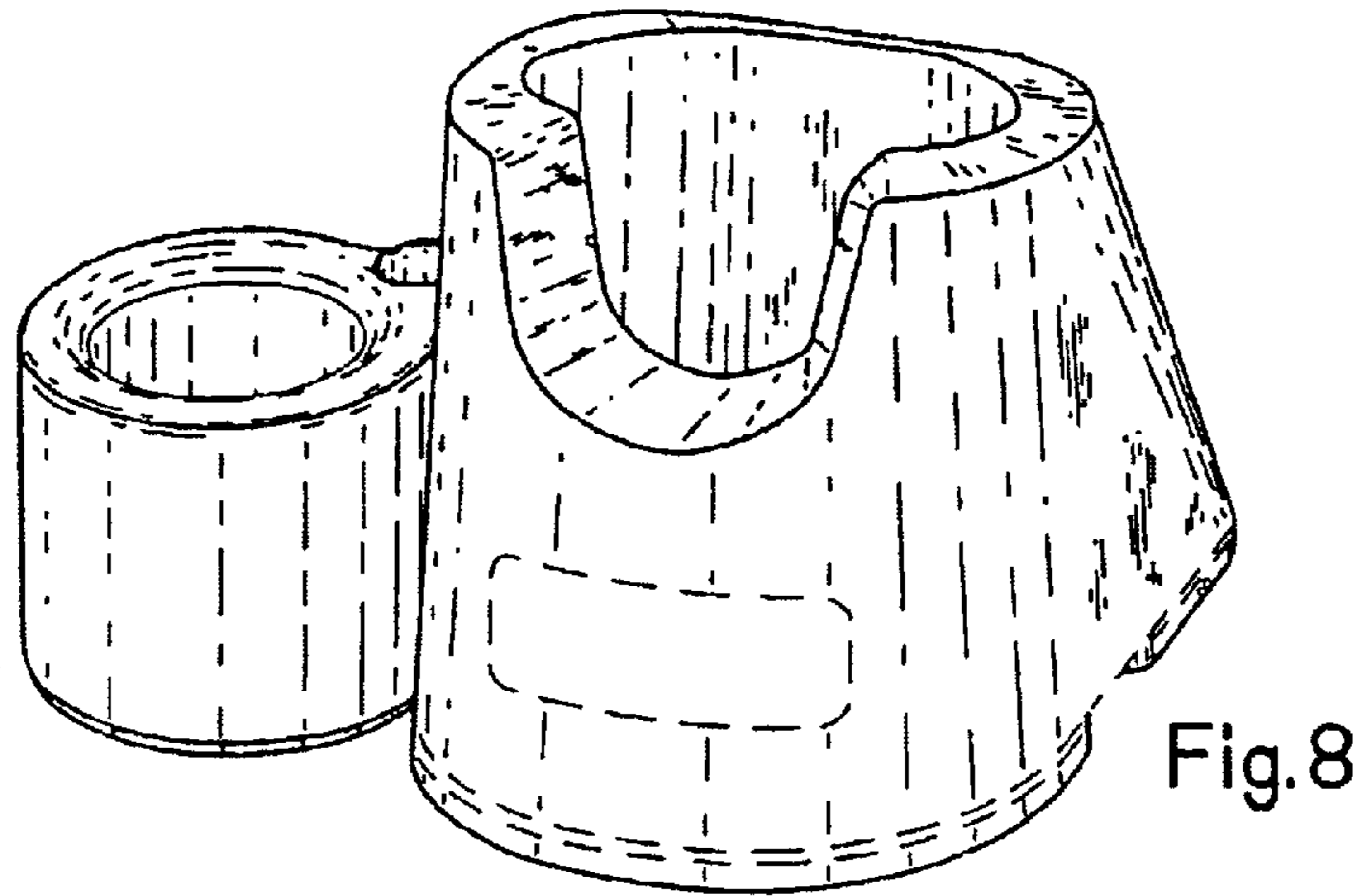

Fig. 7



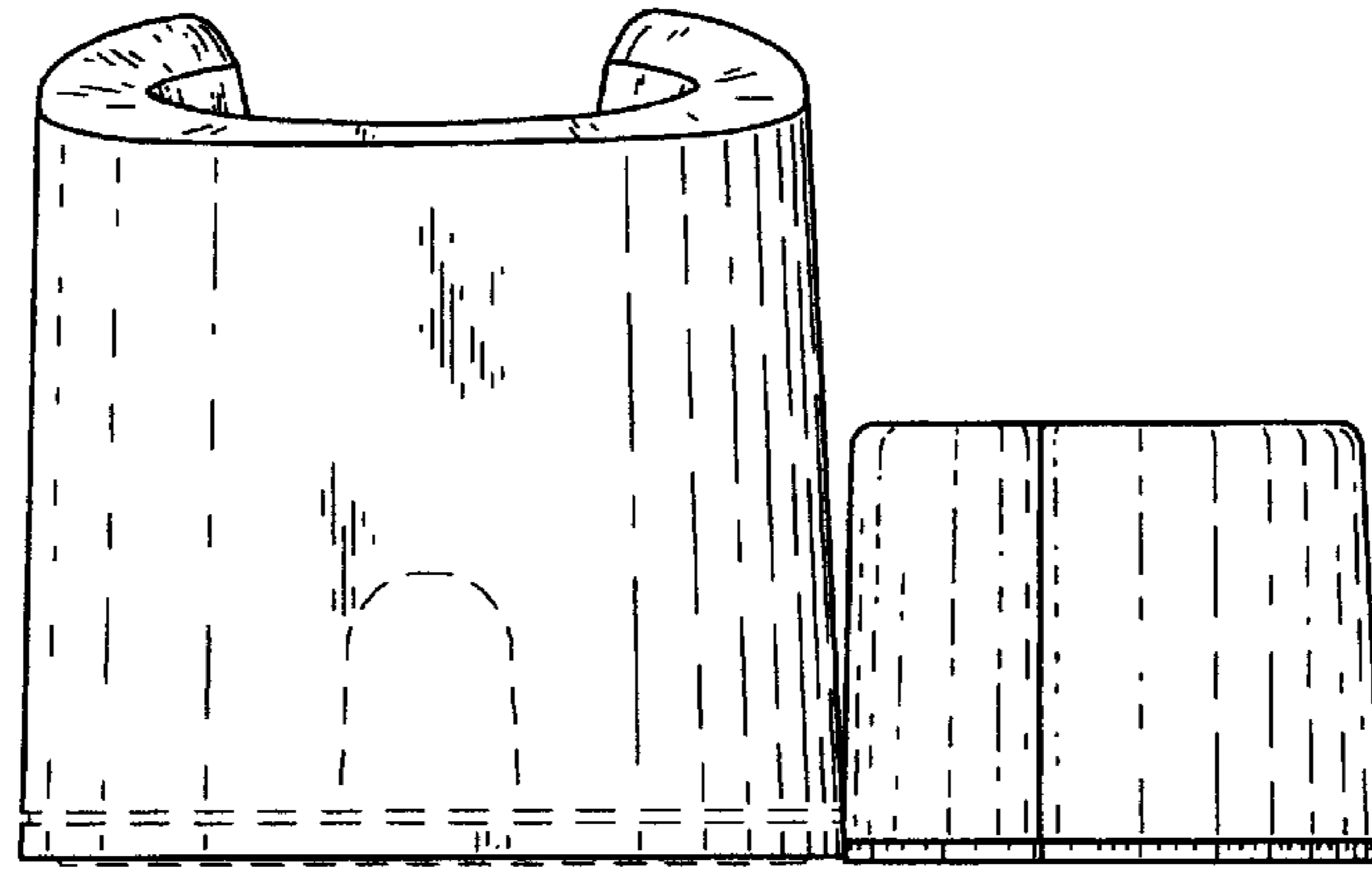

Fig.12

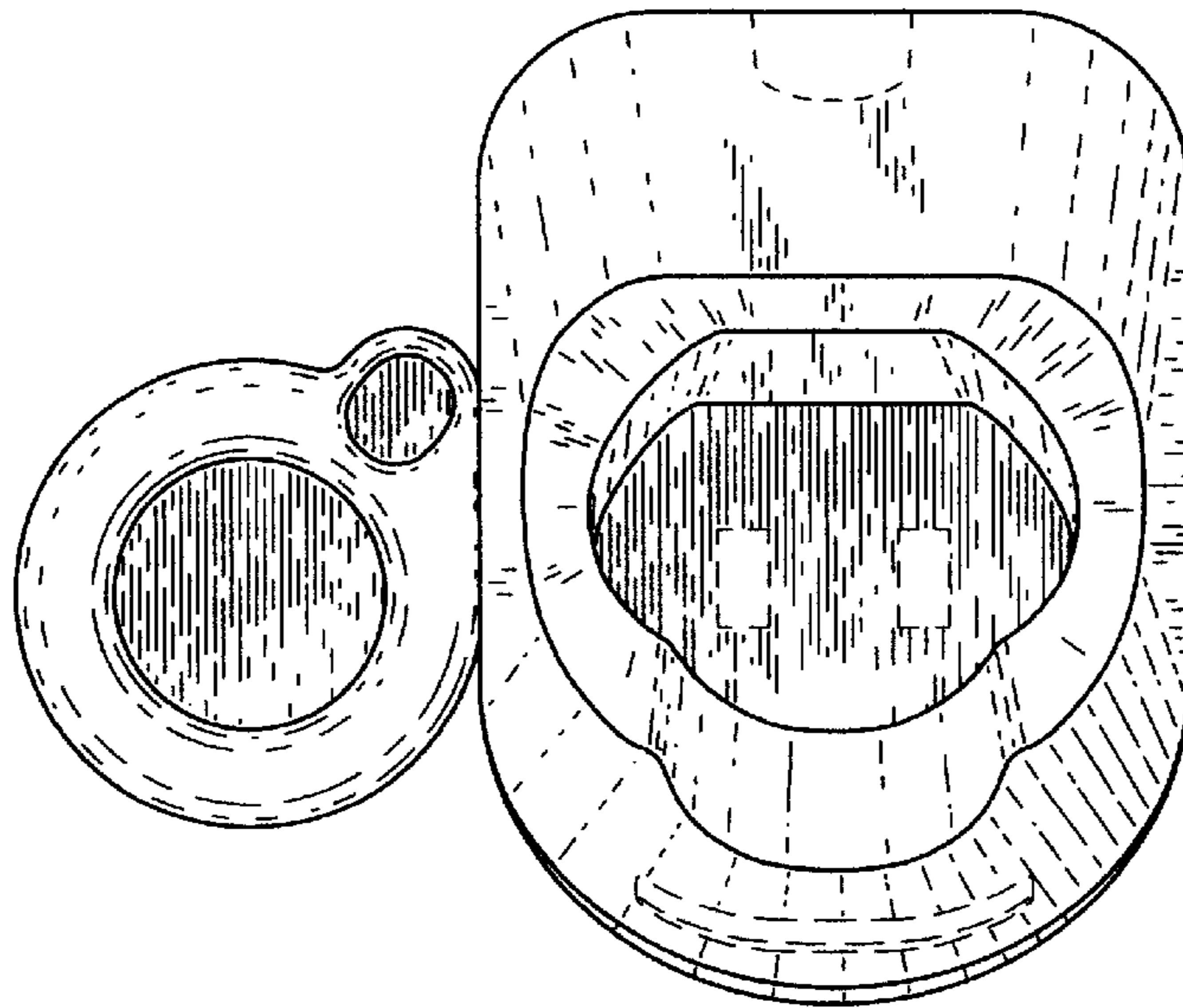

Fig.13

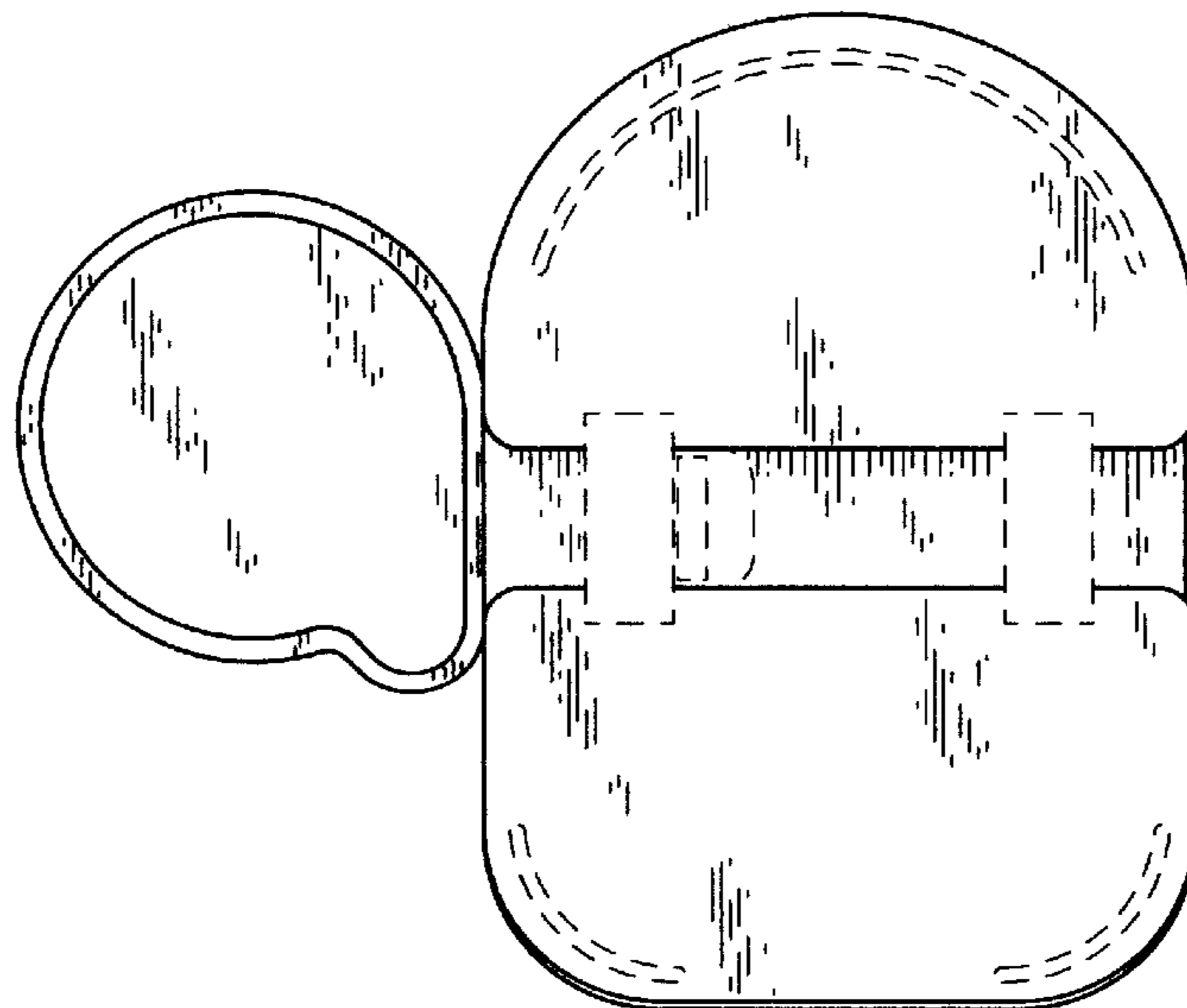

Fig.14