



US00D513300S

(12) **United States Design Patent** (10) **Patent No.:** **US D513,300 S**  
**Rae** (45) **Date of Patent:** **\*\* Dec. 27, 2005**

(54) **KNIFE HANDLE**  
(75) Inventor: **Kit Rae**, Kodak, TN (US)  
(73) Assignee: **United Cutlery Corporation**,  
Sevierville, TN (US)  
(\*\*) Term: **14 Years**  
(21) Appl. No.: **29/215,889**  
(22) Filed: **Oct. 26, 2004**  
(51) **LOC (6) Cl.** ..... **22-02**  
(52) **U.S. Cl.** ..... **D22/118**  
(58) **Field of Search** ..... D22/117-120;  
D8/95-99; D21/568; 30/294, 295, 151-154,  
160

(56) **References Cited**

**U.S. PATENT DOCUMENTS**

D137,451 S	3/1944	Harstad	.....	D22/118
D138,570 S	8/1944	Huff	.....	D22/118
D156,070 S	11/1949	Brooks	.....	D22/118
D170,824 S	11/1953	Kundikoff	.....	D22/118
D221,335 S	8/1971	Clayton	.....	D22/118
D222,934 S	2/1972	Cole	.....	D22/118
D222,935 S	2/1972	Cole	.....	D22/118
D222,937 S	2/1972	Cole	.....	D22/118
D222,938 S	2/1972	Cole	.....	D22/118
D225,527 S	12/1972	Cole	.....	D22/118
4,608,757 A	9/1986	Eckerle	.....	30/299
D299,375 S	1/1989	Pipes	.....	D22/118
D302,455 S	7/1989	Hibben	.....	D22/118
4,885,818 A	12/1989	Arterbury	.....	30/314
D319,280 S	8/1991	Crain	.....	D22/118
D323,694 S	2/1992	Pipes	.....	D22/118
D325,616 S	4/1992	Kolombatovich	.....	D22/118
D330,064 S	10/1992	Medina	.....	D22/118
D333,173 S	2/1993	Pipes	.....	D22/118
D336,126 S	6/1993	Luchak	.....	D22/118
D348,599 S	7/1994	Sakai	.....	D8/99
D348,818 S	7/1994	Hasegawa	.....	D22/118
D351,210 S	10/1994	Koskinen	.....	D22/118
5,359,778 A	11/1994	Seber et al.	.....	30/294

D360,013 S	7/1995	Collins	.....	D22/118
D360,241 S	7/1995	Choi	.....	D21/568
D361,104 S	8/1995	Choi	.....	D21/568
5,440,814 A	8/1995	Hall et al.	.....	30/206

(Continued)

**OTHER PUBLICATIONS**

U.S. Calvary Knives, 1994, p. 111, Catalog.  
The Noble Collection, Winter 1997/1998, Historic Daggers,  
No page listed, Catalog.  
United Cutlery Brands, Catalog #42, 2002, pp. 7, 19, 21, 29,  
30, 33-35, 39-45 and 51-60.  
Museum Replicas Limited, Horned Skull Sword, p. 65,  
(1994).  
Agincourt, Iberia Sword, Item B, Cutlery Shoppe, p. 38  
(1993).  
United Cutlery, Double Shadow Fantasy Dagger, p. 16,  
(1991).

*Primary Examiner*—Catherine R. Oliver  
(74) *Attorney, Agent, or Firm*—Pitts & Brittan, P.C.

(57) **CLAIM**

I claim the ornamental design for a knife handle, as shown  
and described.

**DESCRIPTION**

FIG. 1 is a perspective view of the design of the present  
invention for a knife handle;  
FIG. 2 is a front elevation view of the knife handle of FIG.  
1;  
FIG. 3 is a rear elevation view of the knife handle of FIG.  
1;  
FIG. 4 is a left side elevation view of the knife handle of  
FIG. 1, the right side elevation being a mirror image thereof;  
FIG. 5 is a top end view of the knife handle of FIG. 1; and,  
FIG. 6 is a bottom end view of the knife handle of FIG. 1.  
The features of the knife blade shown in broken lines are for  
illustrative purposes only and form no part of the claimed  
design.

**1 Claim, 4 Drawing Sheets**

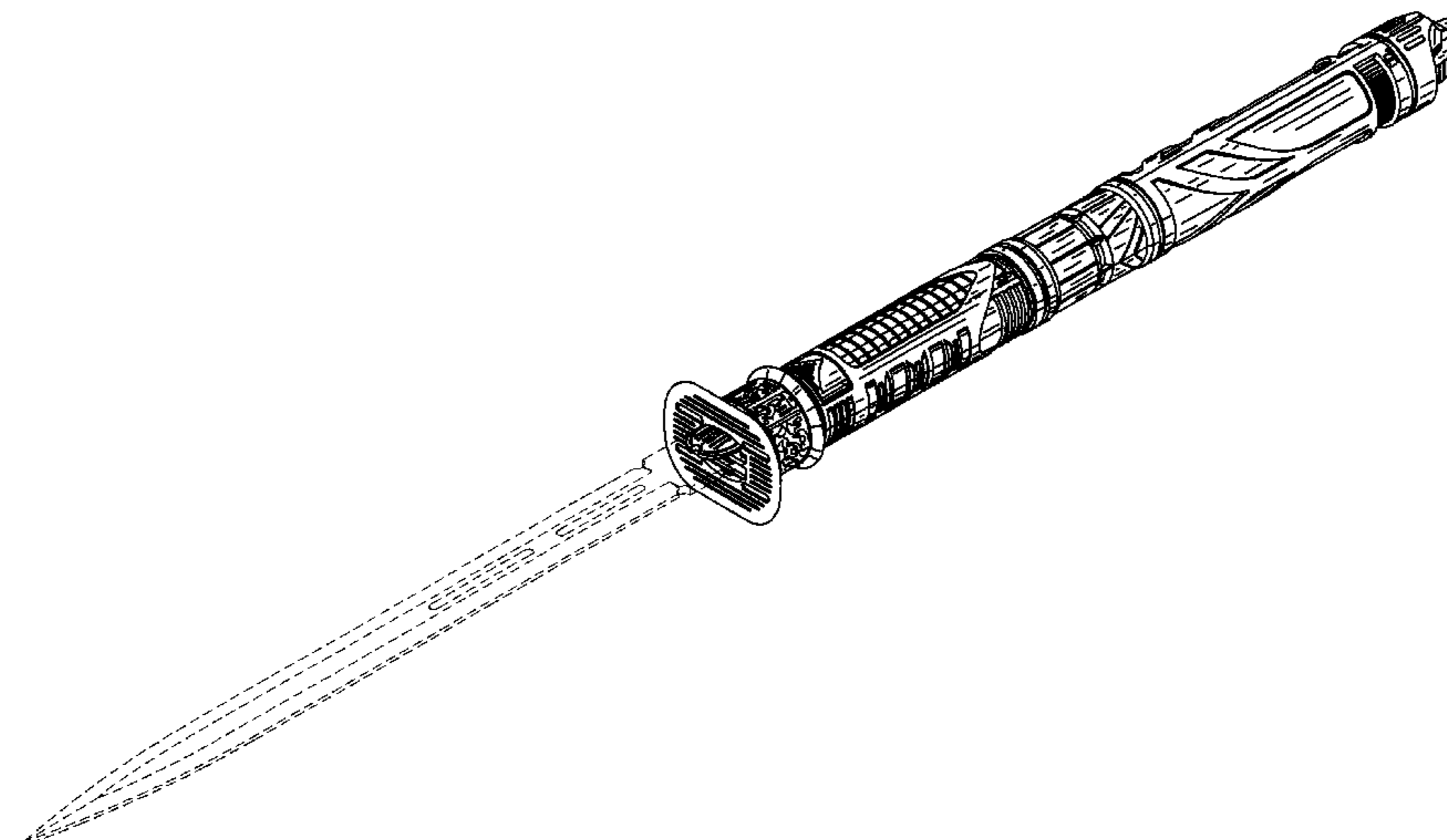

# US D513,300 S

Page 2

## U.S. PATENT DOCUMENTS

D362,485 S	9/1995	Hall .....	D22/118	D473,912 S	4/2003	Rae .....	D22/118
D363,109 S	10/1995	Hall .....	D8/107	D473,913 S	4/2003	Hall .....	D22/118
D371,060 S	6/1996	Lai .....	D22/118	D473,914 S	4/2003	Rae .....	D22/118
D371,592 S	7/1996	Hall et al. ....	D22/118	D473,915 S	* 4/2003	Hall .....	D22/118
D375,779 S	11/1996	Hibben .....	D22/118	D473,916 S	* 4/2003	Rae .....	D22/118
D378,982 S	4/1997	Thompson .....	D22/118	D473,917 S	* 4/2003	Carter, III .....	D22/118
D379,211 S	5/1997	Thompson .....	D22/118	D473,918 S	* 4/2003	Rae .....	D22/118
D379,488 S	5/1997	Hibben .....	D22/118	D473,919 S	* 4/2003	Rae .....	D22/118
D380,520 S	7/1997	Hibben .....	D22/118	D473,920 S	* 4/2003	Rae .....	D22/118
D381,060 S	7/1997	Moran .....	D22/118	D473,921 S	* 4/2003	Rae .....	D22/118
D382,187 S	8/1997	Hibben .....	D22/118	D473,922 S	* 4/2003	Rae .....	D22/118
D383,519 S	9/1997	Lainhart .....	D22/118	D473,923 S	* 4/2003	Rae .....	D22/118
D388,150 S	12/1997	Glessner .....	D22/118	D473,924 S	* 4/2003	Rae .....	D22/118
D398,211 S	9/1998	Howard .....	D22/118	D474,828 S	* 5/2003	Rae .....	D22/118
D406,308 S	3/1999	Hibben .....	D22/118	D474,829 S	* 5/2003	Rae .....	D22/118
D409,269 S	5/1999	Carson et al. ....	D22/118	D475,114 S	* 5/2003	Rae et al. ....	D22/118
D430,258 S	8/2000	Hall et al. ....	D22/118	D475,431 S	* 6/2003	Rae .....	D22/118
D430,917 S	9/2000	Hall et al. ....	D22/118	D478,957 S	* 8/2003	Rae et al. ....	D22/118
D434,466 S	11/2000	Hall et al. ....	D22/118	D480,778 S	* 10/2003	Rae .....	D22/118
D446,571 S	8/2001	Frazer .....	D22/118	D480,779 S	* 10/2003	Rae .....	D22/118
D448,828 S	10/2001	Karnezis .....	D22/118	D483,433 S	* 12/2003	Rae .....	D22/118
D451,571 S	12/2001	Barker, II .....	D22/118	D483,832 S	* 12/2003	Carter, III et al. ....	D22/118
D451,572 S	12/2001	Barker, II .....	D22/118	D483,833 S	* 12/2003	Rae .....	D22/118
D452,546 S	12/2001	Barker, II .....	D22/118	D484,215 S	12/2003	Carter, III et al. ....	D22/118
D452,547 S	12/2001	Barker, II .....	D22/118	D485,327 S	1/2004	Carter, III et al. ....	D22/118
D452,895 S	1/2002	Rae et al. ....	D22/118	D485,596 S	1/2004	Rae .....	D22/118
D454,611 S	3/2002	Veltz et al. ....	D22/118	D486,201 S	2/2004	Rae .....	D22/118
D461,217 S	8/2002	Hall et al. ....	D22/118	D486,202 S	2/2004	Rae et al. ....	D22/118
D461,868 S	8/2002	Hall et al. ....	D22/118	D486,548 S	2/2004	Rae .....	D22/118
D473,609 S	4/2003	Rae .....	D22/118	D486,549 S	2/2004	Rae .....	D22/118
D473,610 S	4/2003	Rae .....	D22/118	D487,495 S	3/2004	Rae .....	D22/118
D473,611 S	4/2003	Rae .....	D22/118	D487,912 S	3/2004	Rae .....	D22/118
D473,612 S	4/2003	Rae .....	D22/118	D488,697 S	4/2004	Rae .....	D22/118
D473,613 S	4/2003	Rae .....	D22/118	D489,956 S	5/2004	Rae .....	D22/118
D473,614 S	4/2003	Rae .....	D22/118	D491,996 S	6/2004	Rae .....	D22/118
D473,615 S	4/2003	Rae .....	D22/118	D492,749 S	7/2004	Rae .....	D22/118
D473,616 S	4/2003	Rae .....	D22/118	D492,978 S	7/2004	Rae .....	D22/118
D473,617 S	4/2003	Rae .....	D22/118	D493,862 S	8/2004	Rae .....	D22/118
D473,618 S	4/2003	Rae .....	D22/118	D493,863 S	8/2004	Rae .....	D22/118
D473,619 S	4/2003	Rae .....	D22/118	D494,245 S	8/2004	Rae et al. ....	D22/118
D473,620 S	4/2003	Rae .....	D22/118	D494,246 S	8/2004	Rae et al. ....	D22/118
D473,621 S	4/2003	Rae .....	D22/118	D494,440 S	8/2004	Carter, III .....	D22/118
D473,622 S	4/2003	Rae .....	D22/118	D495,393 S	8/2004	Rae .....	D22/118
D473,623 S	4/2003	Rae .....	D22/118	D495,394 S	8/2004	Rae .....	D22/118
D473,624 S	4/2003	Rae .....	D22/118	D495,395 S	8/2004	Rae .....	D22/118
D473,625 S	4/2003	Rae .....	D22/118	D495,772 S	9/2004	Hibben .....	D22/118
D473,626 S	4/2003	Rae .....	D22/118	D496,424 S	9/2004	Carter, III .....	D22/118
D473,627 S	4/2003	Rae .....	D22/118	D496,425 S	9/2004	Carter, III .....	D22/118
D473,911 S	4/2003	Green .....	D22/118				

\* cited by examiner

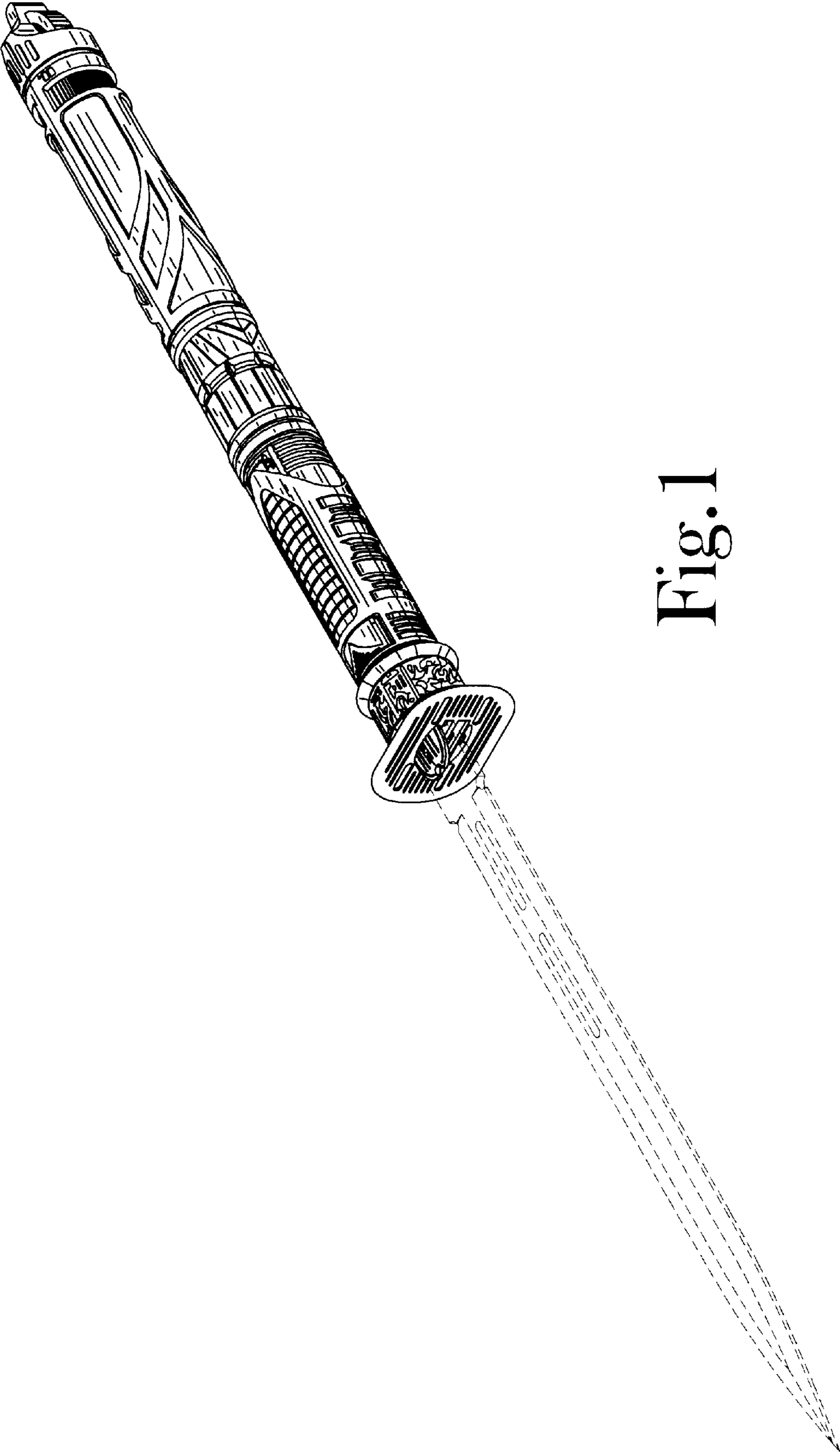

Fig. 1

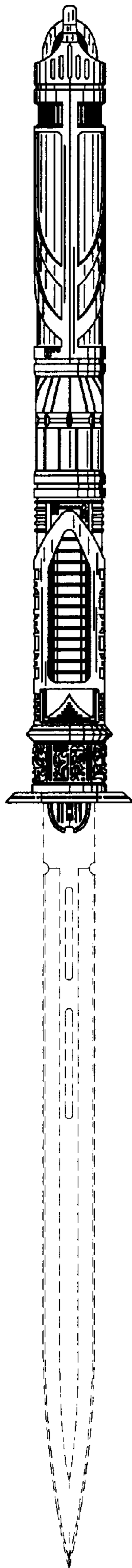

Fig. 2

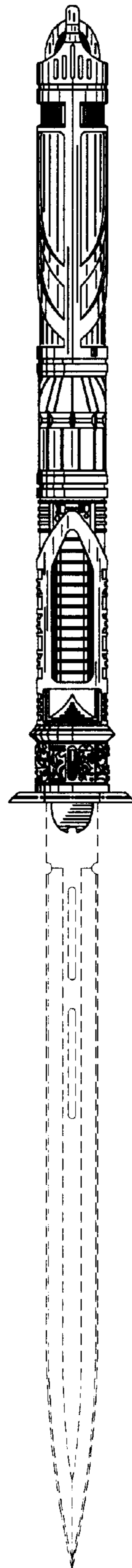

Fig. 3

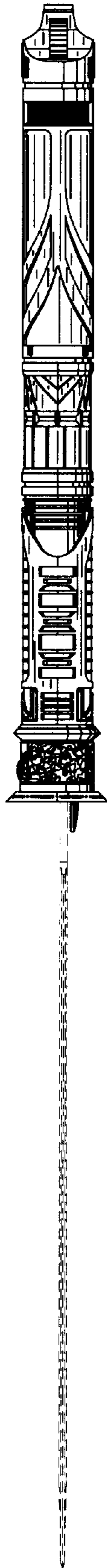

Fig. 4

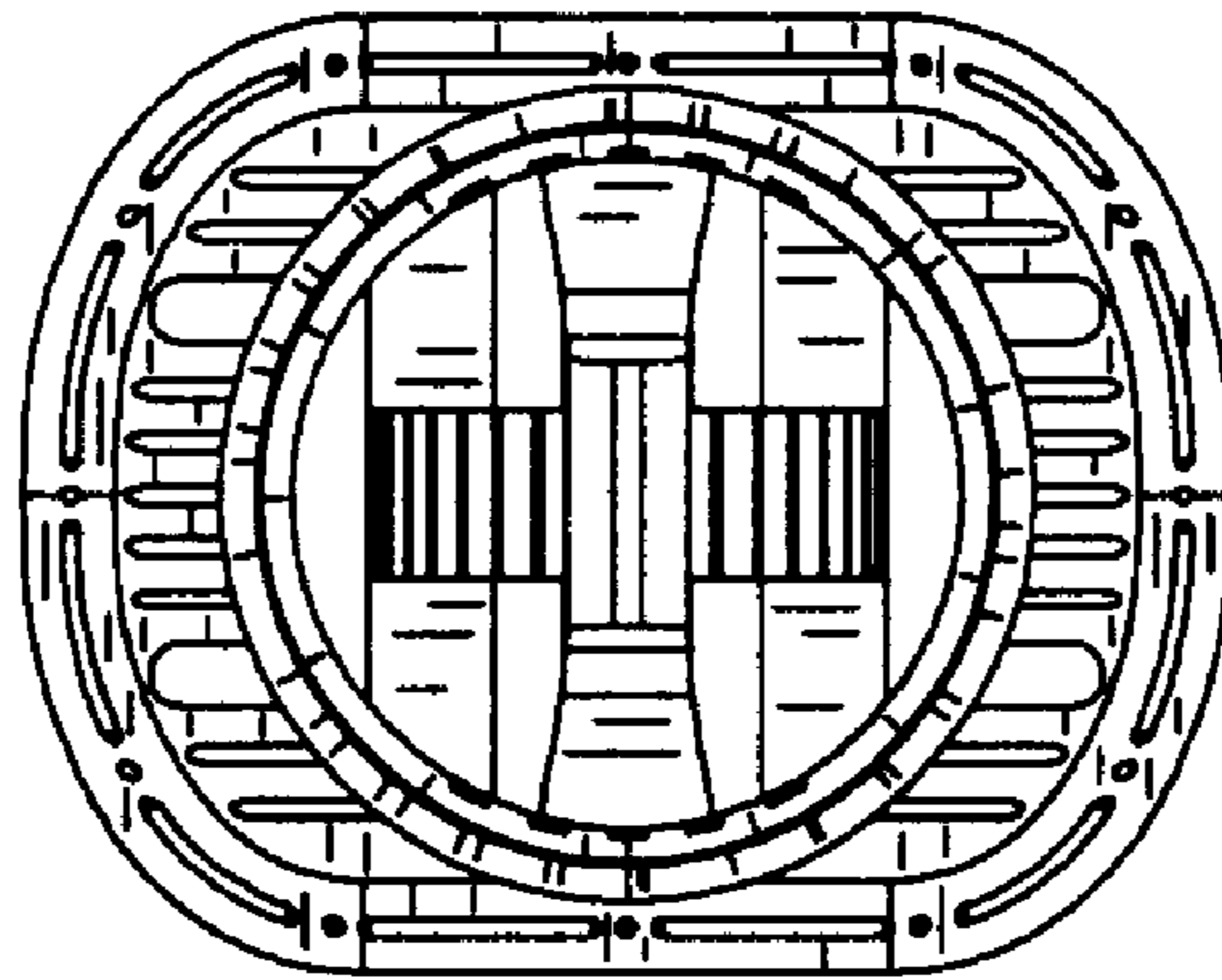

Fig. 5

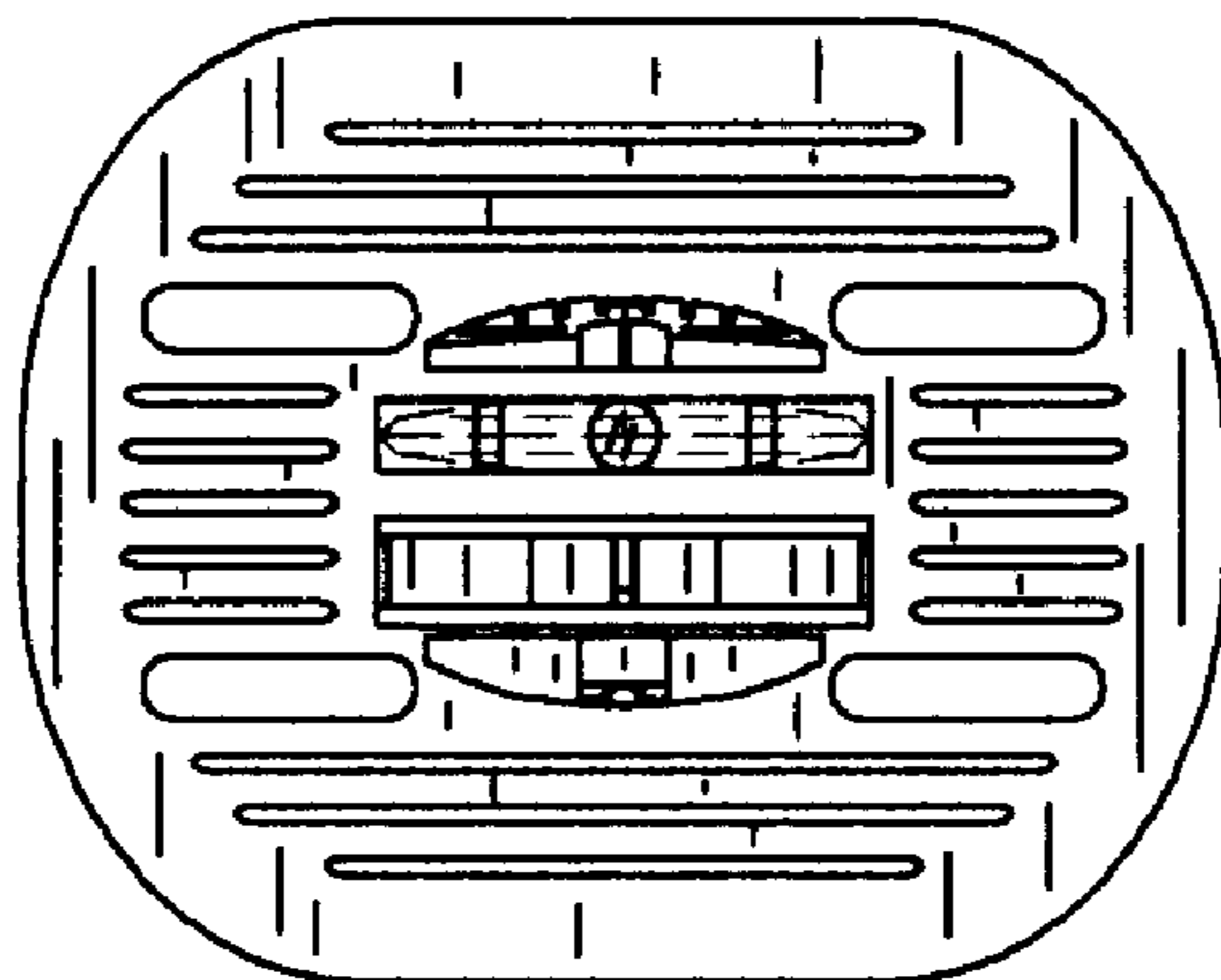

Fig. 6