

US00D513213S

(12) **United States Design Patent** (10) **Patent No.:** **US D513,213 S**
Sato (45) **Date of Patent:** **** Dec. 27, 2005**

(54) **AUTOMOBILE BUMPER**

(75) Inventor: **Jinichi Sato**, Tokyo (JP)

(73) Assignee: **Toyota Jidosha Kabushiki Kaisha**,
Aichi-ken (JP)

(**) Term: **14 Years**

(21) Appl. No.: **29/210,572**

(22) Filed: **Aug. 4, 2004**

(51) **LOC (6) Cl.** **12-16**

(52) **U.S. Cl.** **D12/169**

(58) **Field of Search** D12/90-92, 86,
D12/169, 196, 171; 296/180.1, 180.2; 293/102,
113, 115, 117, 120

(56) **References Cited**

U.S. PATENT DOCUMENTS

D462,640 S	9/2002	Sakae	
D473,167 S	4/2003	Shiono	
D473,168 S	4/2003	Hayashi	
D497,853 S	11/2004	Yanase	
D498,716 S	* 11/2004	Maeda et al.	D12/169
D503,133 S	* 3/2005	Pfeiffer et al.	D12/169
D503,134 S	* 3/2005	Pfeiffer et al.	D12/169

OTHER PUBLICATIONS

Hilux Surf, Brochure of Hilux Surf, Oct. 2002 (Mfg. Toyota Jidosha Kabushiki Kaisha.

* cited by examiner

Primary Examiner—Melody N. Brown
(74) *Attorney, Agent, or Firm*—Finnegan, Henderson, Farabow, Garrett & Dunner, LLP

(57) **CLAIM**

The ornamental design for an automobile bumper, as shown and described.

DESCRIPTION

FIG. 1 is a left-front, perspective view of an automobile bumper of my new design;

FIG. 2 is a front view of my new design;

FIG. 3 is a rear view of my new design;

FIG. 4 is a top view of my new design;

FIG. 5 is a bottom view of my new design;

FIG. 6 is a left-side view my new design, the right-side view being a mirror image thereof;

FIG. 7 is a cross-sectional view of my new design taken along the line 7—7 in FIG. 2, showing the profile of that portion of the design;

FIG. 8 is a cross-sectional view of my new design taken along the line 8—8 in FIG. 2, showing the profile of that portion of the design; and,

FIG. 9 is a cross-sectional view of my new design taken along the line 9—9 in FIG. 2, showing the profile of that portion of the design.

1 Claim, 8 Drawing Sheets

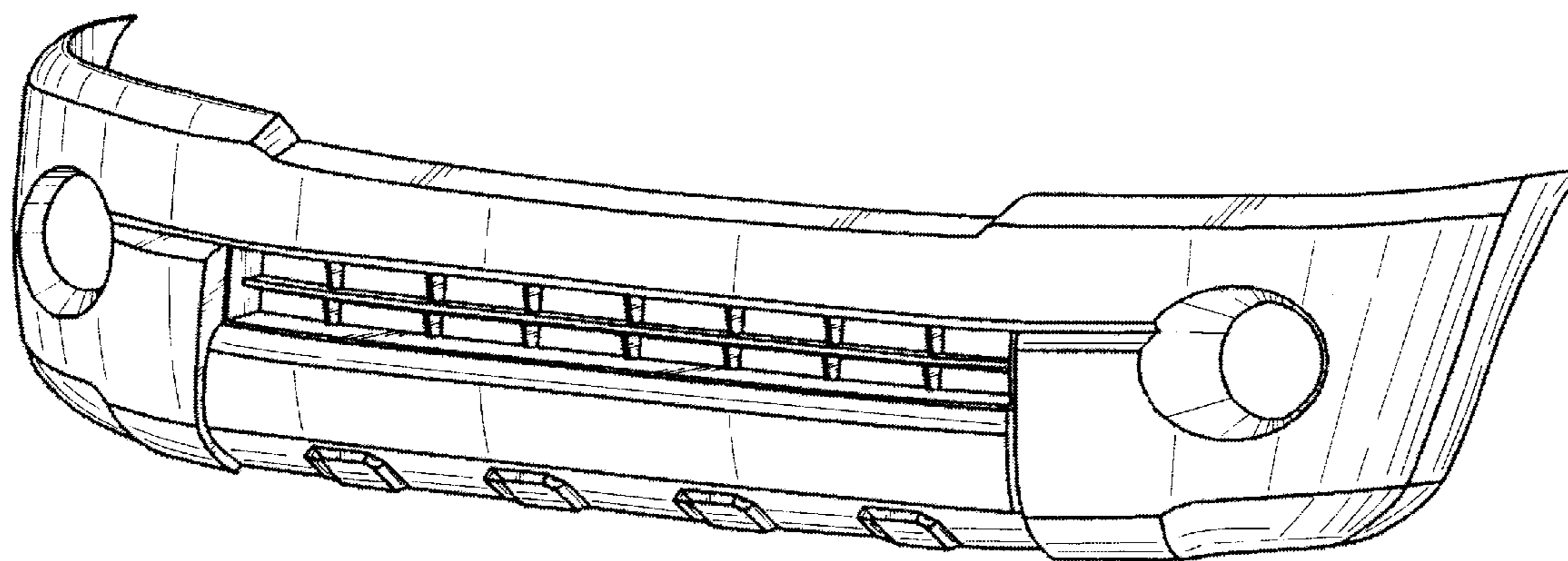

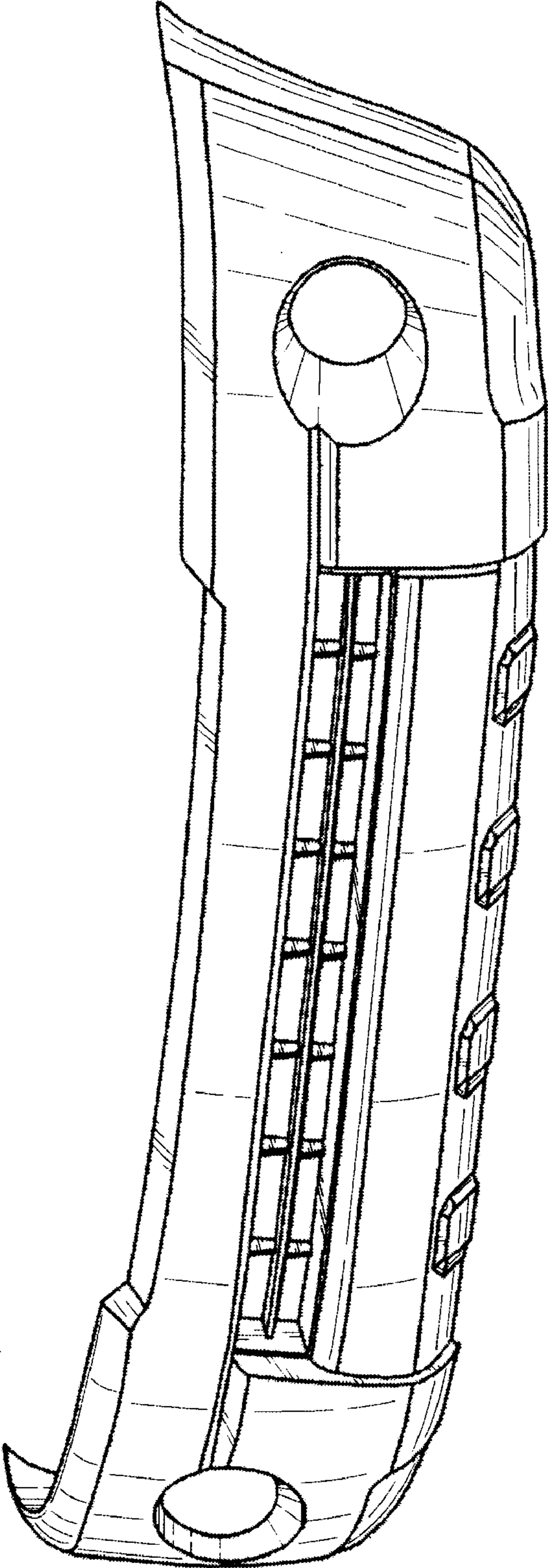

FIG. 1

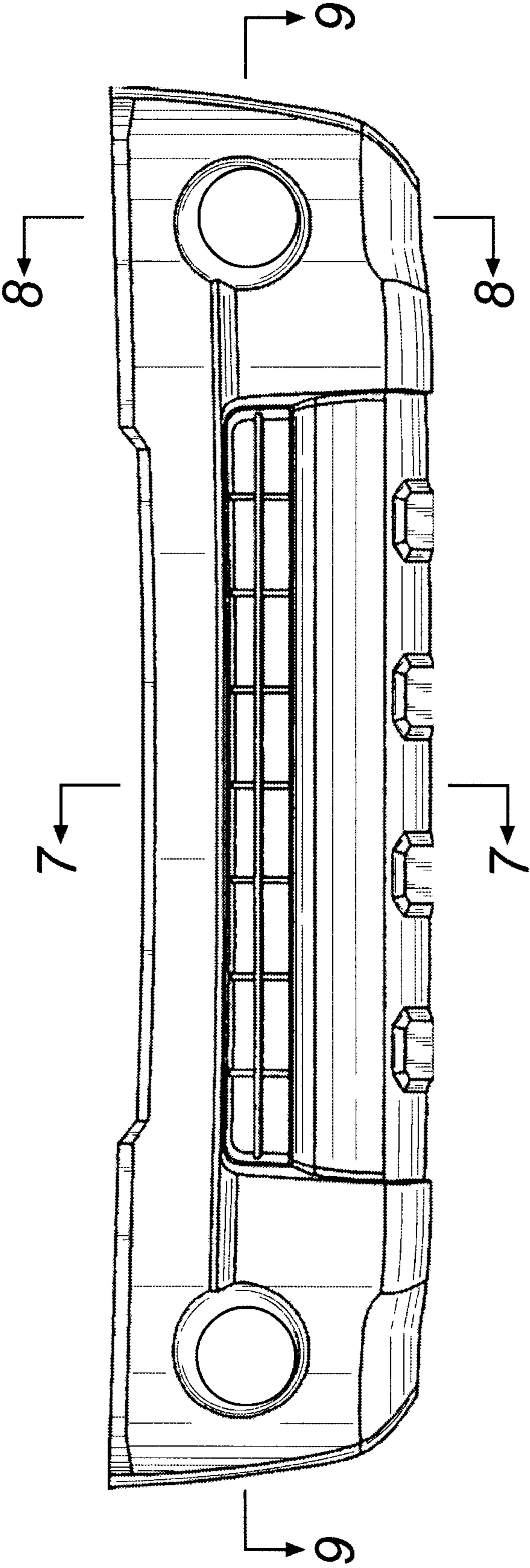

FIG. 2

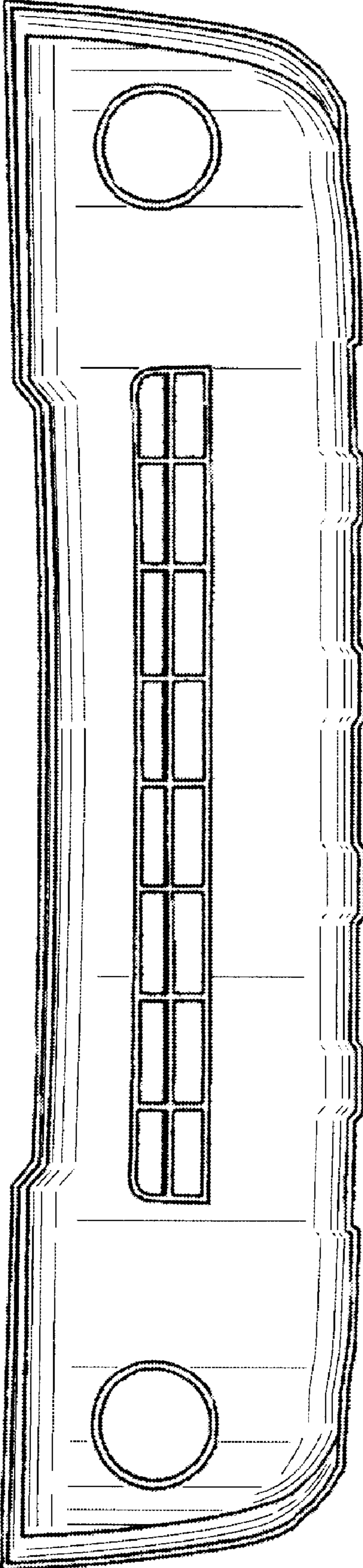

FIG. 3

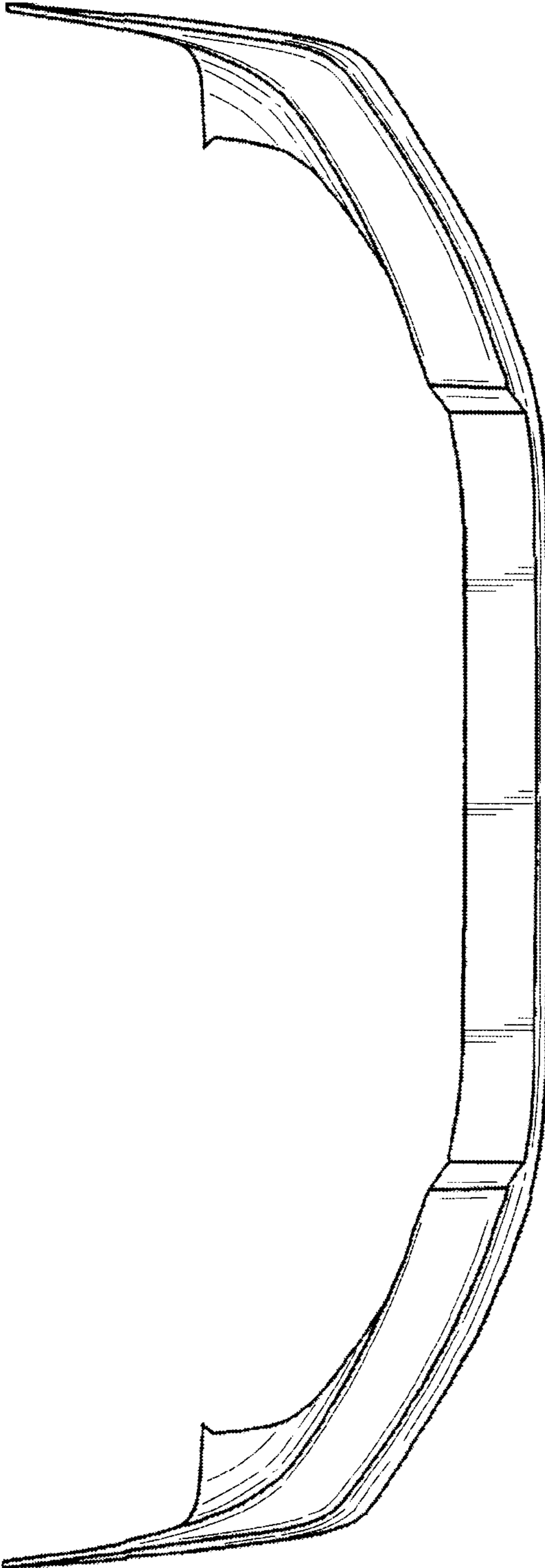

FIG. 4

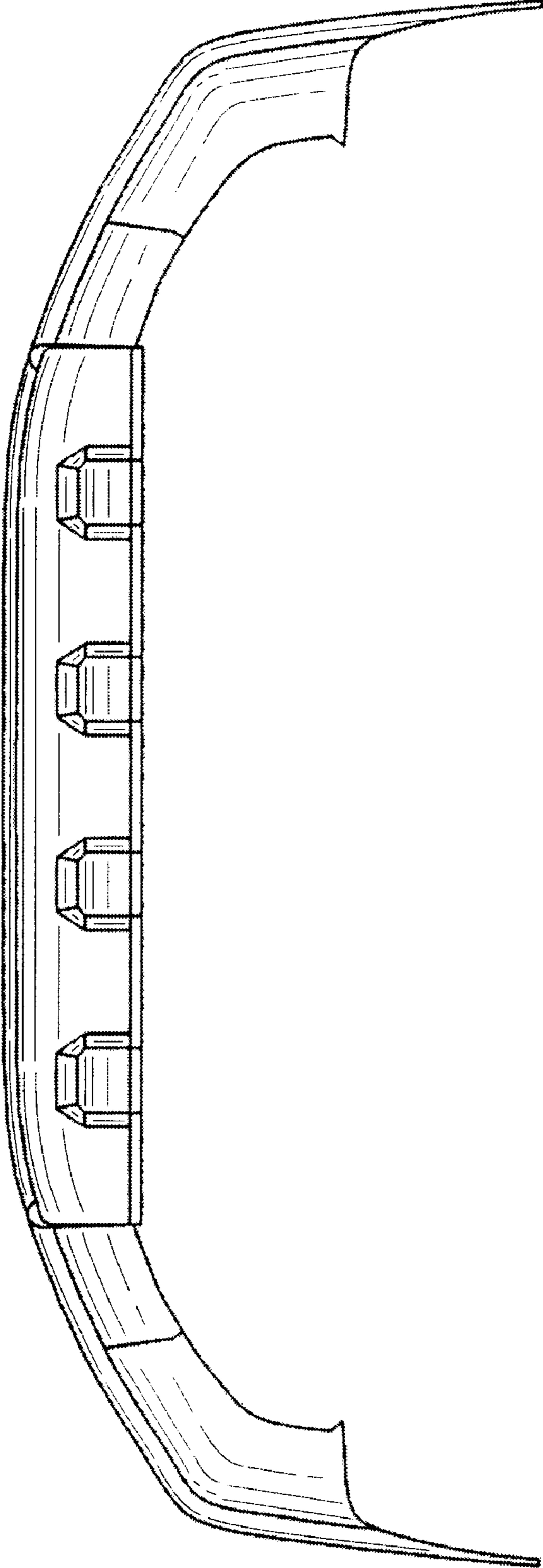

FIG. 5

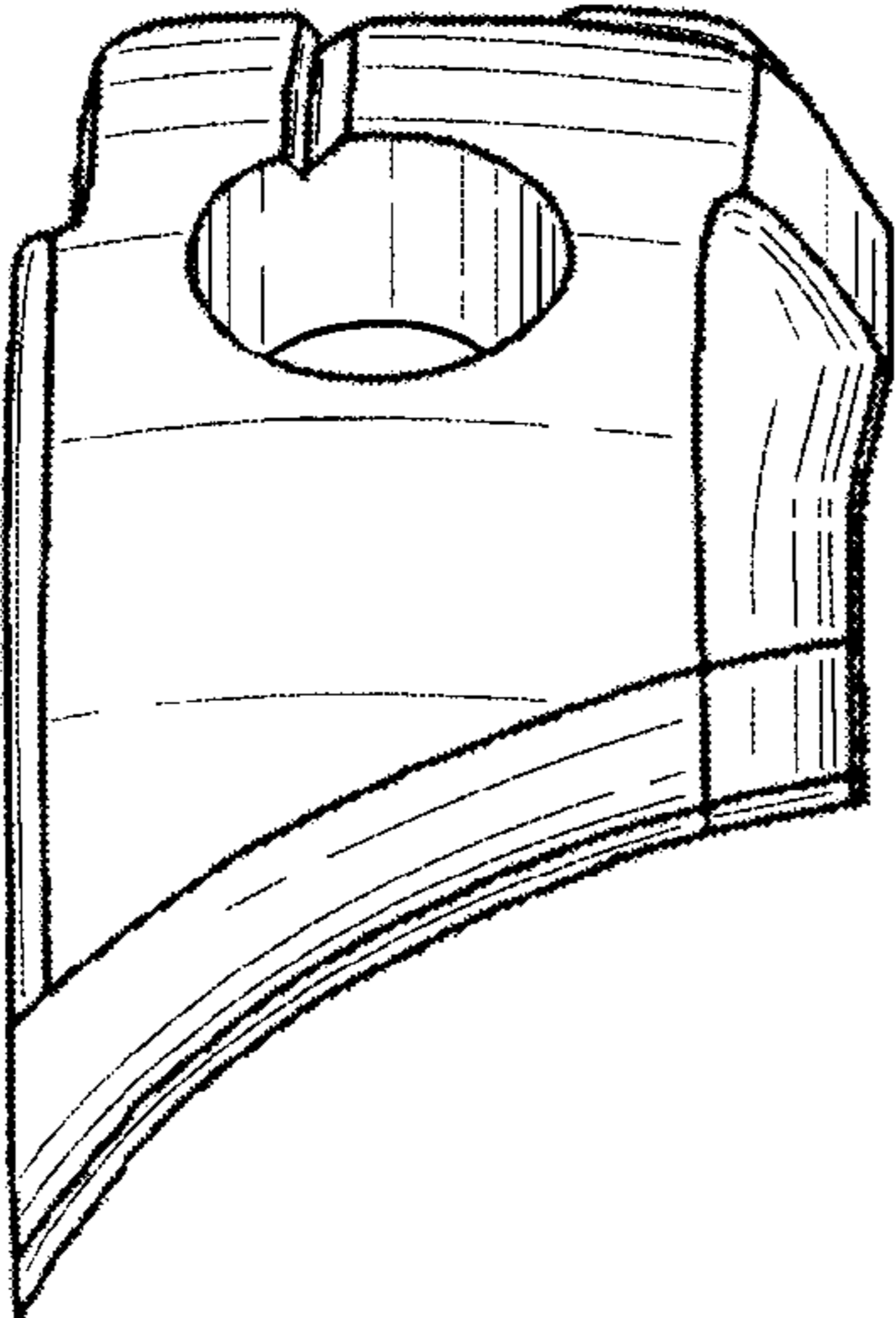

FIG. 6



FIG. 7



FIG. 8

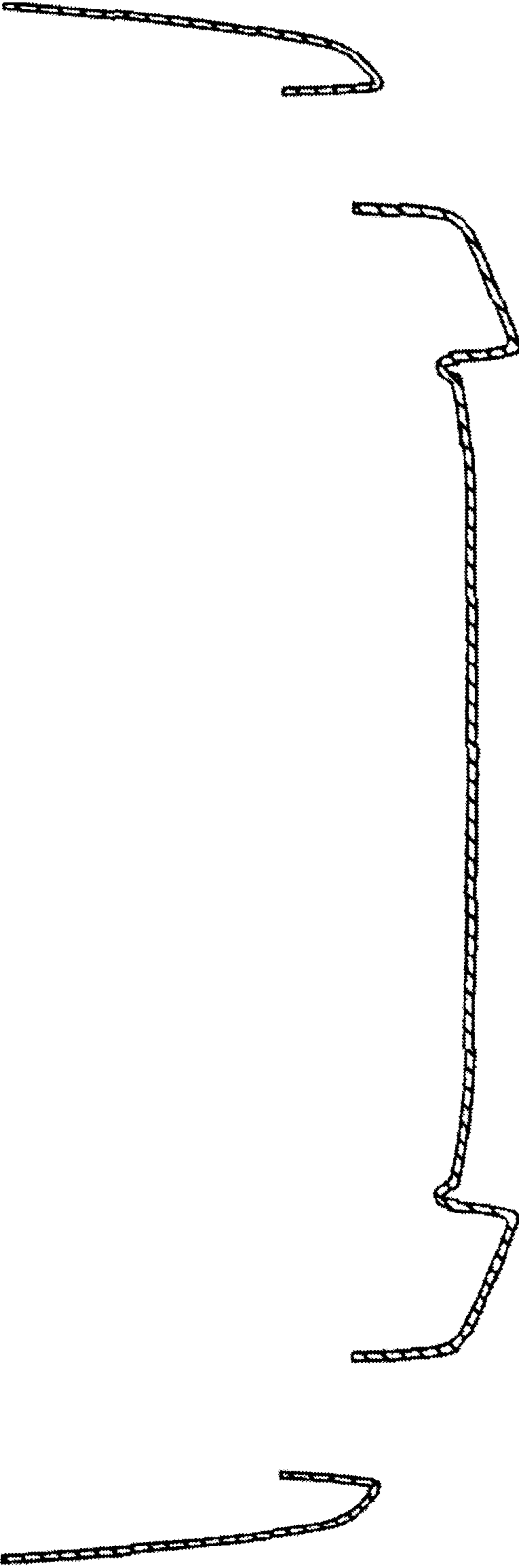

FIG. 9