



US00D513193S

(12) **United States Design Patent**  
**Heatherly et al.**

(10) **Patent No.:** **US D513,193 S**  
(45) **Date of Patent:** **\*\* Dec. 27, 2005**

(54) **ALARM CLOCK**

(75) Inventors: **Chris Heatherly**, Pasadena, CA (US);  
**Jon Guerra**, Pasadena, CA (US);  
**Matthew J Paprocki**, Los Angeles, CA  
(US); **Tylor H. Garland**, Los Angeles,  
CA (US)

(73) Assignee: **Disney Enterprises, Inc.**, Burbank, CA  
(US)

(\*\*) Term: **14 Years**

(21) Appl. No.: **29/204,849**

(22) Filed: **May 4, 2004**

(51) **LOC (6) Cl.** ..... **10-01**

(52) **U.S. Cl.** ..... **D10/6; D10/11; D10/15**

(58) **Field of Search** ..... D10/1-29, 33,  
D10/40, 128; 368/28-30, 41-44, 82-84,  
239-249, 276, 277, 280, 285, 88, 226,  
227, 223, 316, 317, 278, 284, 10

(56) **References Cited**

**U.S. PATENT DOCUMENTS**

D26,557 S \* 1/1897 Golden ..... D10/9

D83,625 S \* 3/1931 Castro ..... D10/11  
D93,646 S \* 10/1934 Bevier ..... D10/29  
D158,856 S \* 6/1950 Hiben ..... D10/11  
D210,740 S \* 4/1968 Appel et al. .... D10/8  
D210,742 S \* 4/1968 Appel et al. .... D10/8  
D444,073 S \* 6/2001 Liao ..... D10/11

\* cited by examiner

*Primary Examiner*—Lucy Lieberman

(74) *Attorney, Agent, or Firm*—Greenberg Traurig, LLP;  
Pablo E. Tapia, Esq.; Neer Gupta, Esq.

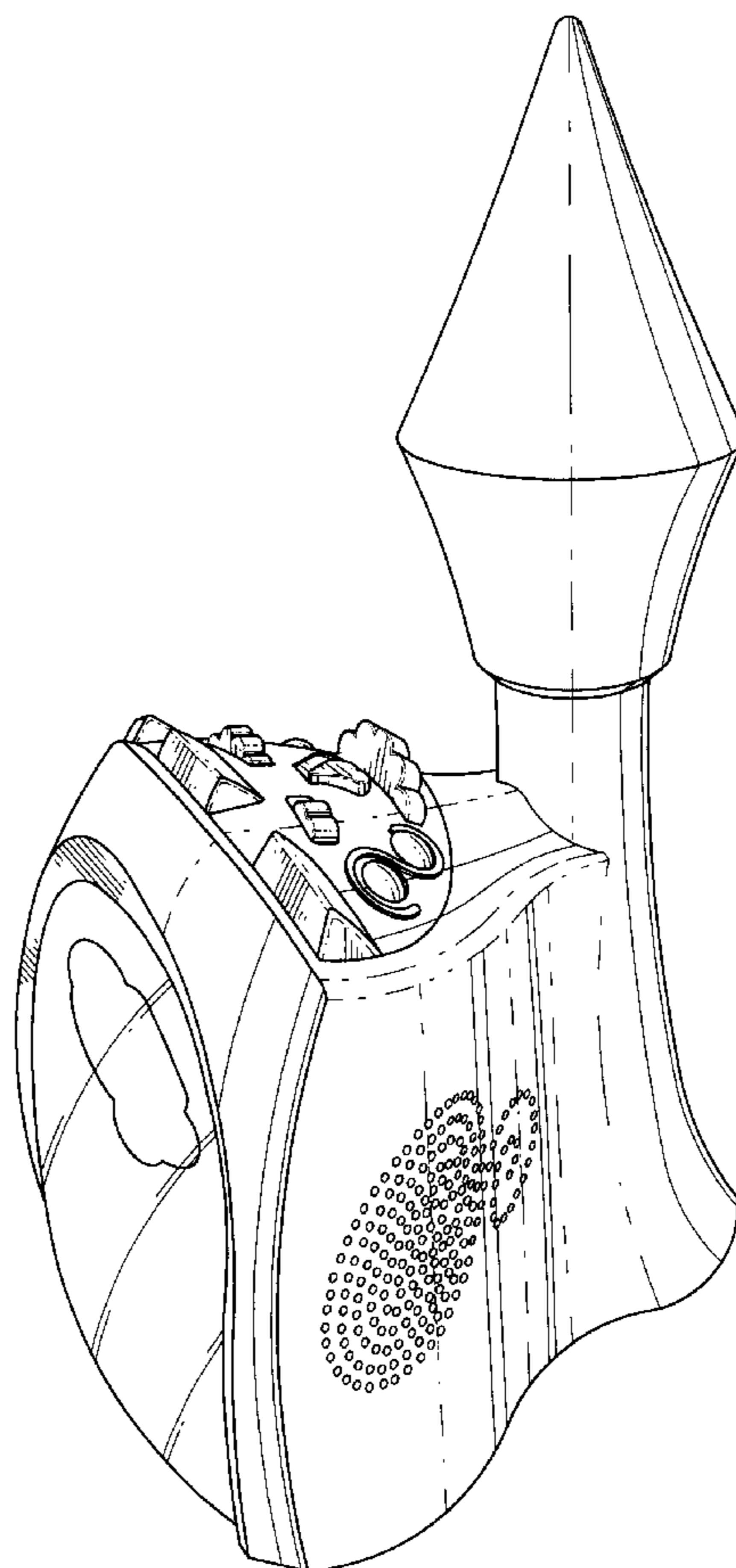
(57) **CLAIM**

The ornamental design for an alarm clock, as shown and  
described.

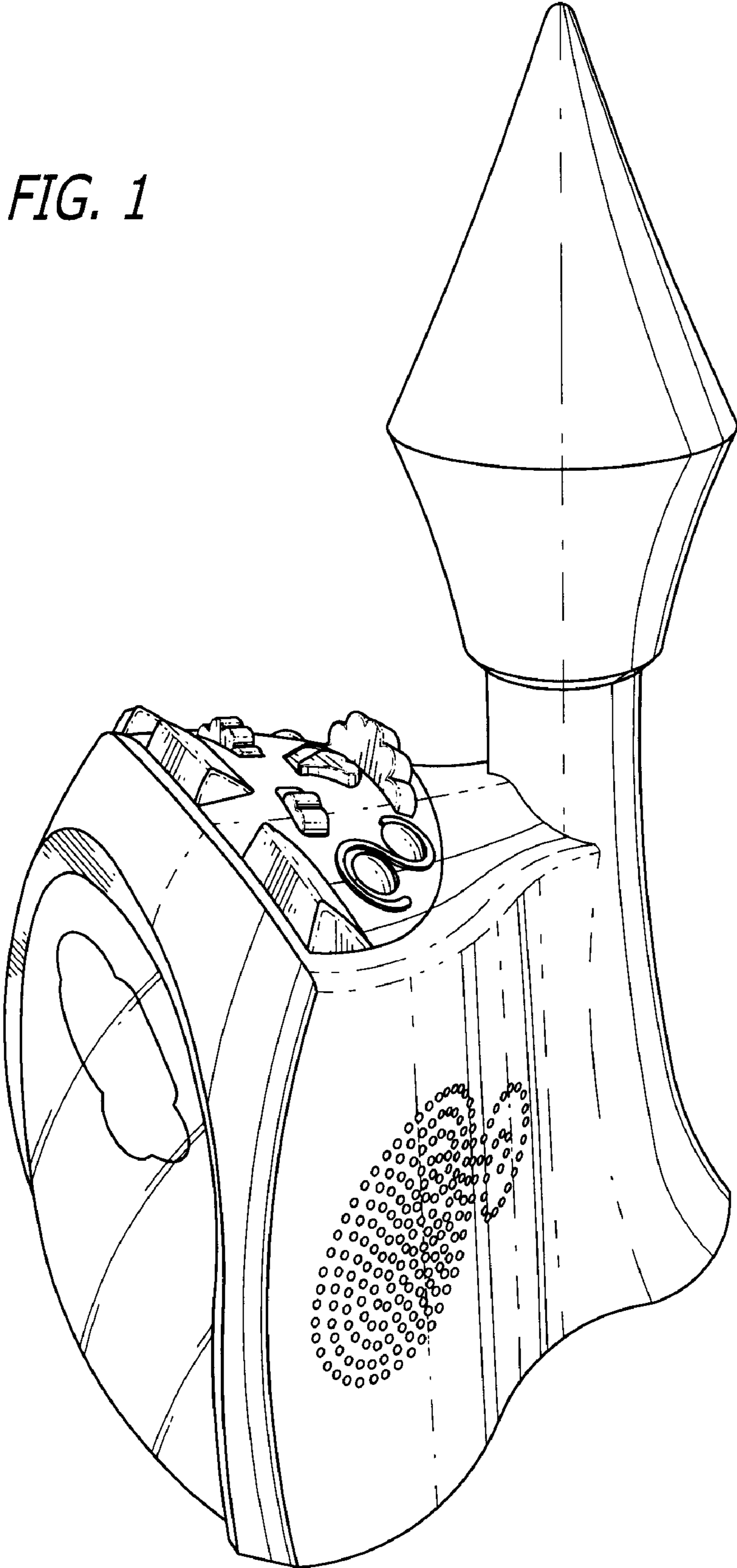
**DESCRIPTION**

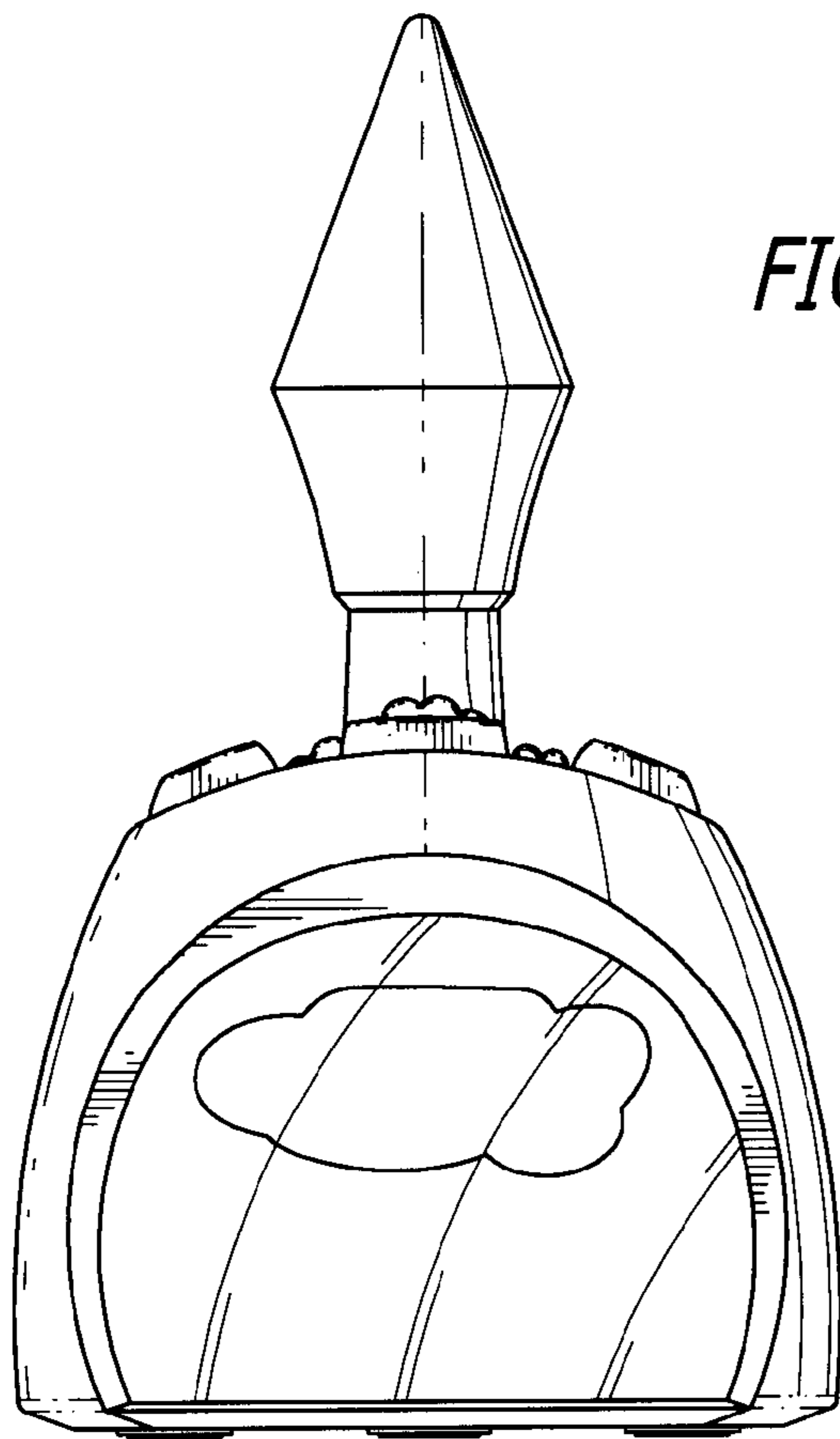
FIG. 1 is a perspective view of the design;  
FIG. 2 is a front view of the design;  
FIG. 3 is a back view of the design;  
FIG. 4 is a left side view of the design;  
FIG. 5 is a right side view of the design;  
FIG. 6 is a top plan view of the design; and,  
FIG. 7 is a bottom plan view of the alarm clock.

**1 Claim, 4 Drawing Sheets**

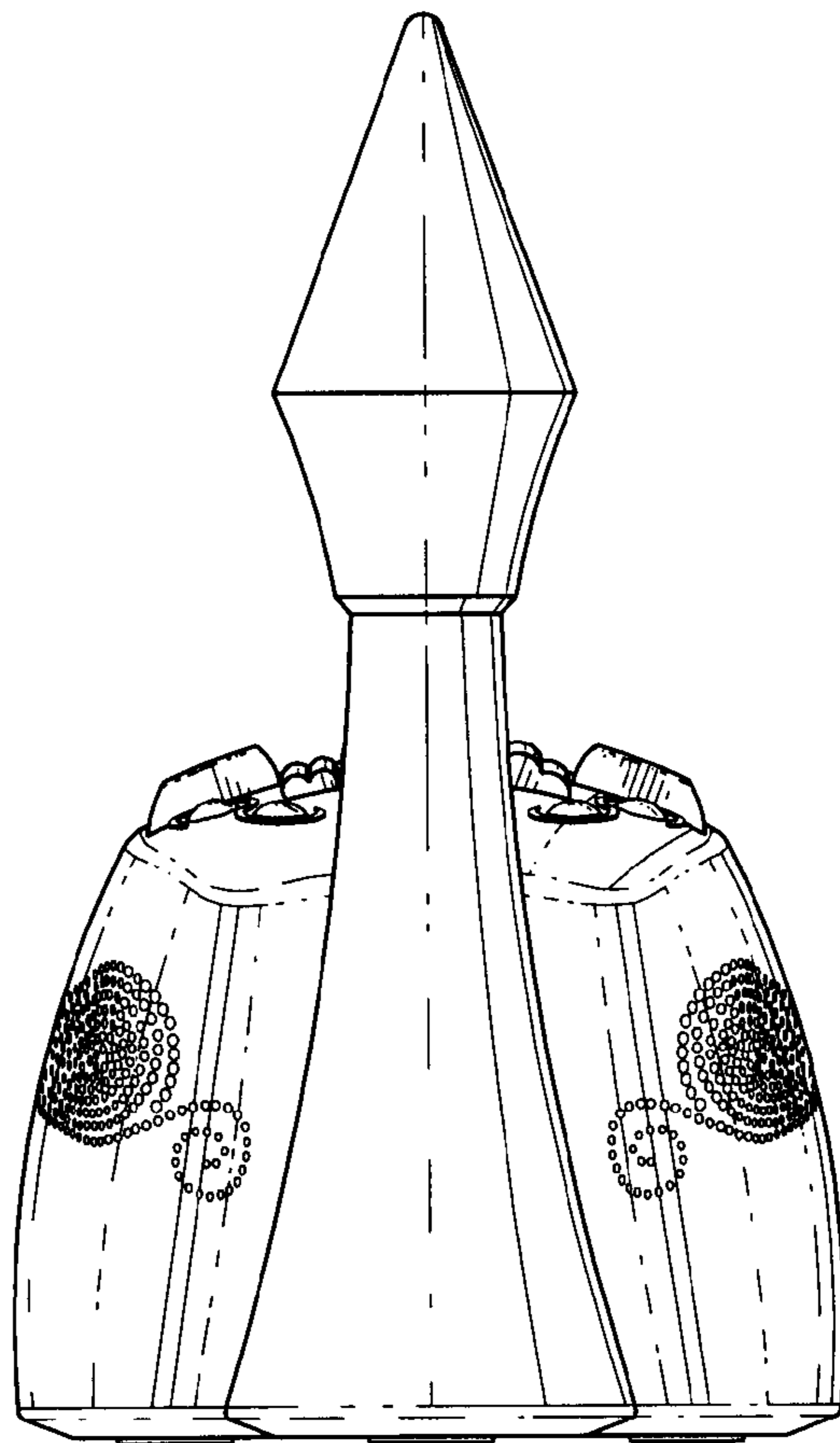


*FIG. 1*





*FIG. 2*



*FIG. 3*

FIG. 4

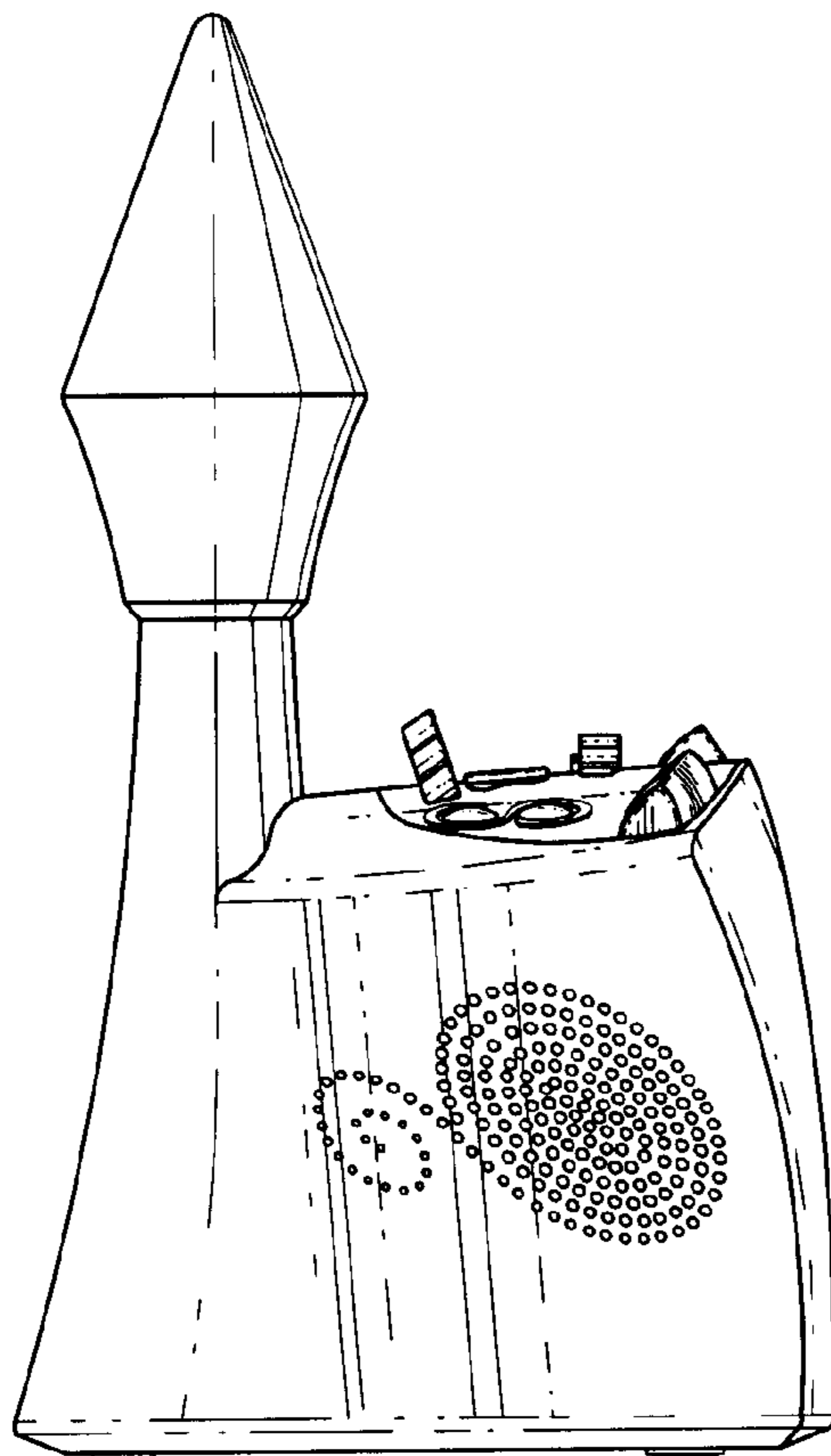
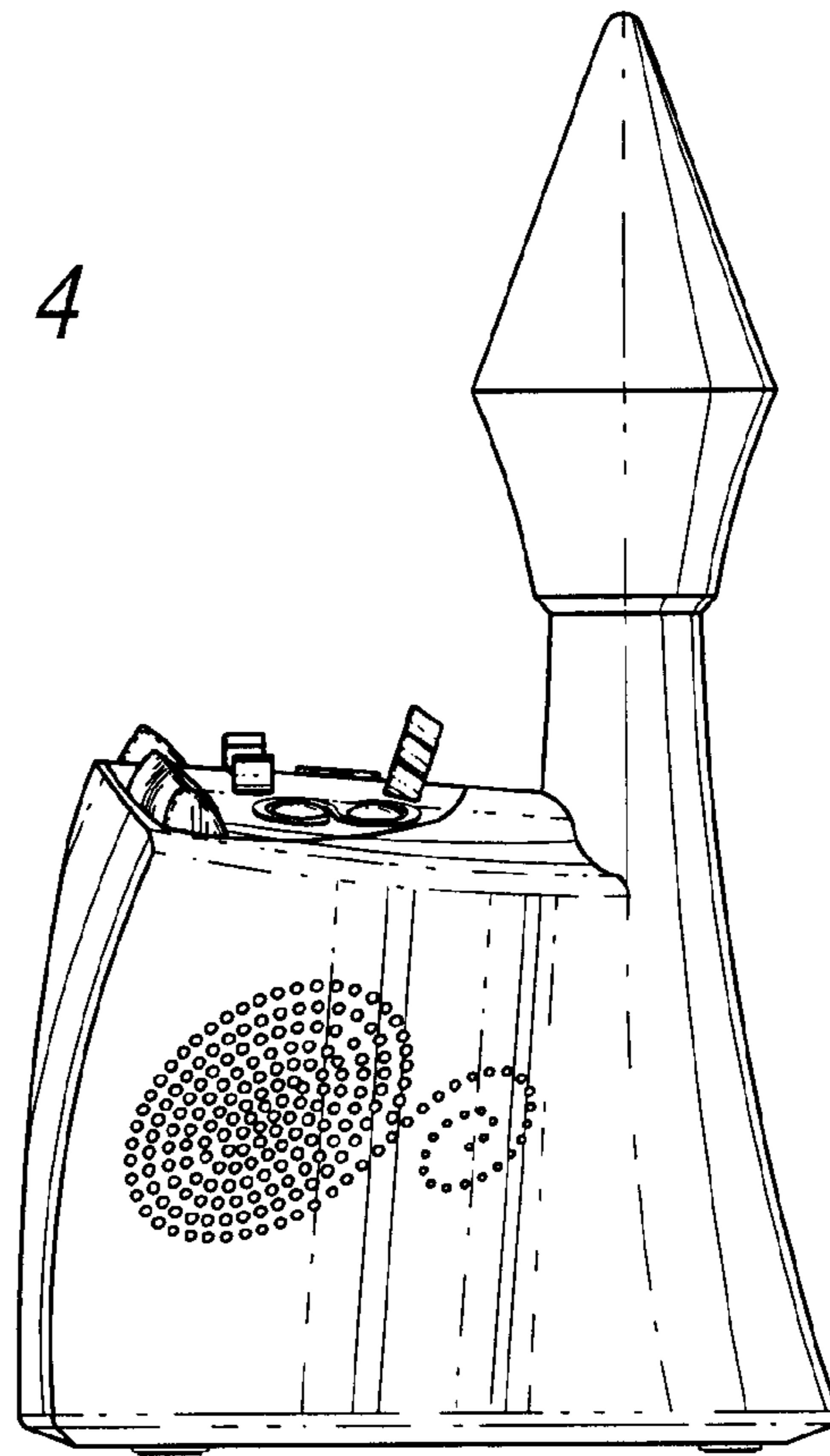
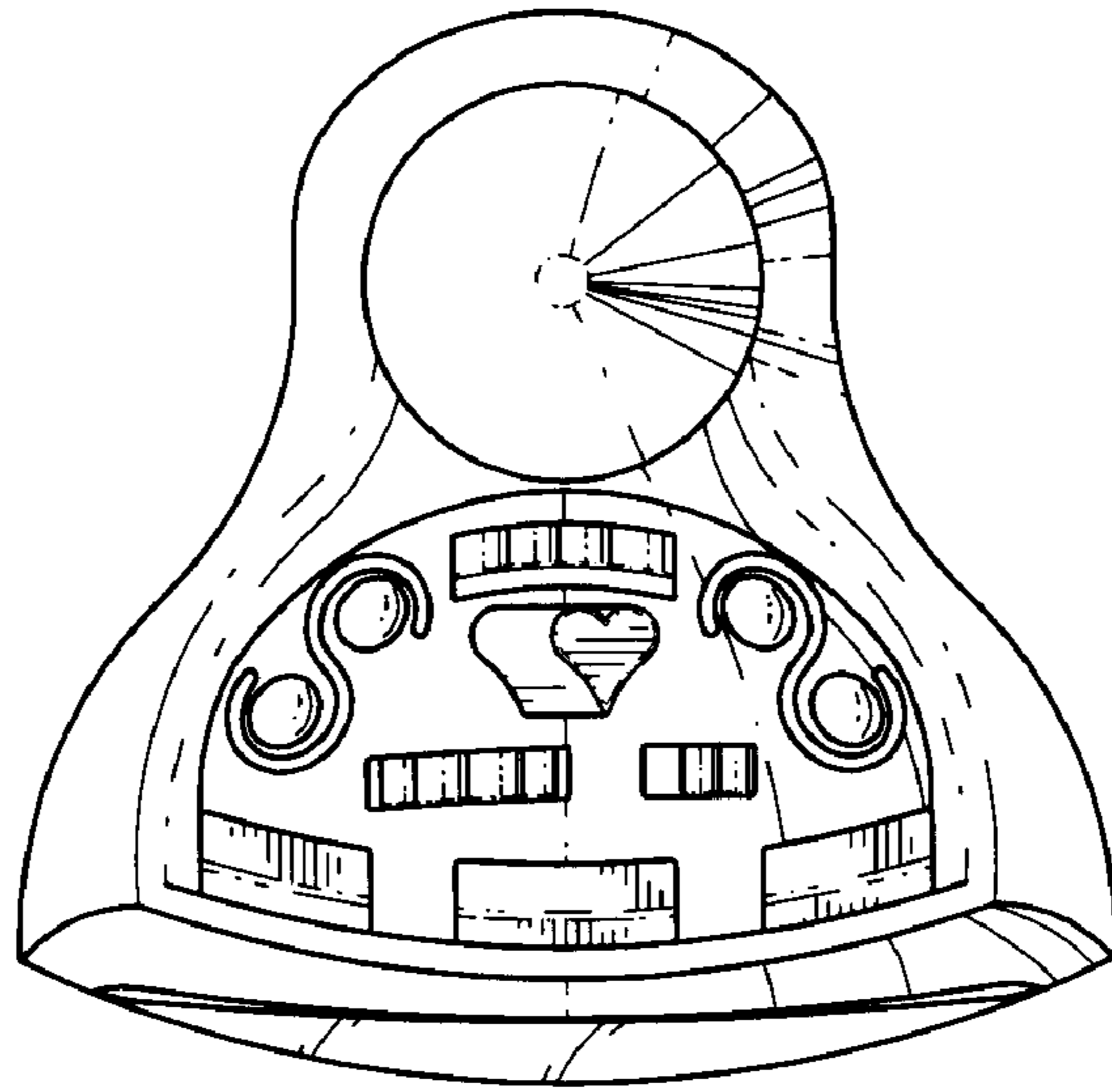
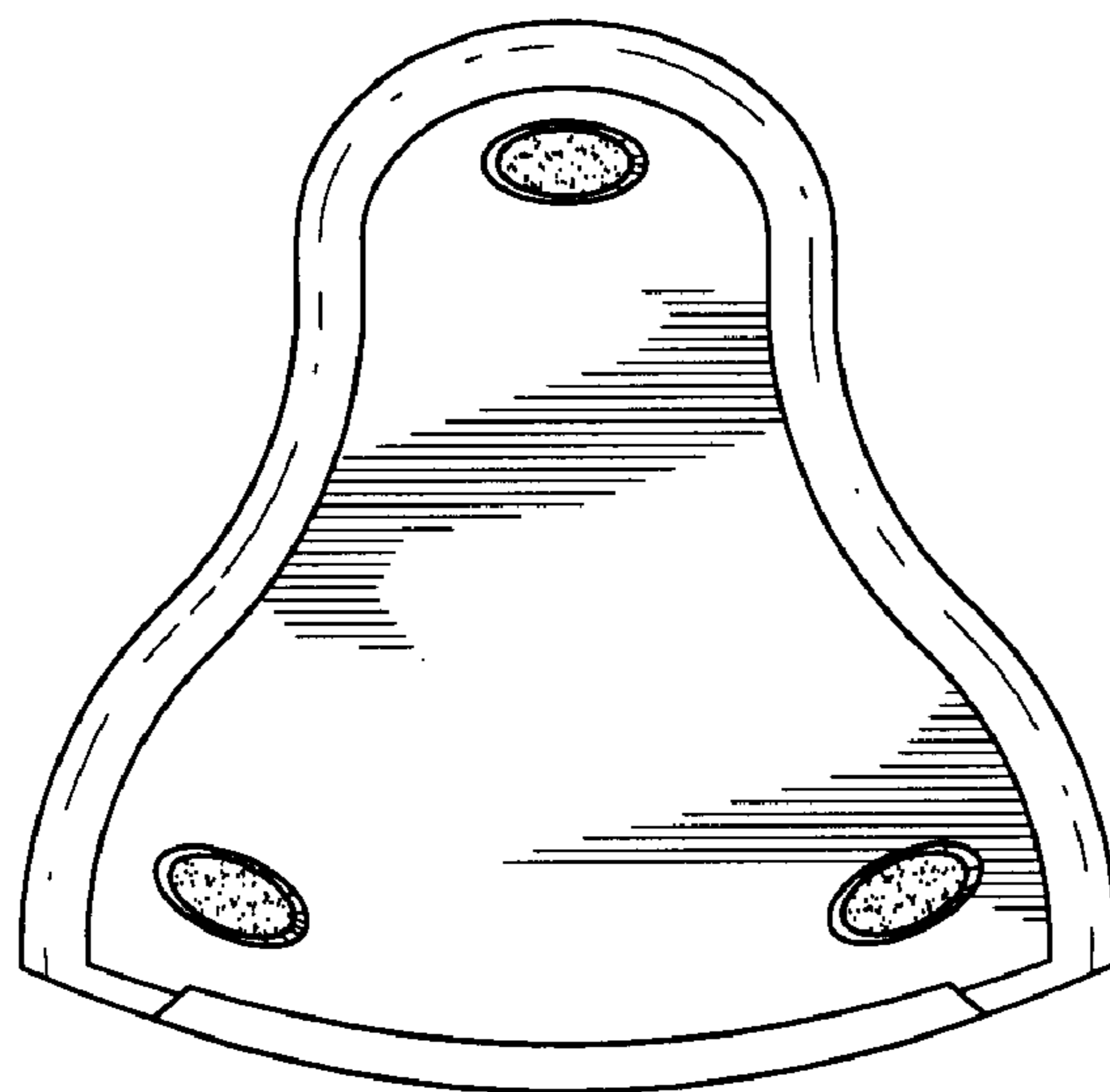


FIG. 5



*FIG. 6*



*FIG. 7*