



US00D513049S

(12) **United States Design Patent**  
**Hendrick**

(10) **Patent No.: US D513,049 S**

(45) **Date of Patent: \*\* Dec. 20, 2005**

(54) **GOLF PUTTER HEAD**

(76) Inventor: **Richard L. Hendrick**, 1907 York Ct.,  
Murfreesboro, TN (US) 37129

(\*\*) Term: **14 Years**

(21) Appl. No.: **29/205,974**

(22) Filed: **May 24, 2004**

(51) **LOC (6) Cl. .... 21-02**

(52) **U.S. Cl. .... D21/743**

(58) **Field of Search** ..... D21/736-746;  
473/324-331, 340, 341, 251-256, 313

(56) **References Cited**

**U.S. PATENT DOCUMENTS**

D357,519 S	*	4/1995	Ellickson et al. ....	D21/738
5,700,207 A	*	12/1997	Guthrie et al. ....	473/313
D486,540 S	*	2/2004	Bettinardi ....	D21/738
D486,541 S	*	2/2004	Bettinardi ....	D21/738
D500,539 S	*	1/2005	Holloway ....	D21/736

\* cited by examiner

*Primary Examiner*—Mitchell Siegel  
(74) *Attorney, Agent, or Firm*—Stites & Harbison, PLLC;  
Richard S. Myers, Jr.

(57) **CLAIM**

I claim the ornamental design for a golf putter head, as shown and described.

**DESCRIPTION**

The present invention relates to the ornamental design of a golf club, namely a putter that may be used to strike a golf ball.

FIG. 1 is a top plan view of a golf putter head showing the design of the present invention;

FIG. 2 is a bottom plan view thereof;

FIG. 3 is a front elevational view thereof;

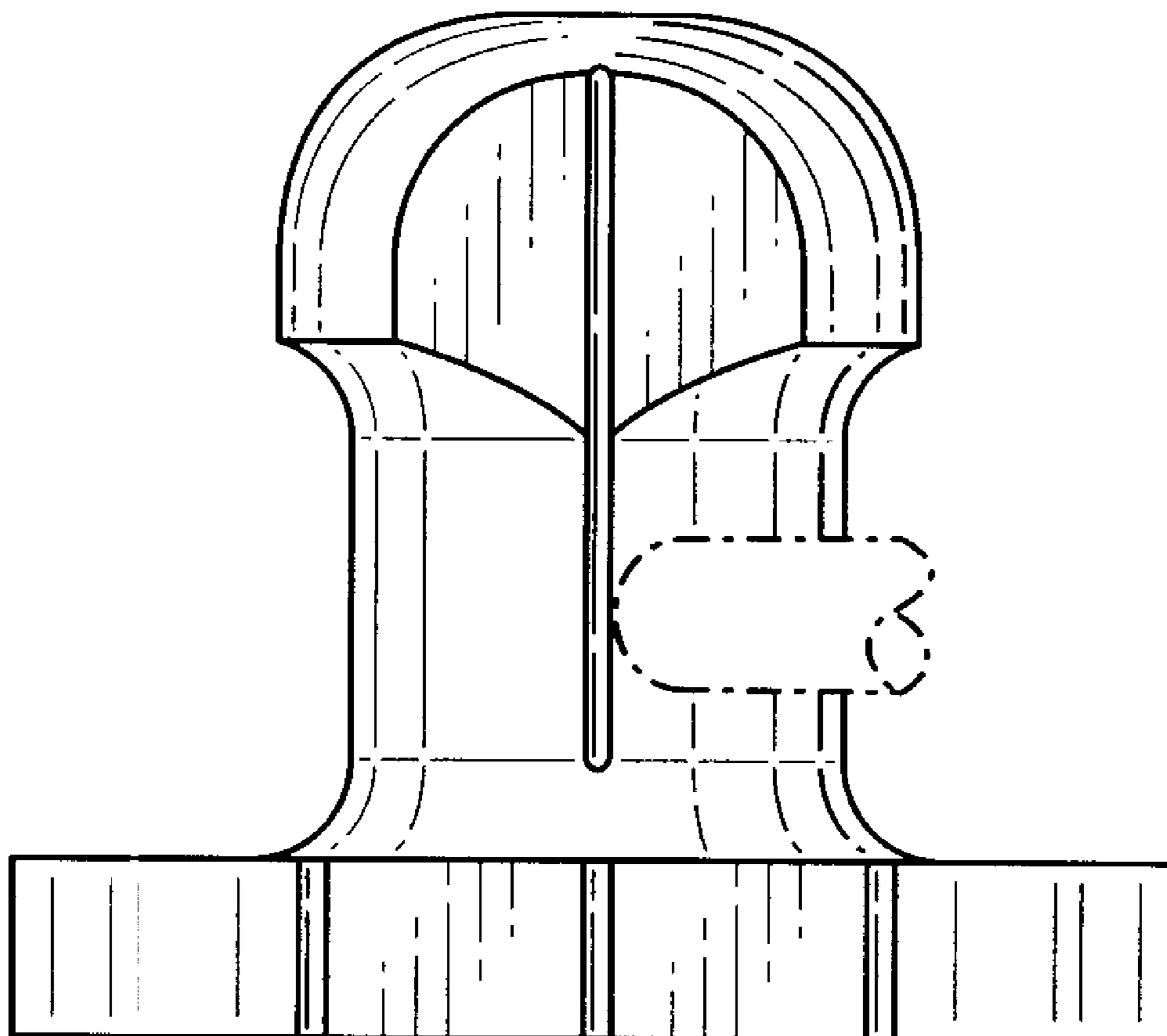
FIG. 4 is a side elevational view thereof;

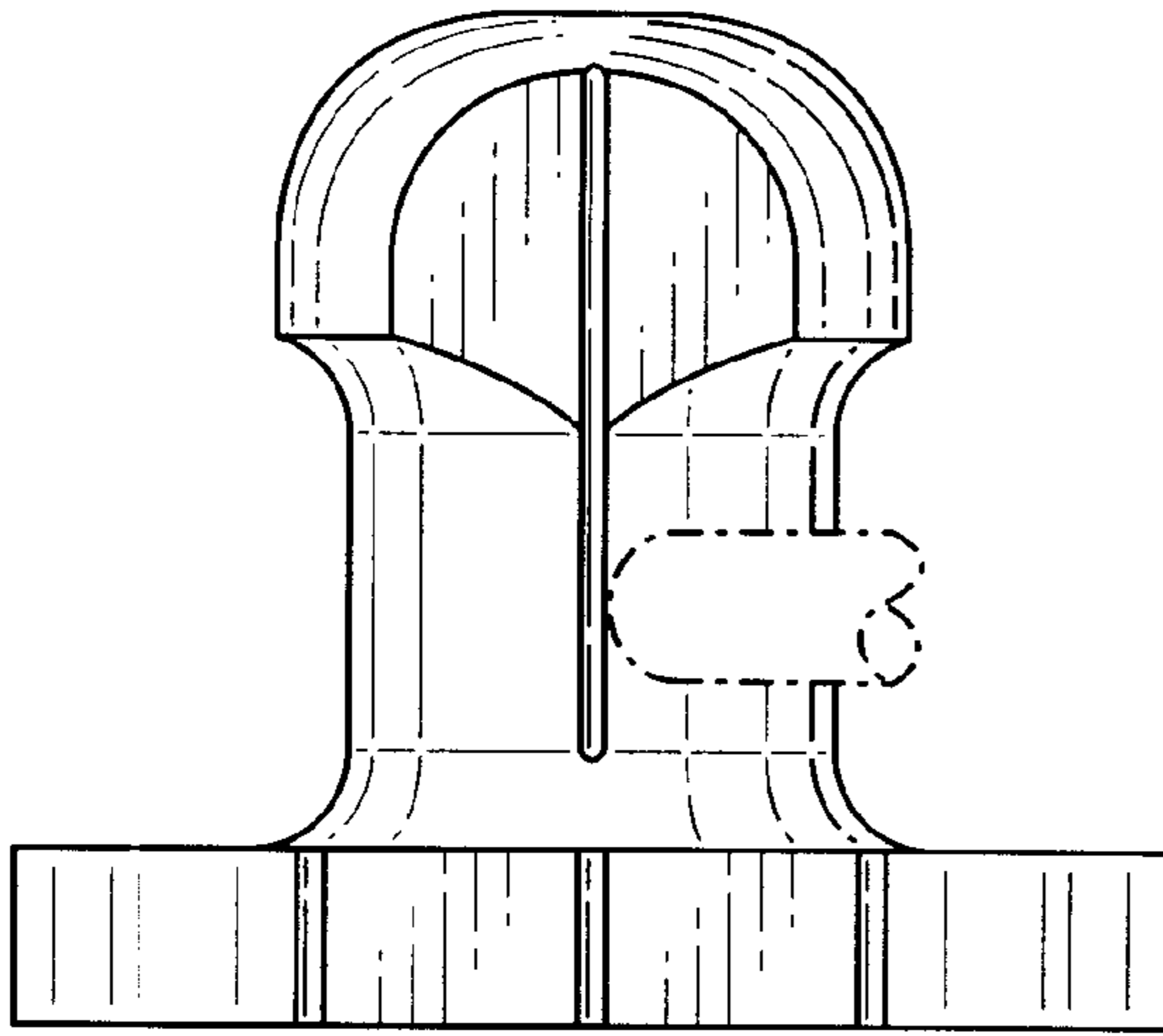
FIG. 5 is a rear elevational view thereof; and,

FIG. 6 is a side elevational view thereof.

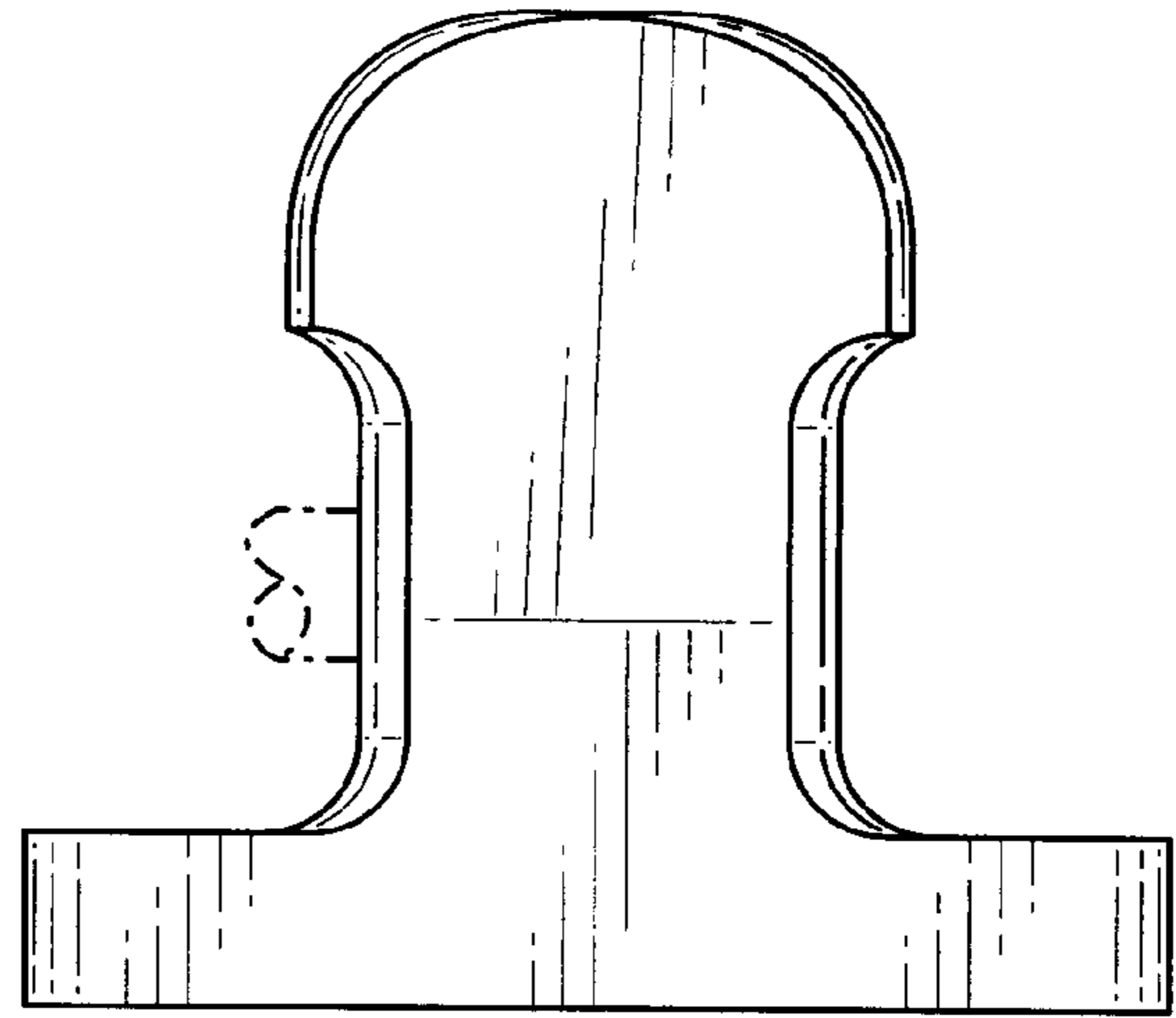
The broken line illustrates the golf putter shaft and is not part of the design sought to be patented.

**1 Claim, 1 Drawing Sheet**

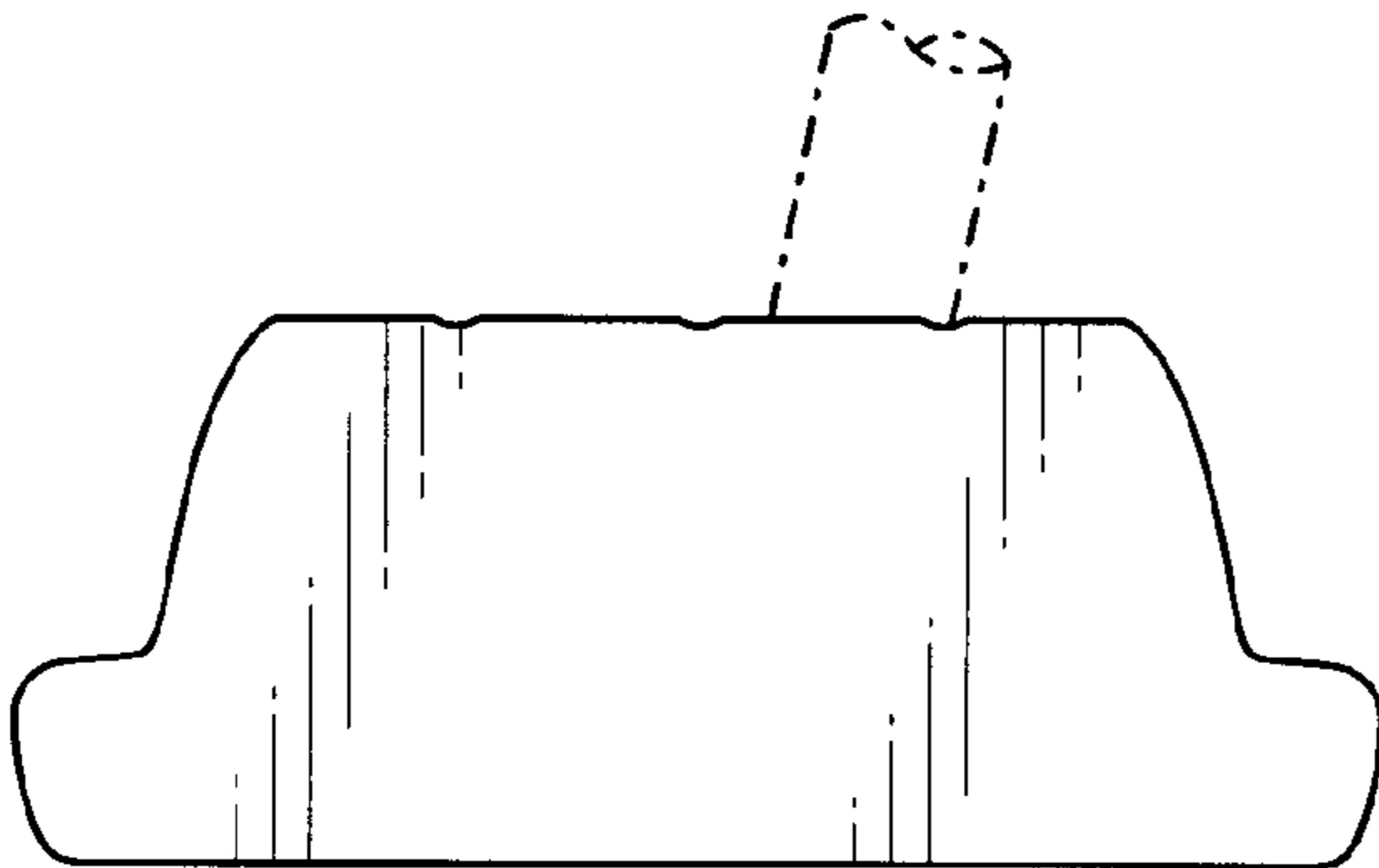




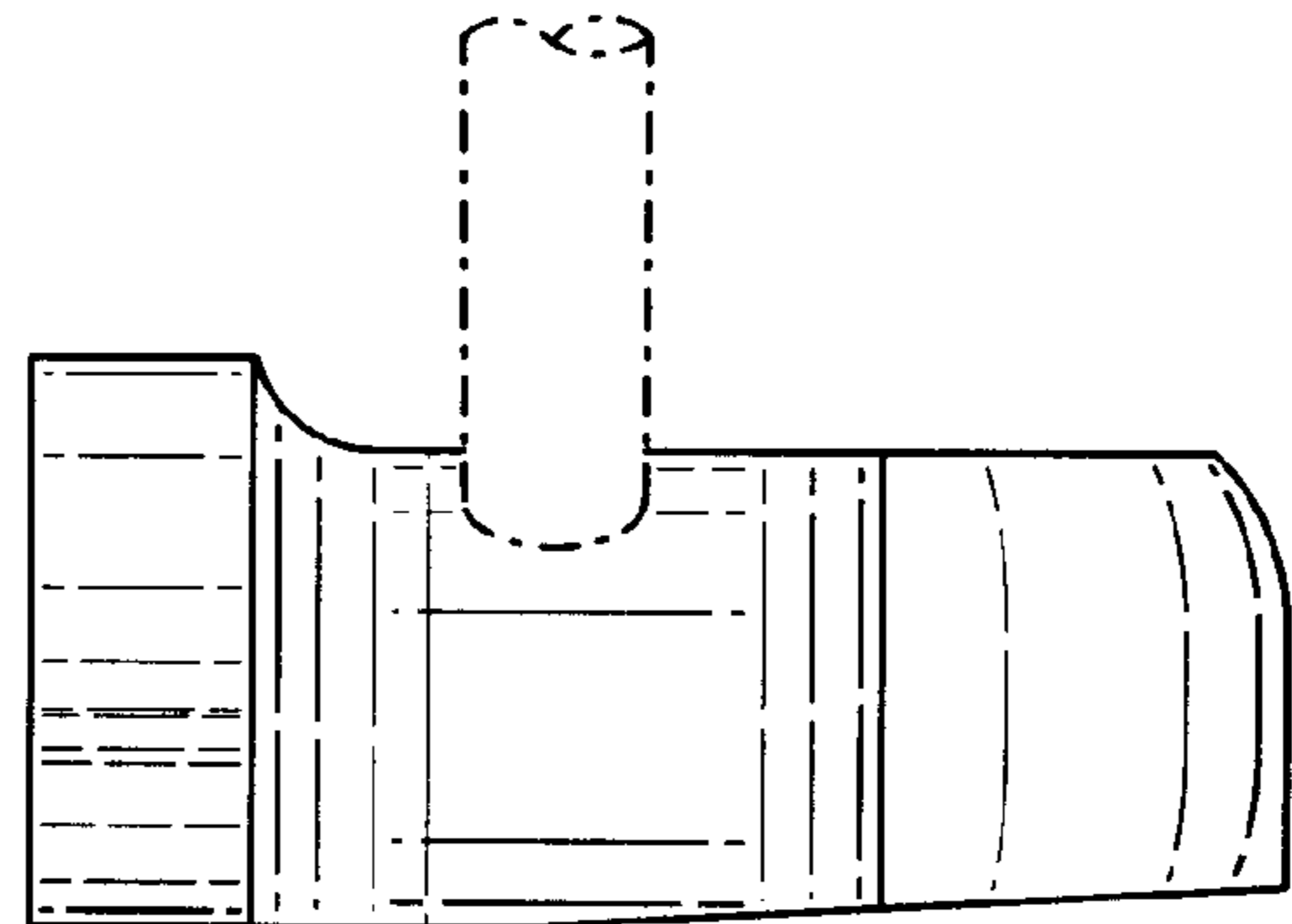
*FIG. 1*



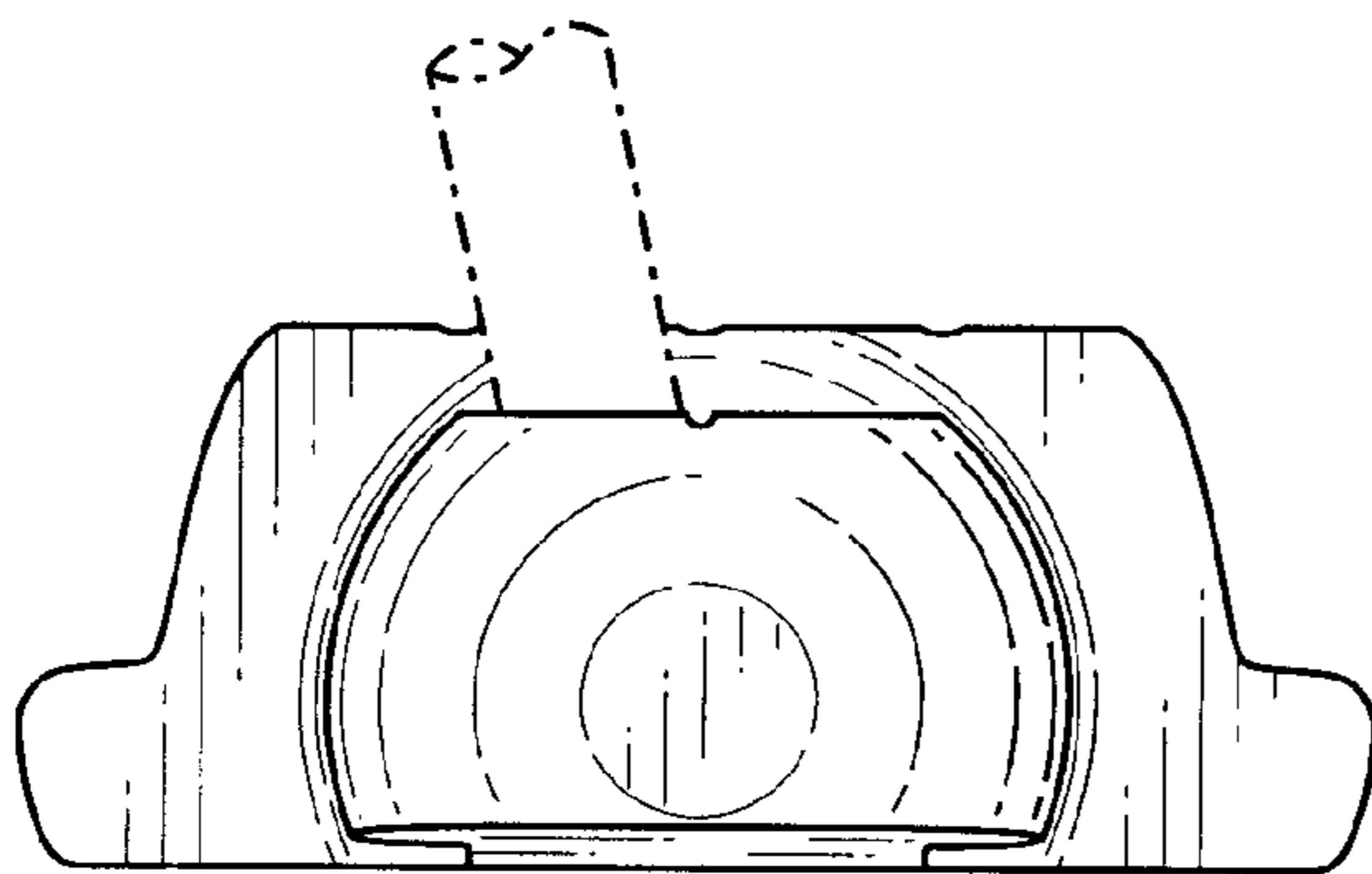
*FIG. 2*



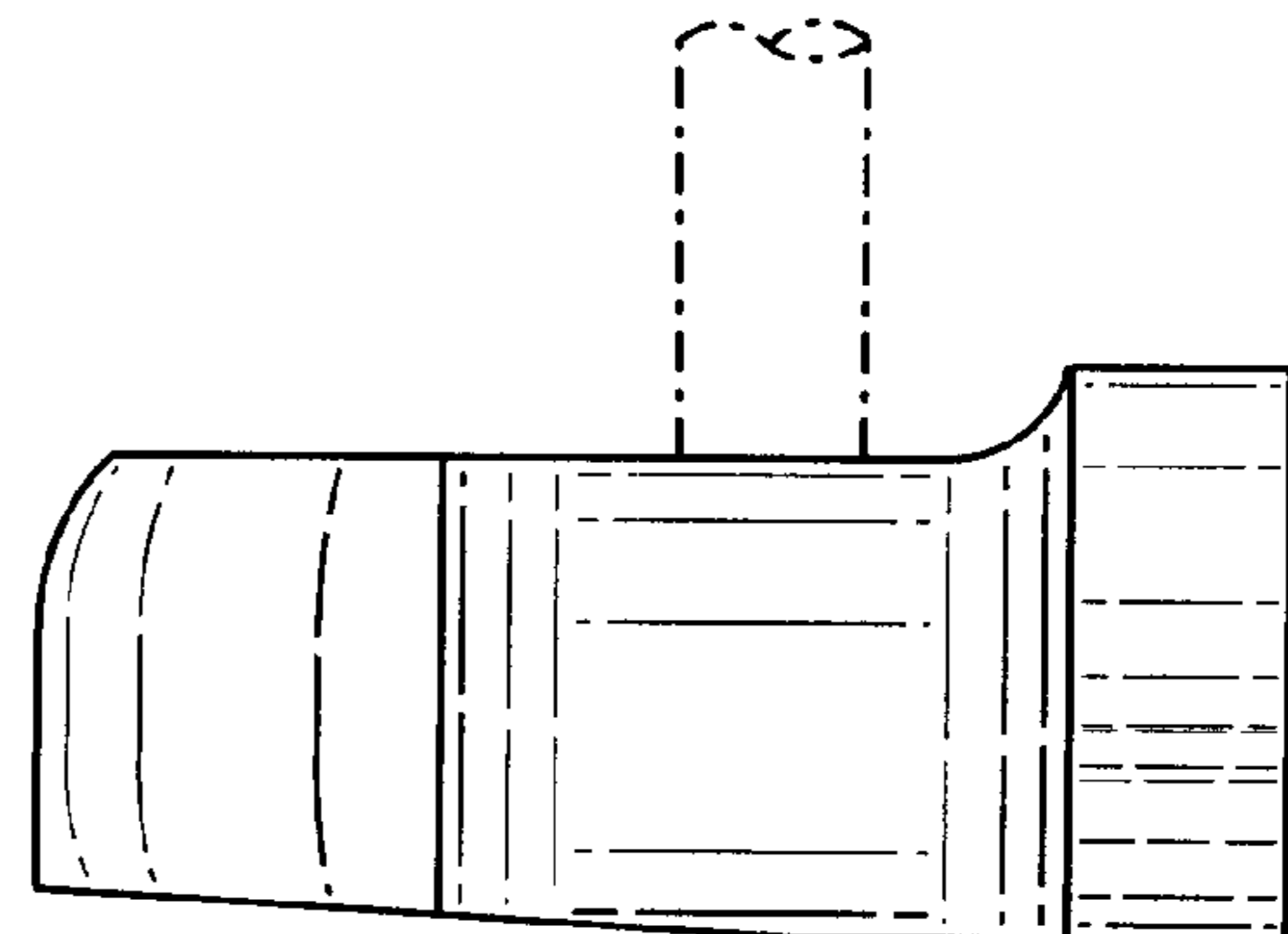
*FIG. 3*



*FIG. 4*



*FIG. 5*



*FIG. 6*