

US00D513010S

(12) **United States Design Patent** (10) **Patent No.:** **US D513,010 S**
Hussaini et al. (45) **Date of Patent:** **** *Dec. 20, 2005**

(54) **AUDIO AND VIDEO ACCESSORY FOR AN ELECTRONIC DEVICE**

6,466,436 B2 * 10/2002 Faranda et al. 361/685

* cited by examiner

(75) Inventors: **Saied Hussaini**, Miami, FL (US); **Marc Iacovelli**, Miami, FL (US)

Primary Examiner—Nanda Bondade
(74) *Attorney, Agent, or Firm*—Liniak, Berenato & White

(73) Assignee: **Intec, Inc.**, Miami, FL (US)

(57) **CLAIM**

(*) Notice: This patent is subject to a terminal disclaimer.

The ornamental design for an audio and video accessory for an electronic device, as shown and described.

(**) Term: **14 Years**

DESCRIPTION

(21) Appl. No.: **29/172,772**

FIG. 1 is a front view of the audio and video accessory for an electronic device according to the present invention.

(22) Filed: **Dec. 18, 2002**

FIG. 2 is a rear view of the audio and video accessory for an electronic device of FIG. 1.

(51) **LOC (6) Cl.** **14-01**

FIG. 3 is a left side view of the audio and video accessory for an electronic device of FIG. 1.

(52) **U.S. Cl.** **D14/496; D14/132**

FIG. 4 is a right side view of the audio and video accessory for an electronic device of FIG. 1.

(58) **Field of Search** D12/415–418,
D12/345; D14/125–136, 239, 315, 327,
371, 374–375, 451, 496; 296/37.1, 37.7–37.8,
70; 312/7.2; 340/461, 905, 995; 348/148,
825, 827, 836–838, 840

FIG. 5 is a top view of the audio and video accessory for an electronic device of FIG. 1.

FIG. 6 is a bottom view of the audio and video accessory for an electronic device of FIG. 1.

(56) **References Cited**

U.S. PATENT DOCUMENTS

5,519,572 A	*	5/1996	Luo	361/685
5,825,614 A	*	10/1998	Kim	361/663
D433,021 S	*	10/2000	Shibata	D14/356
6,144,746 A	*	11/2000	Azima et al.	381/152
D441,352 S	*	5/2001	Kuo	D14/217
D464,947 S	*	10/2002	Hussaini et al.	D14/217

FIG. 7 is a top view of the audio and video accessory for an electronic device of FIG. 1 with the display in a closed position; and,

FIG. 8 is a front and left perspective view of the audio and video accessory of an electronic device of FIG. 1.

The broken lines showing of the control knobs, audio/video ports and speaker grills are for illustrative purposes only and forms no part of the claimed design.

1 Claim, 7 Drawing Sheets

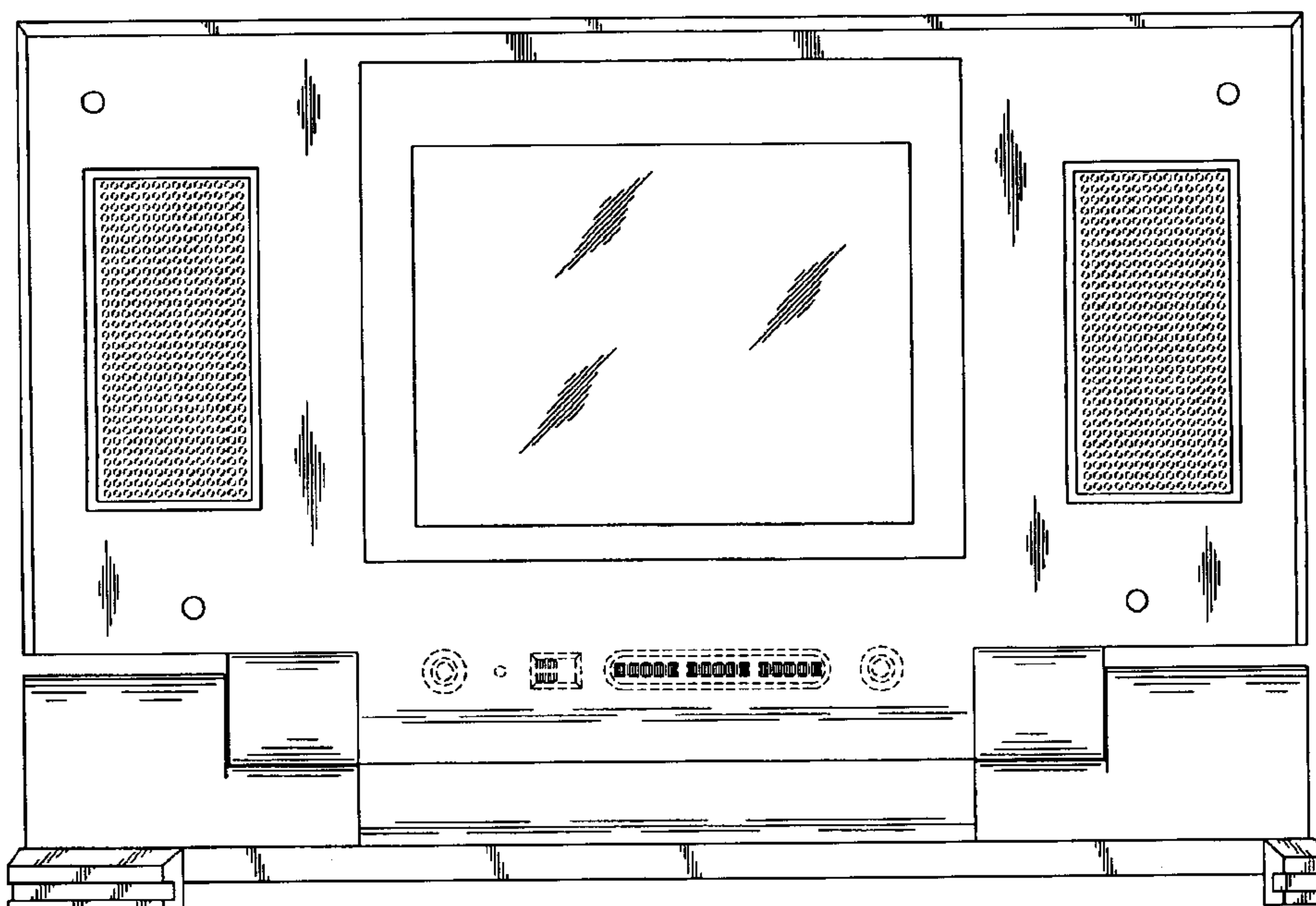

Fig. 1

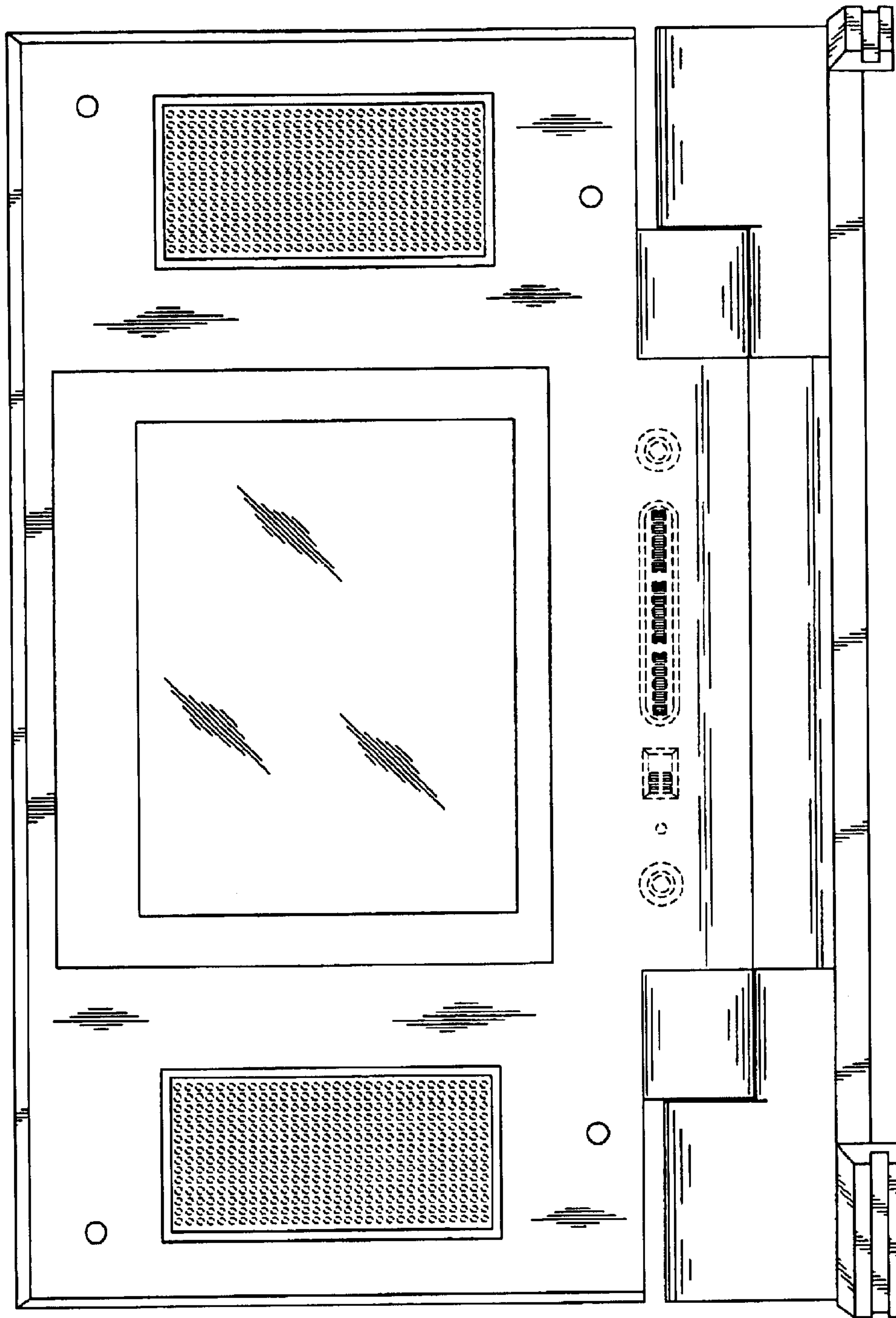

Fig. 2

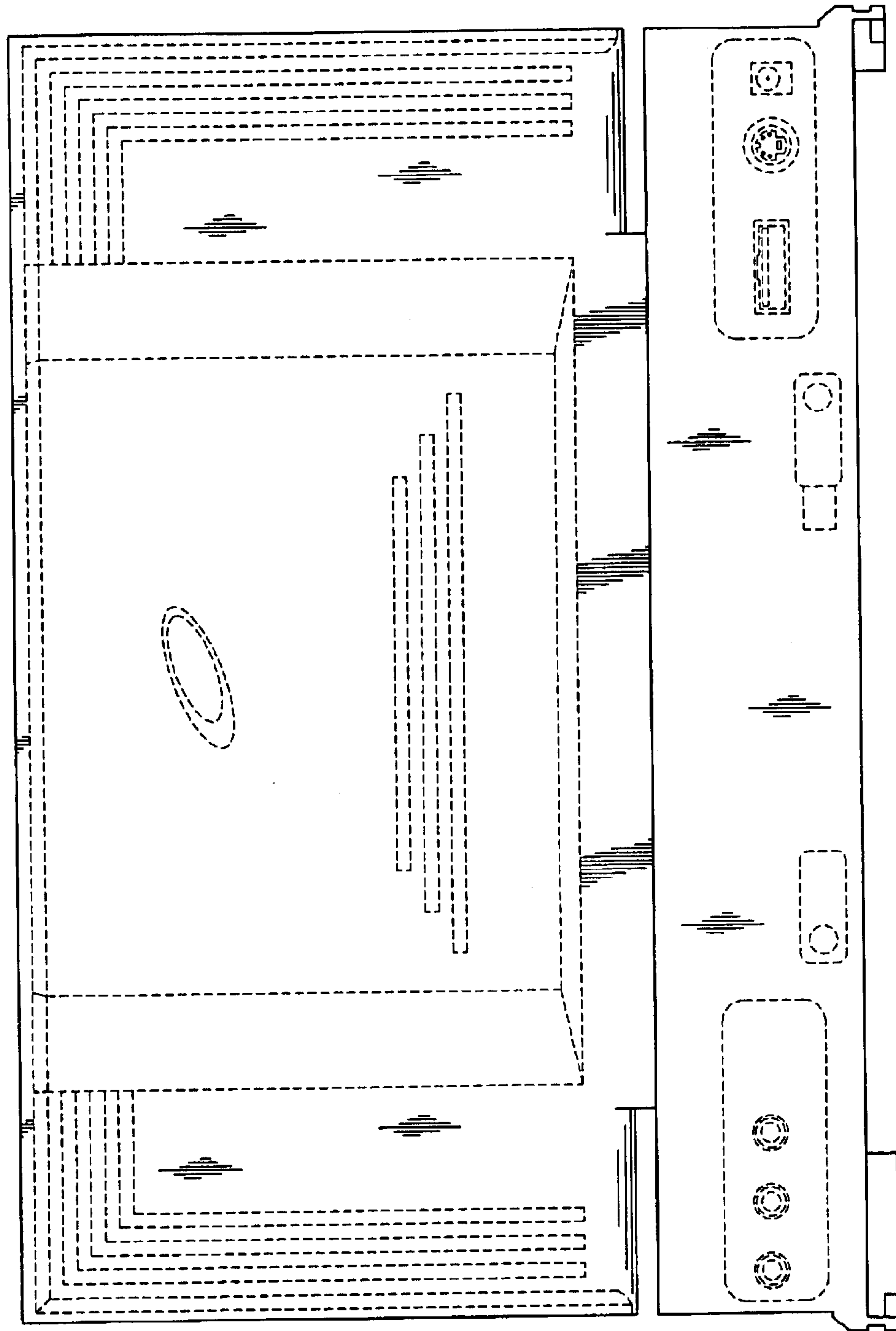

Fig. 4

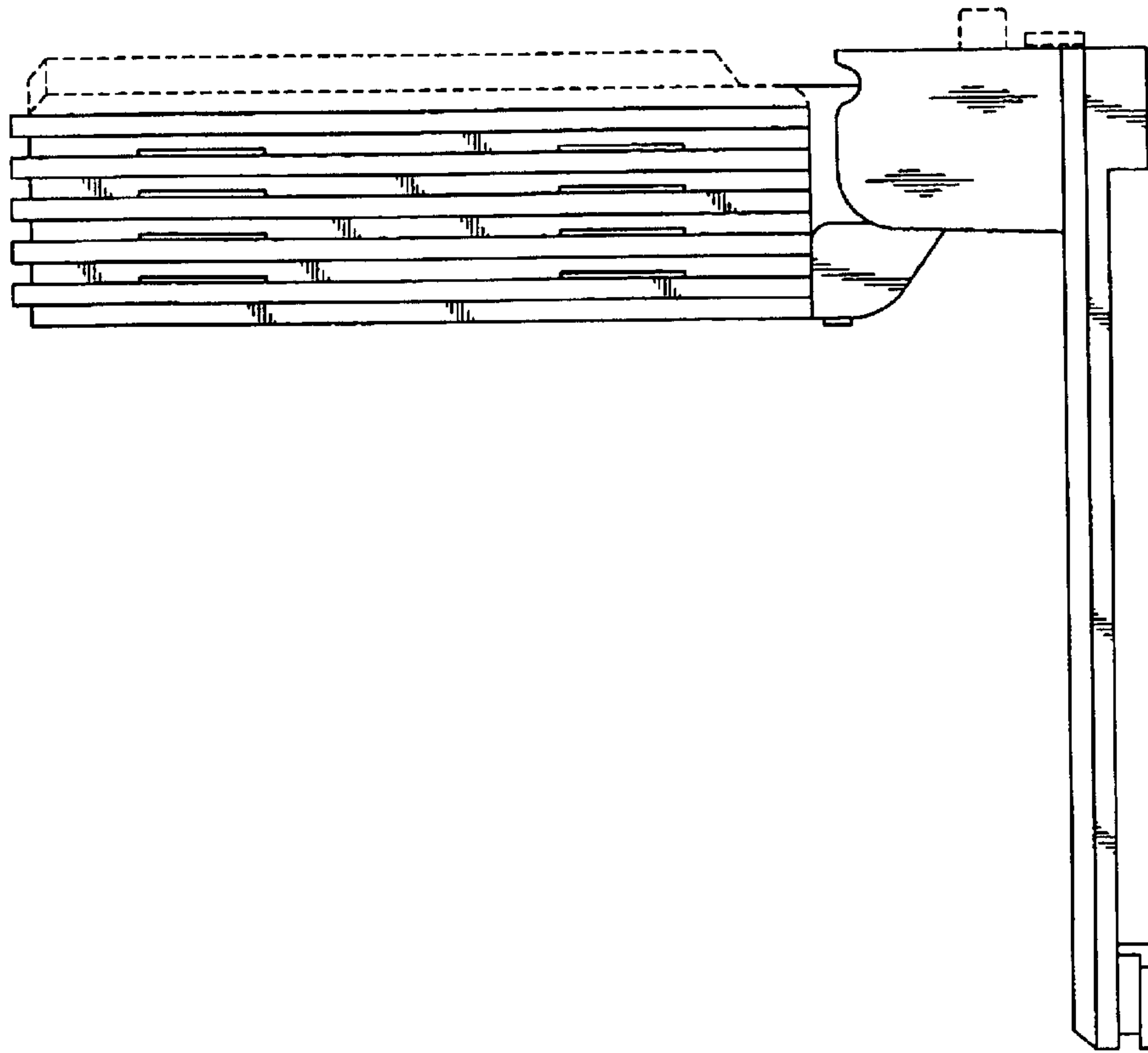

Fig. 3

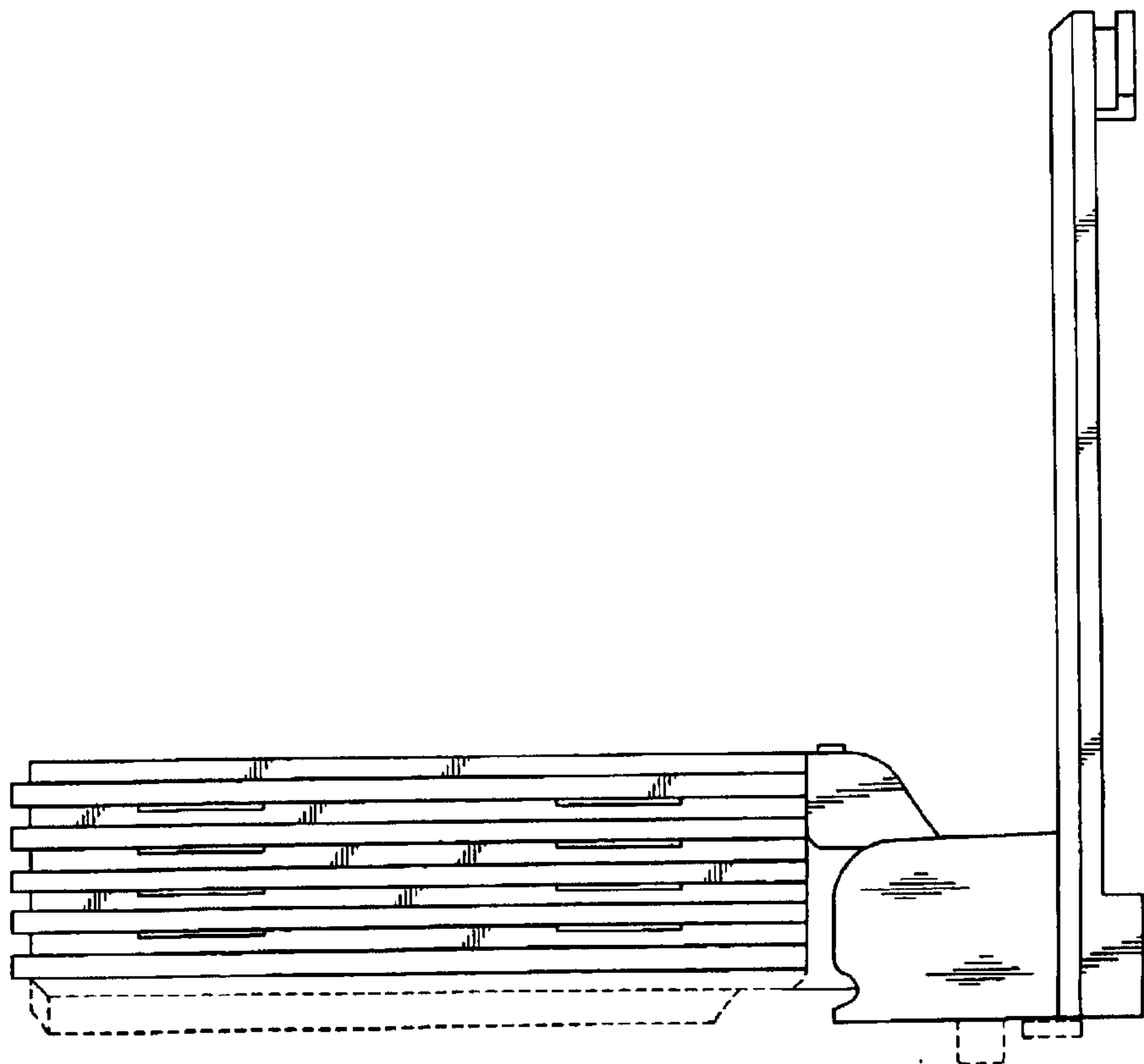

Fig. 5

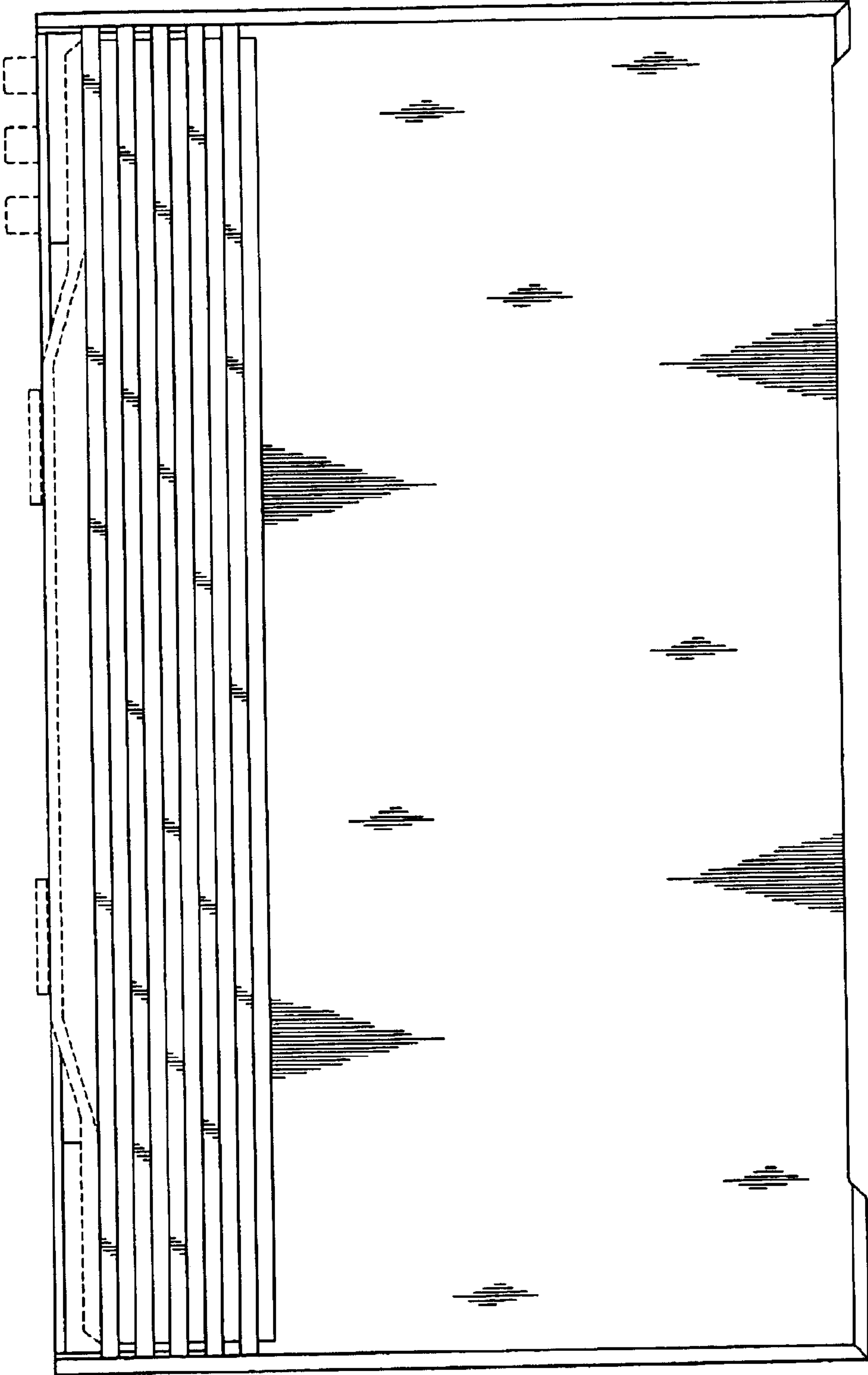

Fig. 6

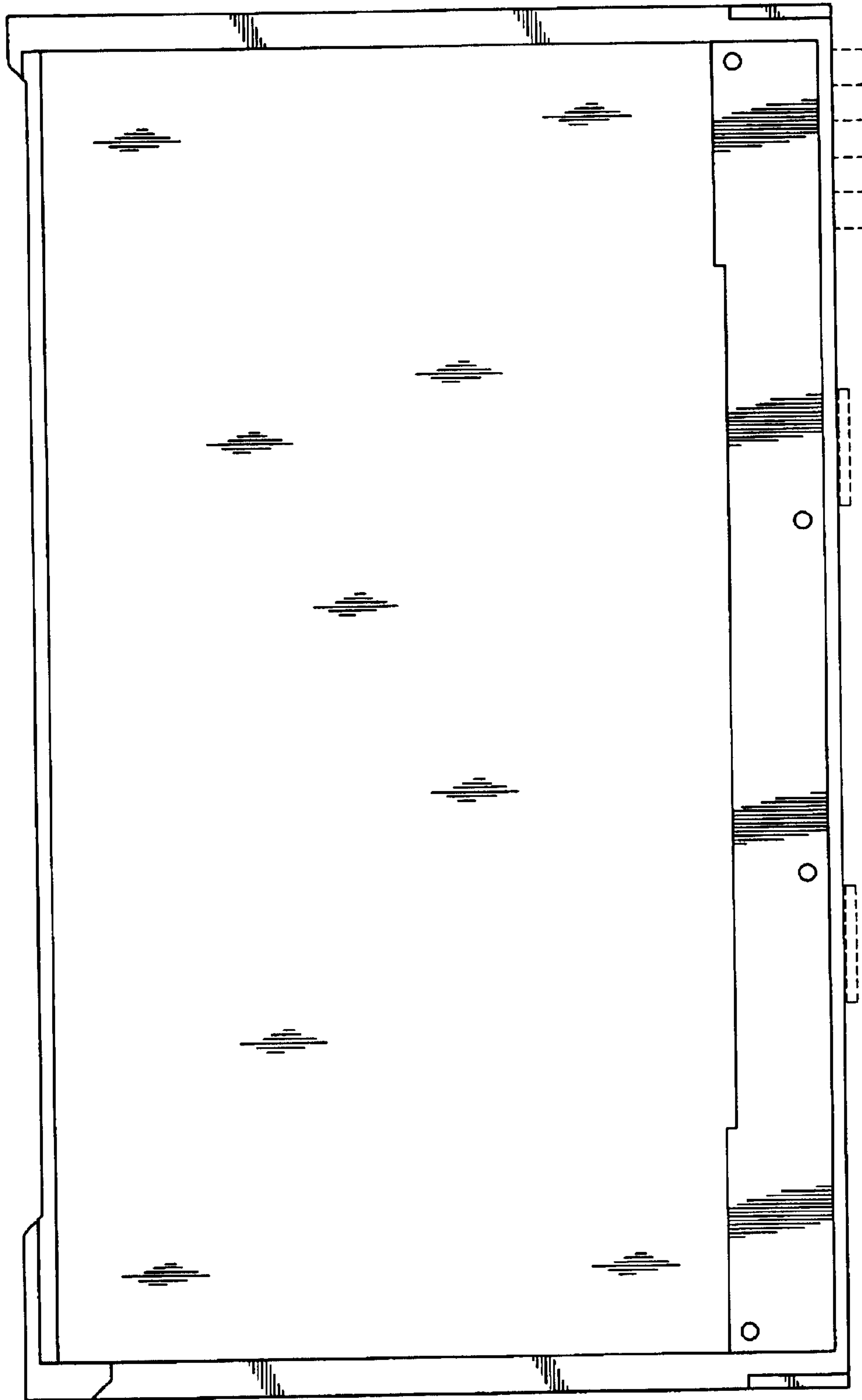

Fig. 7

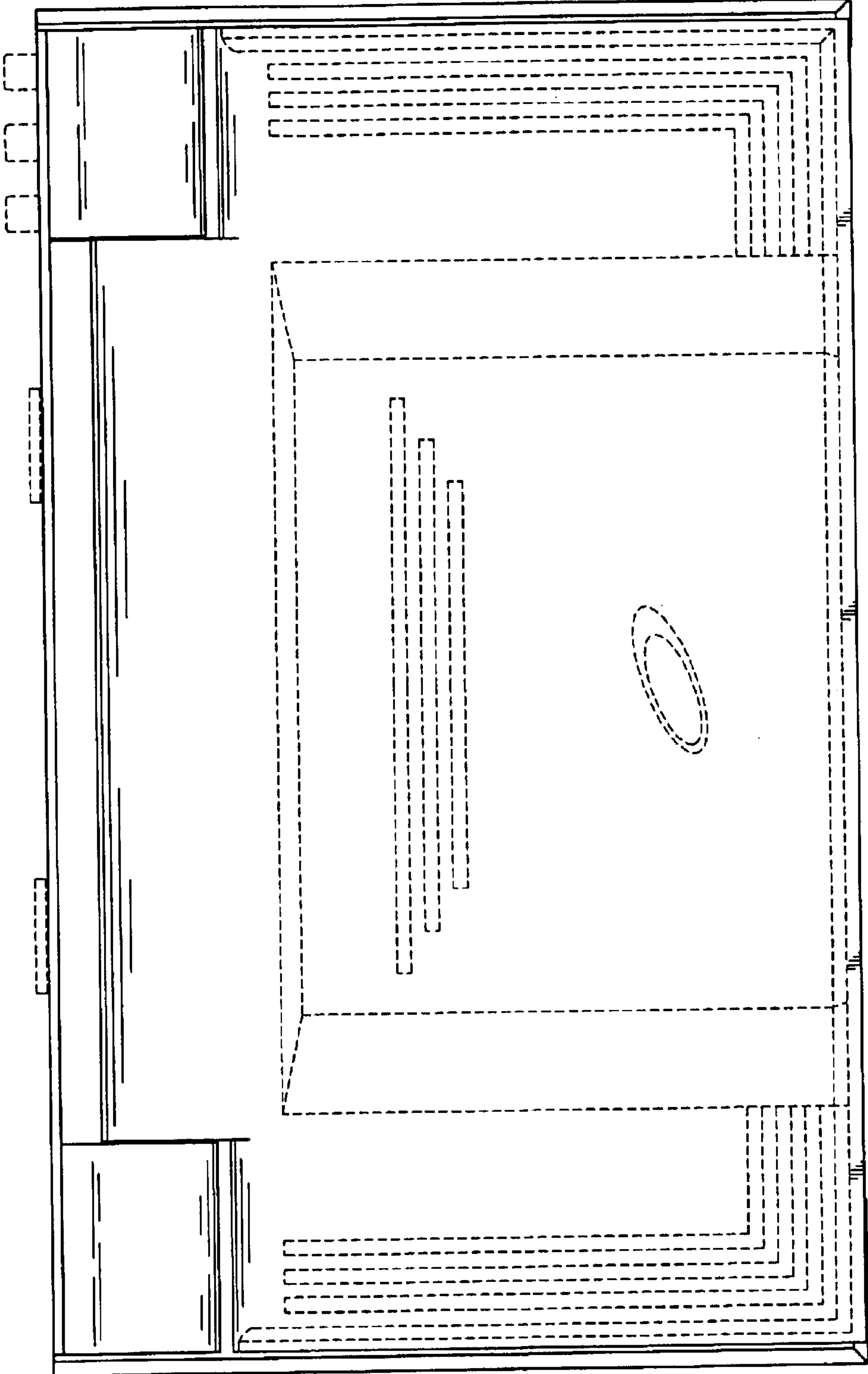

Fig. 8

