



US00D512976S

(12) **United States Design Patent**
Lee

(10) **Patent No.:** **US D512,976 S**
(45) **Date of Patent:** **** Dec. 20, 2005**

(54) **INTEGRATED TELEPHONE COMPACT DISK PLAYER**
(75) Inventor: **Johan Lee**, Sunnyside, NY (US)
(73) Assignee: **Coby Electronics Corp.**, Maspeth, NY (US)
(**) Term: **14 Years**

5,416,838 A * 5/1995 Liebing et al. 379/436
D412,504 S * 8/1999 Renk D14/156
D418,488 S * 1/2000 NG et al. D14/329
D447,738 S * 9/2001 Usami et al. D14/136
D452,222 S * 12/2001 Lee D14/130
D466,884 S * 12/2002 Clayton D14/168
D468,711 S * 1/2003 Chang D14/129
D485,540 S * 1/2004 Isshiki D14/129
D486,457 S * 2/2004 Lee D14/129
D489,348 S * 5/2004 Robertson, Jr. et al. ... D14/151
D502,461 S * 3/2005 Jones D14/168
D503,395 S * 3/2005 Hirano D14/168

(21) Appl. No.: **29/206,010**
(22) Filed: **May 24, 2004**

FOREIGN PATENT DOCUMENTS

(51) **LOC (6) Cl.** **14-03**
(52) **U.S. Cl.** **D14/144; D14/149**
(58) **Field of Search** D14/149-151,
D14/147-148, 251-253, 144, 143, 130,
329, 330, 434, 140, 142, 129, 132, 156,
168, 171, 152, 153; 379/419, 428.01-428.04,
440; D13/107, 108; D21/517

WO DM/064420 * 11/2002

* cited by examiner

Primary Examiner—Jeffrey Asch
(74) *Attorney, Agent, or Firm*—Brown Raysman Millstein Felder & Steiner

(56) **References Cited**

U.S. PATENT DOCUMENTS

3,301,958 A * 1/1967 Blakeslee et al. 379/69
D231,740 S * 6/1974 Wolf et al. D14/152
D239,407 S * 3/1976 van de Poel D14/136
D256,582 S * 8/1980 Owens D14/144
D256,917 S * 9/1980 De Filippis et al. D14/144
4,220,828 A * 9/1980 Ruzic 379/369
D268,670 S * 4/1983 Iwaoka et al. D14/136
D278,812 S * 5/1985 Topp D14/144
D284,193 S * 6/1986 Marshall D14/327
D290,358 S * 6/1987 Brandsma et al. D14/171
D294,691 S * 3/1988 Yoshida et al. D14/156
D317,757 S * 6/1991 Yokoi et al. D14/329
D331,409 S * 12/1992 Goldsmith et al. D14/218
D339,342 S * 9/1993 Chan D14/149
D339,343 S * 9/1993 Aellen D14/151
D347,633 S * 6/1994 Keung D14/151
D350,345 S * 9/1994 Lindeman et al. D14/125
5,412,417 A * 5/1995 Tozuka 348/14.01

(57) **CLAIM**

The ornamental design for an integrated telephone compact disk player, as shown and described.

DESCRIPTION

FIG. 1 is a perspective view of one side and the front of the device showing an operable compact disk door on the top of the device according to one embodiment of my design; FIG. 2 is a front view thereof; FIG. 3 is a back view thereof; FIG. 4 is a left side view thereof; FIG. 5 is a right side view thereof; FIG. 6 is a top view thereof; and, FIG. 7 is a bottom view thereof. The broken line showings throughout the views are for illustrative purposes only and form no part of the claimed design.

1 Claim, 7 Drawing Sheets

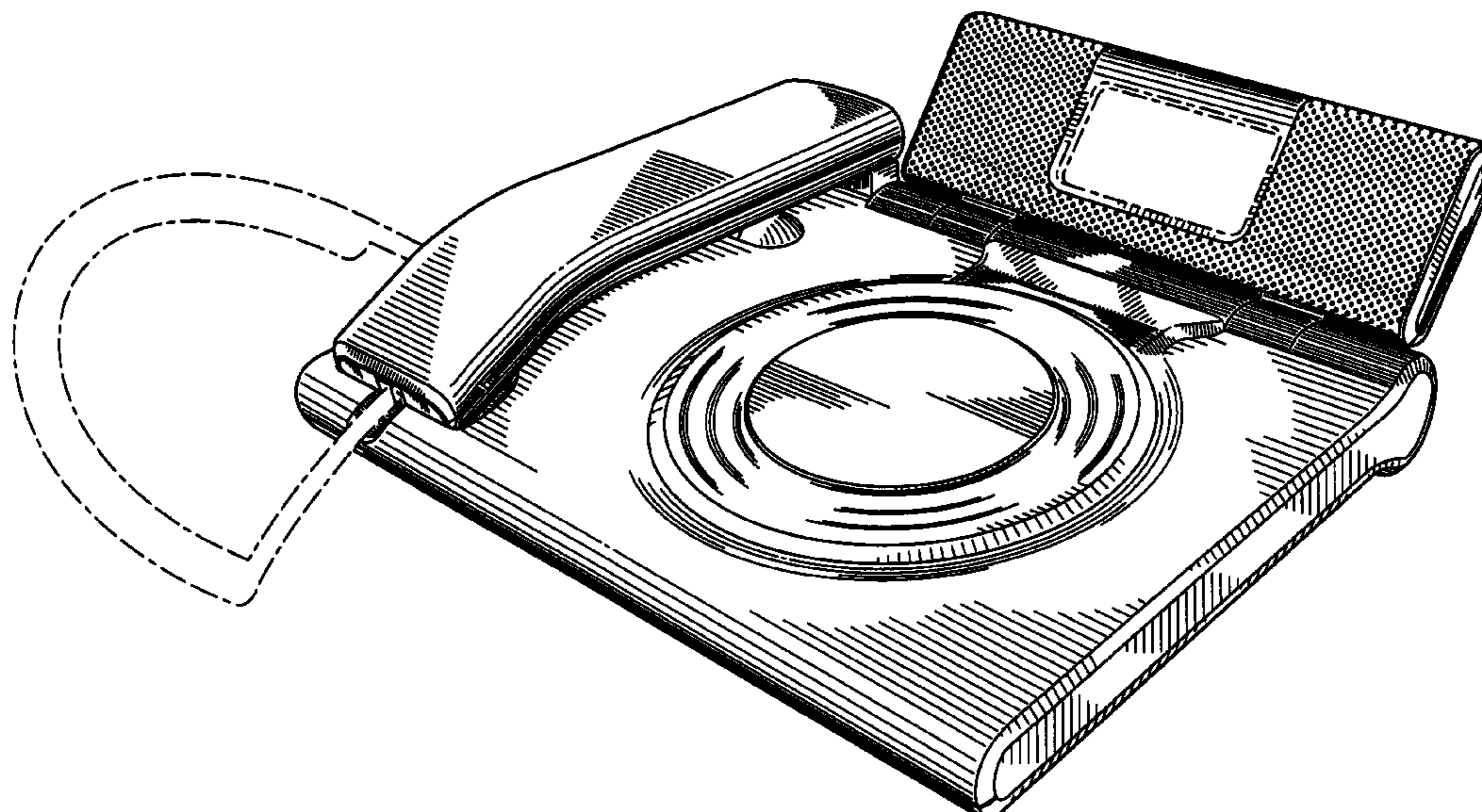

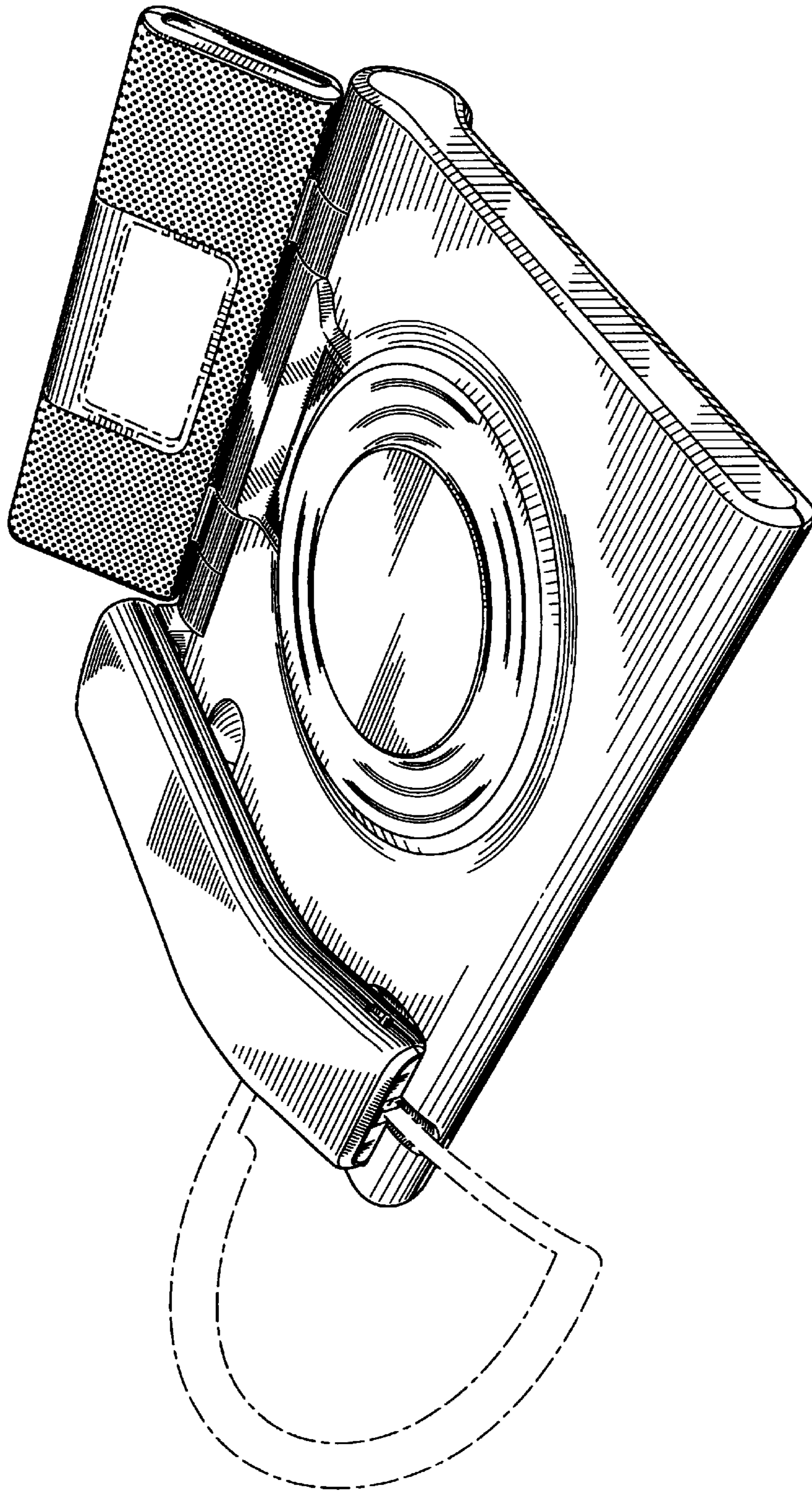

FIG. 1

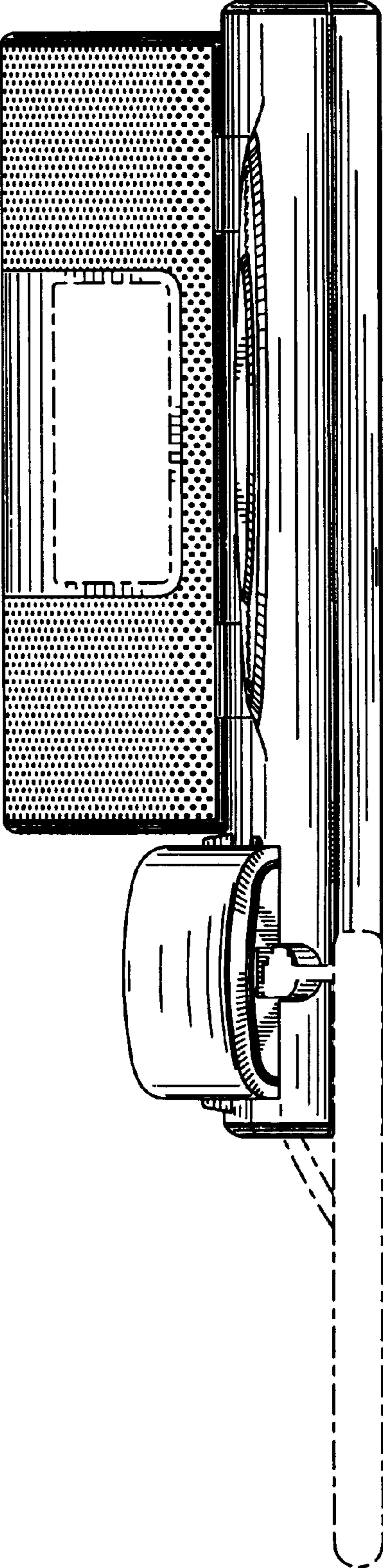

FIG. 2

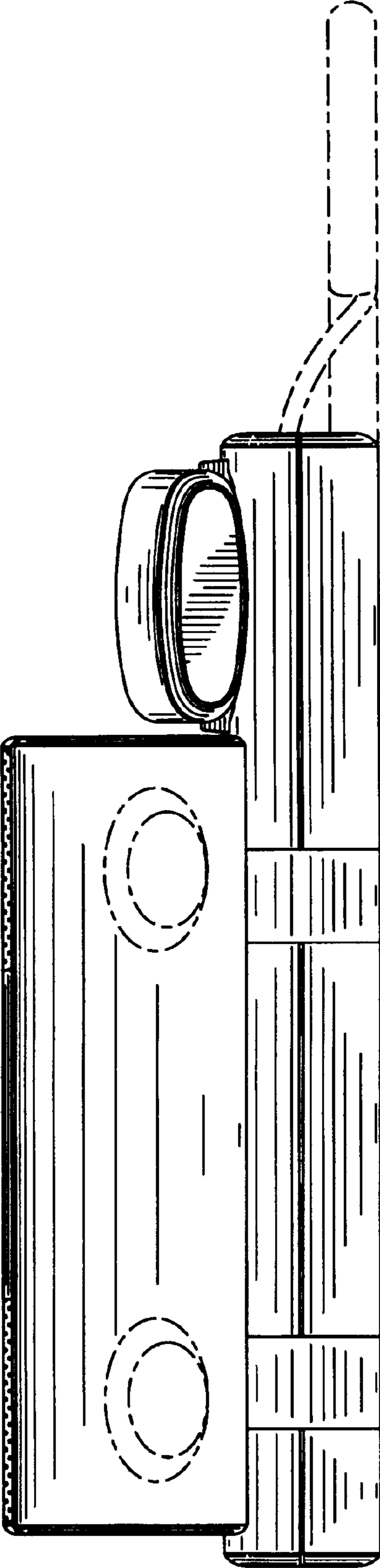

FIG. 3

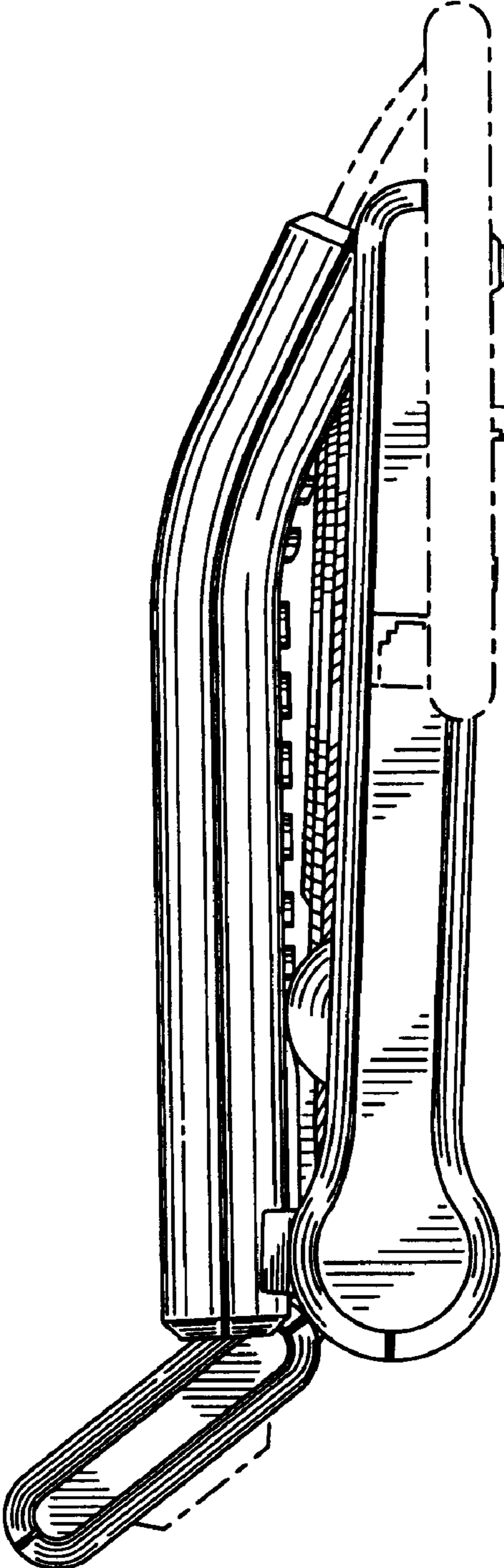

FIG. 4

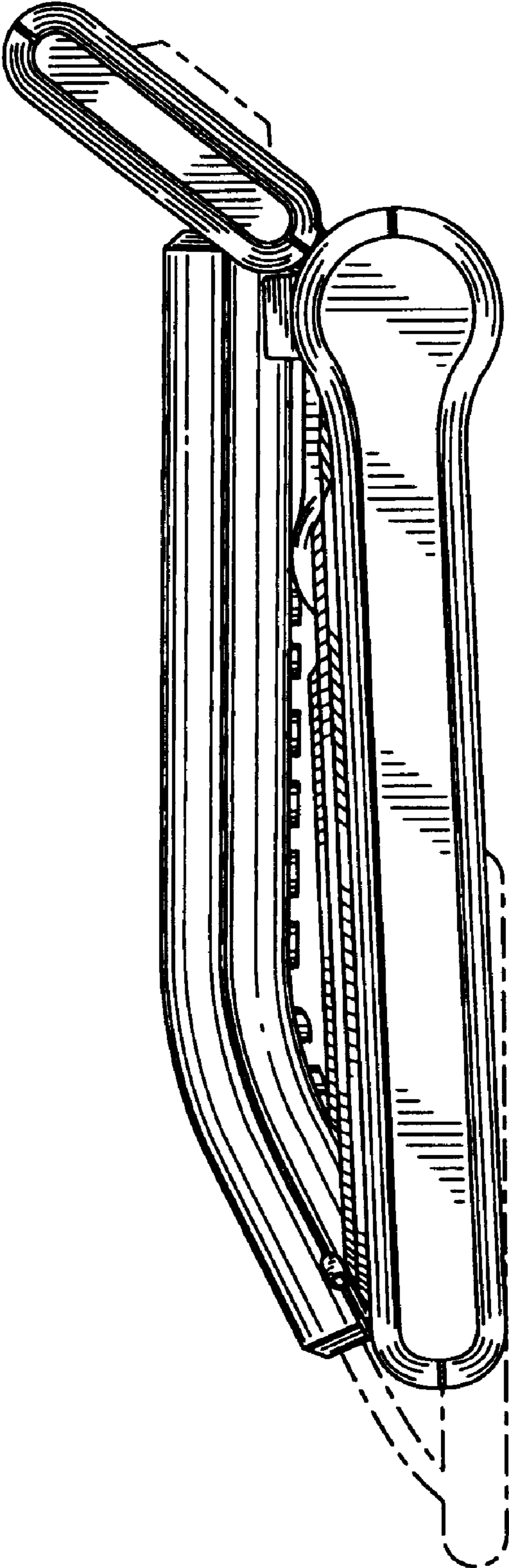

FIG. 5

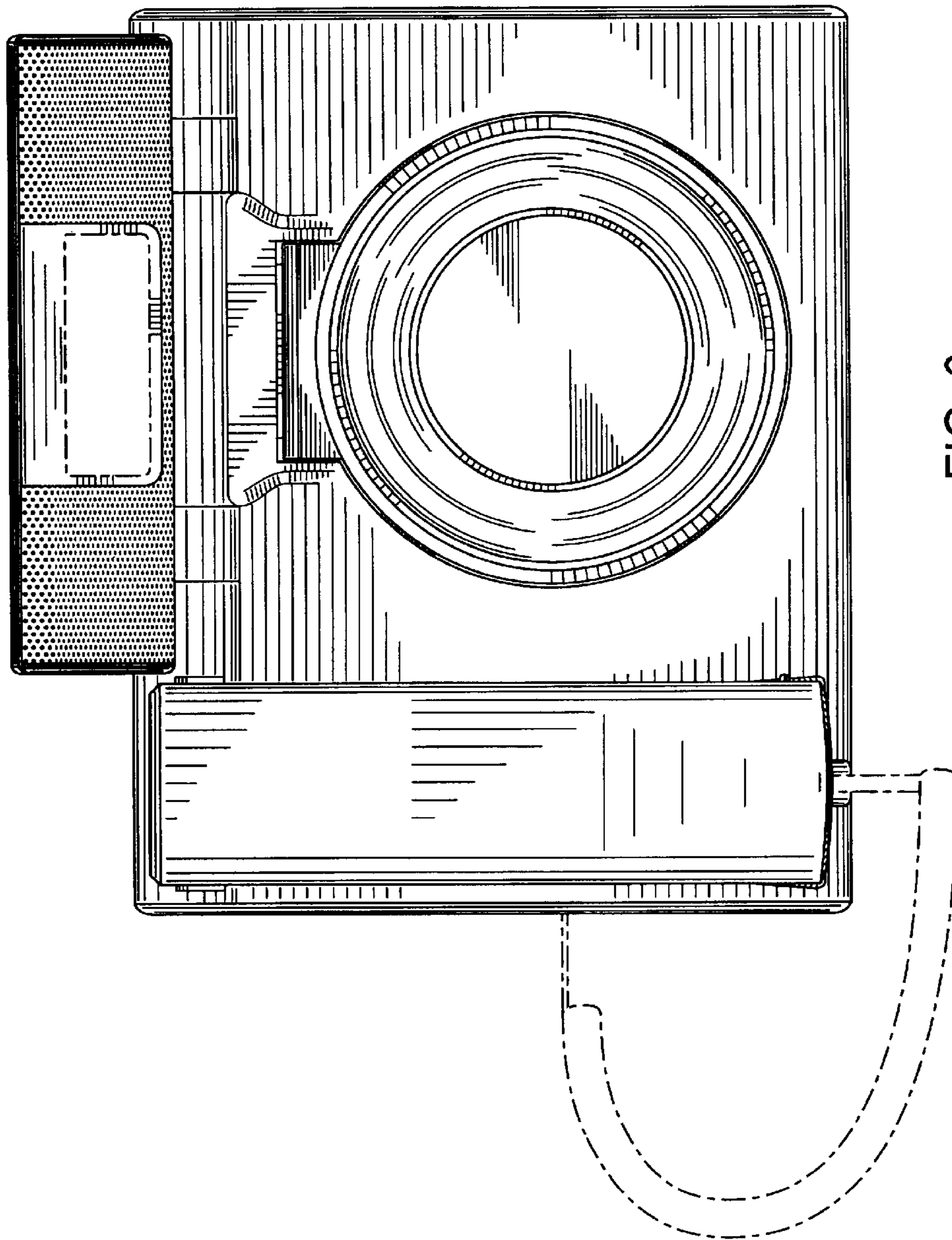

FIG. 6

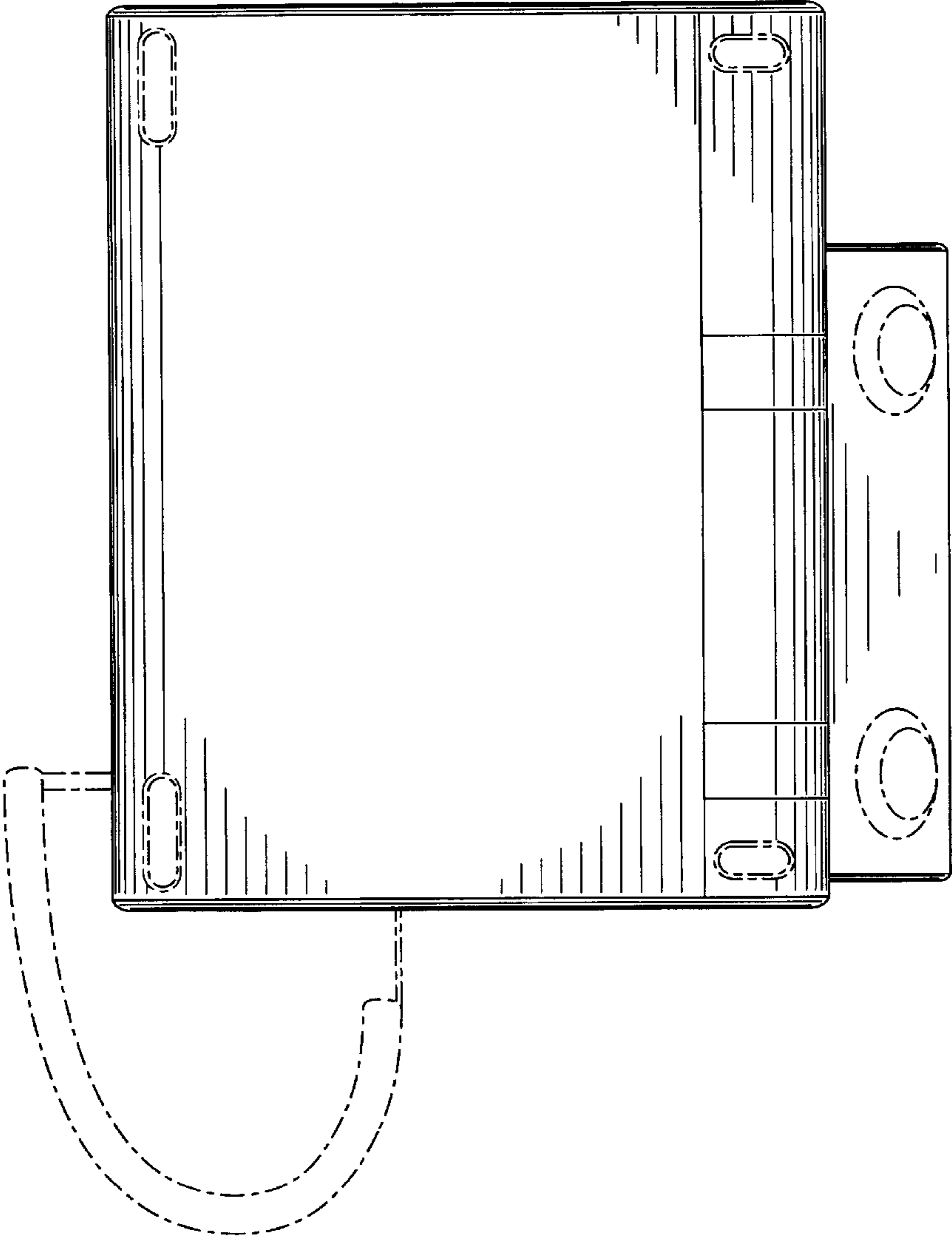

FIG. 7