



US00D512906S

(12) **United States Design Patent**
Wood

(10) **Patent No.: US D512,906 S**

(45) **Date of Patent: ** Dec. 20, 2005**

(54) **MAGNETIC CLIP**

(75) **Inventor: George W. Wood, Minneapolis, MN (US)**

(73) **Assignee: Locker Mate Corporation**

(**) **Term: 14 Years**

(21) **Appl. No.: 29/225,137**

(22) **Filed: Mar. 11, 2005**

(51) **LOC (6) Cl. 08-08**

(52) **U.S. Cl. D8/395**

(58) **Field of Search** D8/356, 371, 394-396, D8/499, 53, 100, 365; D12/51; D19/65, 90; D28/39, 40, 42; 24/546, 563, 327, 334, DIG. 8, DIG. 9, DIG. 13, DIG. 28; 248/74.2, 300, 301, 316.7, 229.26

(56) **References Cited**

U.S. PATENT DOCUMENTS

D328,242 S 7/1992 Chan
D348,902 S * 7/1994 Beyer D19/65

D352,624 S 11/1994 Voiss
5,996,821 A 12/1999 Farber et al.
D464,994 S * 10/2002 Rosen D19/65
D477,988 S * 8/2003 Adams et al. D8/395

* cited by examiner

Primary Examiner—Doris Clark
Assistant Examiner—John Windmuller
(74) *Attorney, Agent, or Firm*—Beck & Tysver, P.L.L.C.

(57) **CLAIM**

The ornamental design for a magnetic clip, as shown.

DESCRIPTION

FIG. 1 is a perspective view of a magnetic clip showing our new design;
FIG. 2 is a top plan view thereof;
FIG. 3 is a bottom plan view thereof;
FIG. 4 is a left side elevational view thereof;
FIG. 5 is a right side elevational view thereof;
FIG. 6 is a front elevational view thereof; and,
FIG. 7 is a rear elevational view thereof.

1 Claim, 2 Drawing Sheets

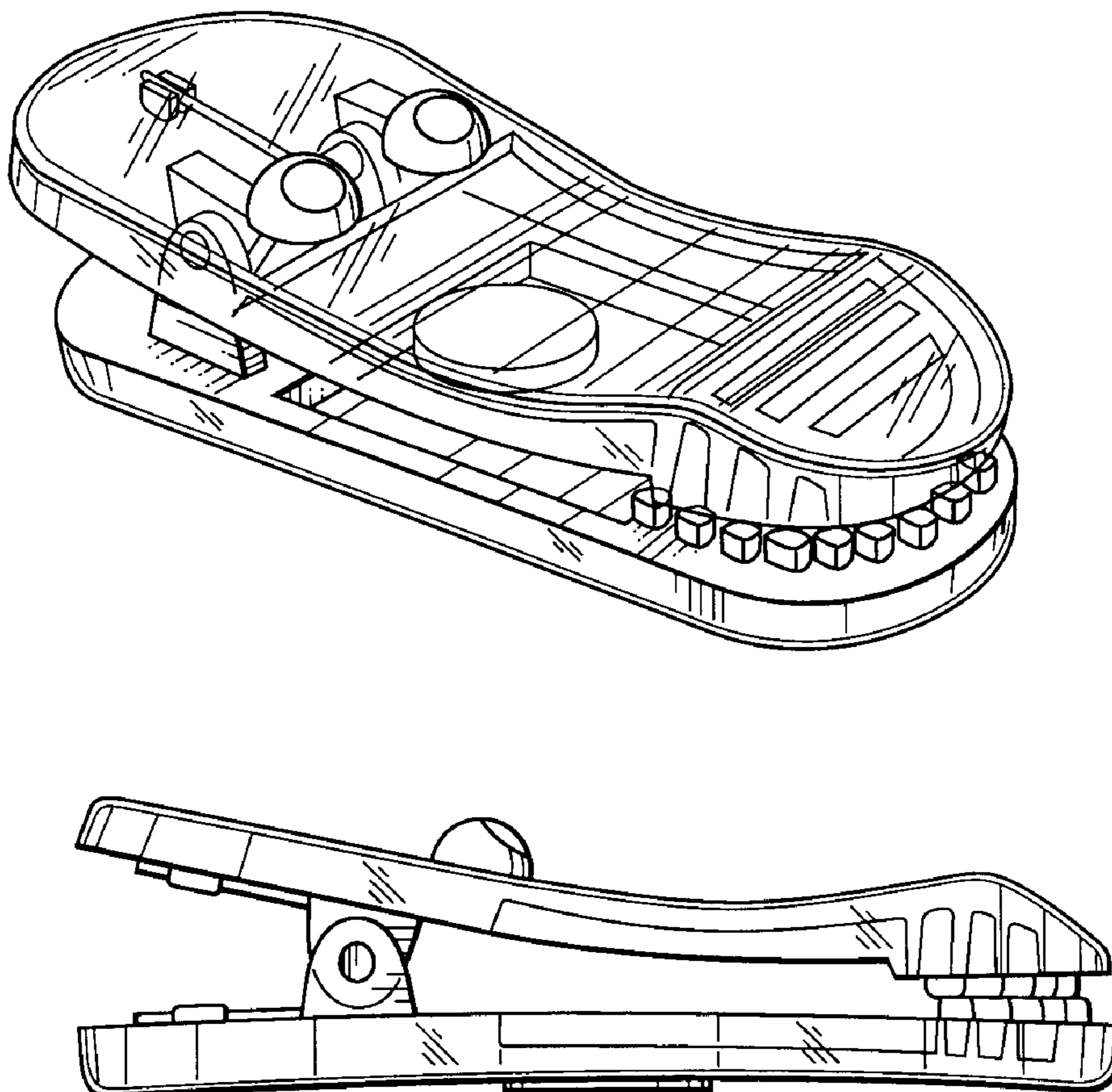

Fig. 1

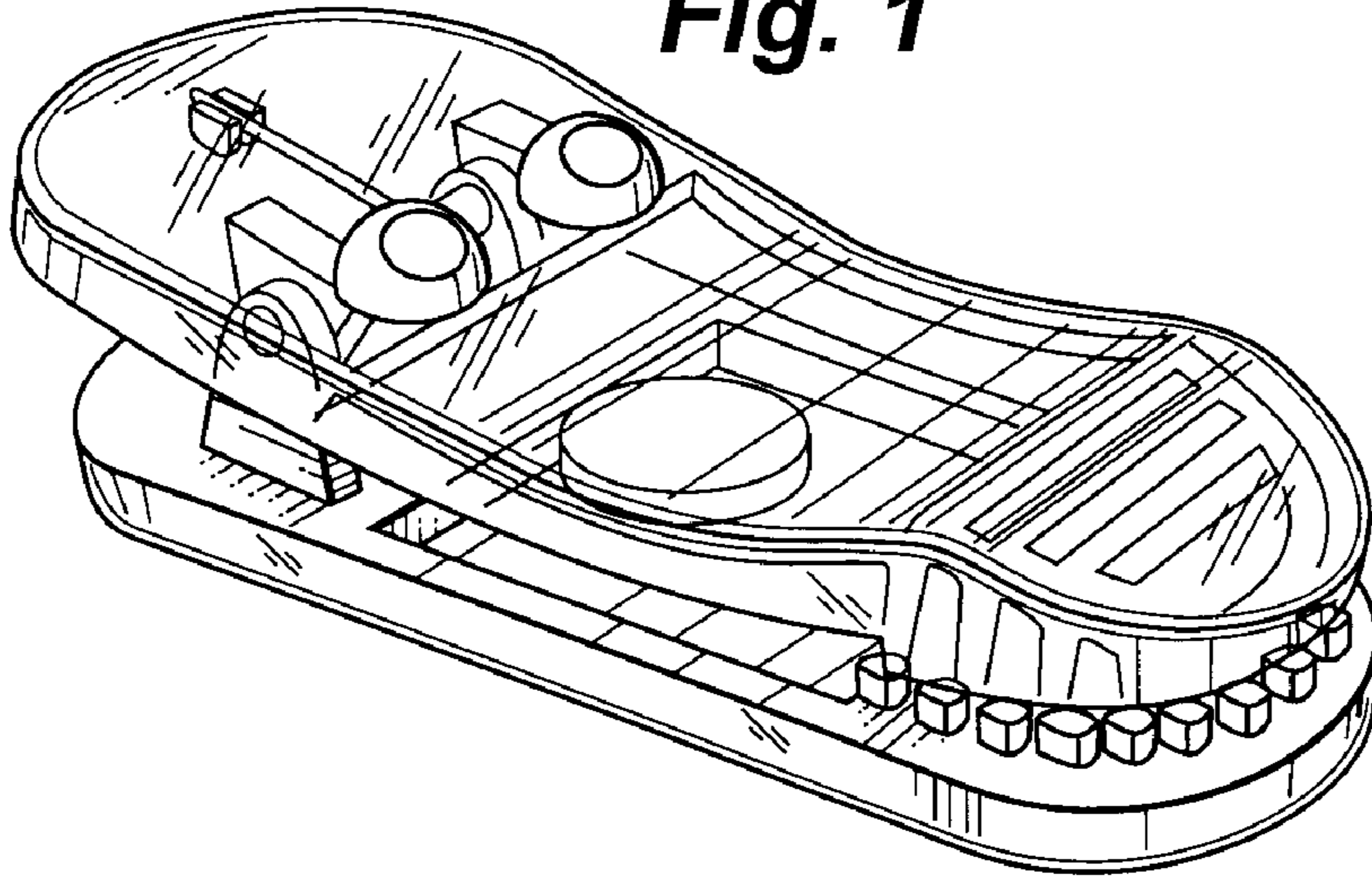

Fig. 2

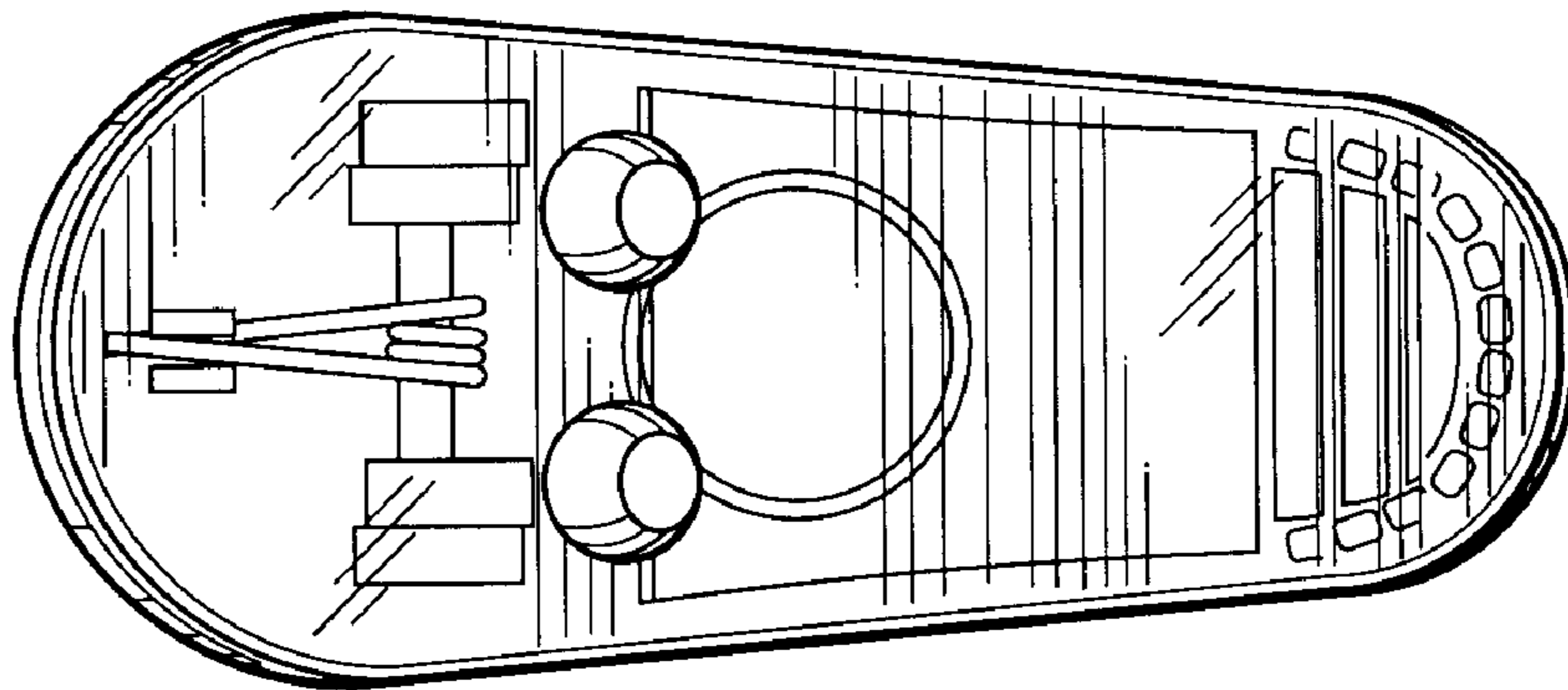

Fig. 3

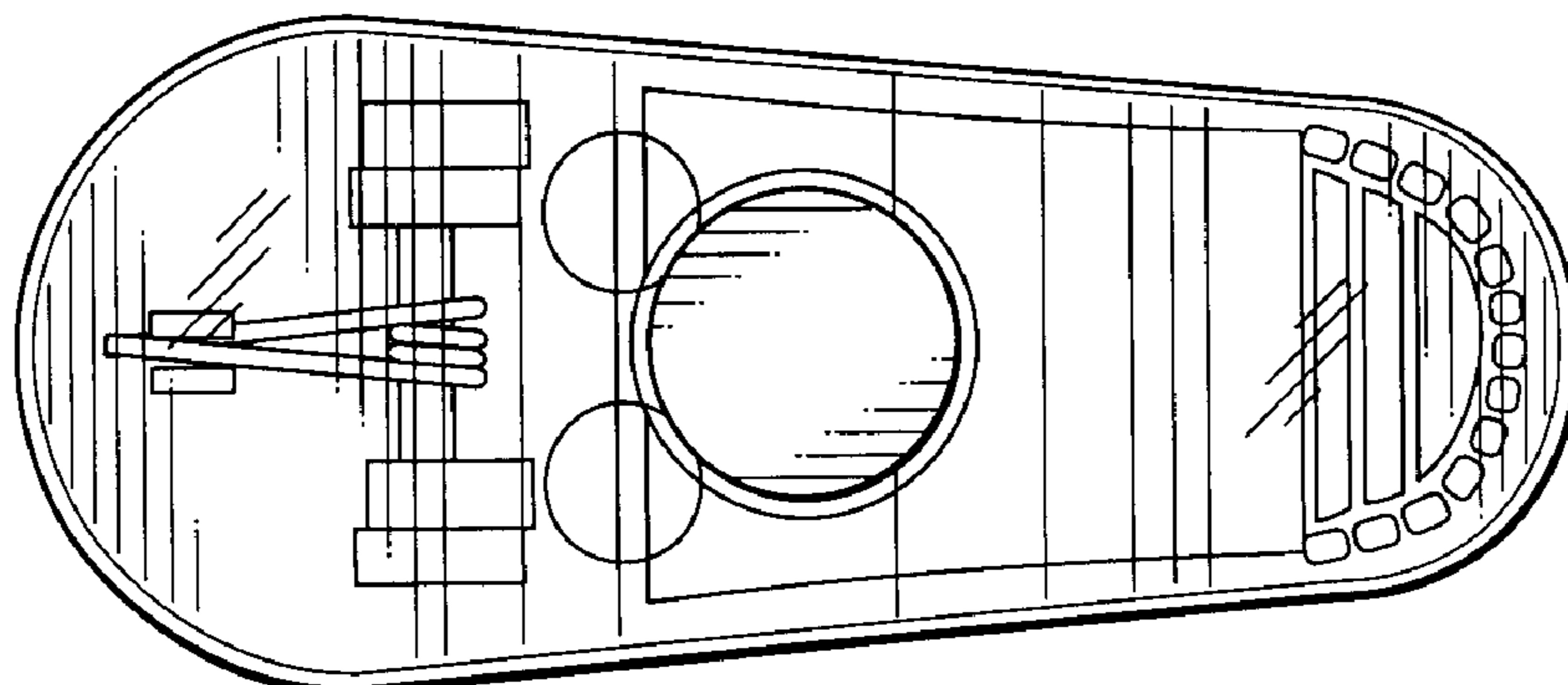

Fig. 4

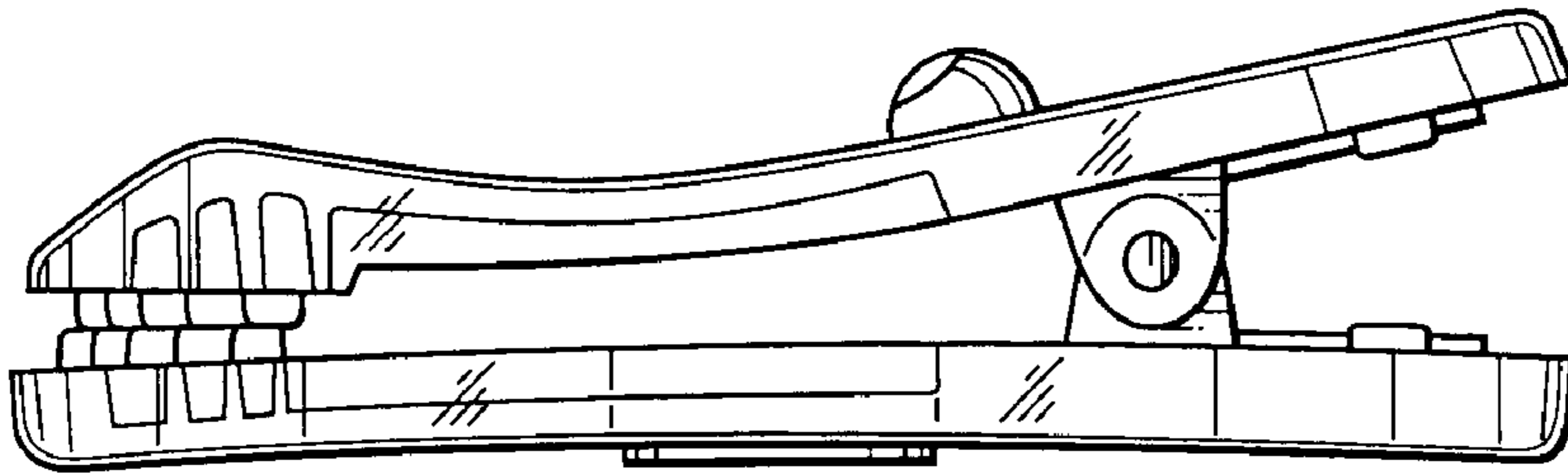

Fig. 5

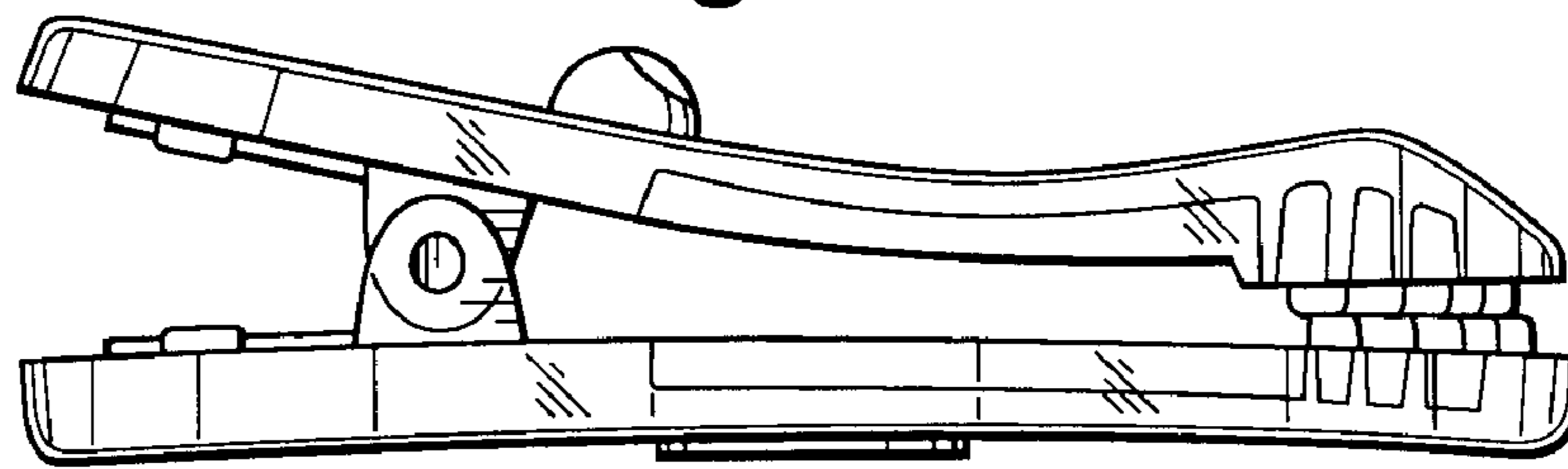

Fig. 6

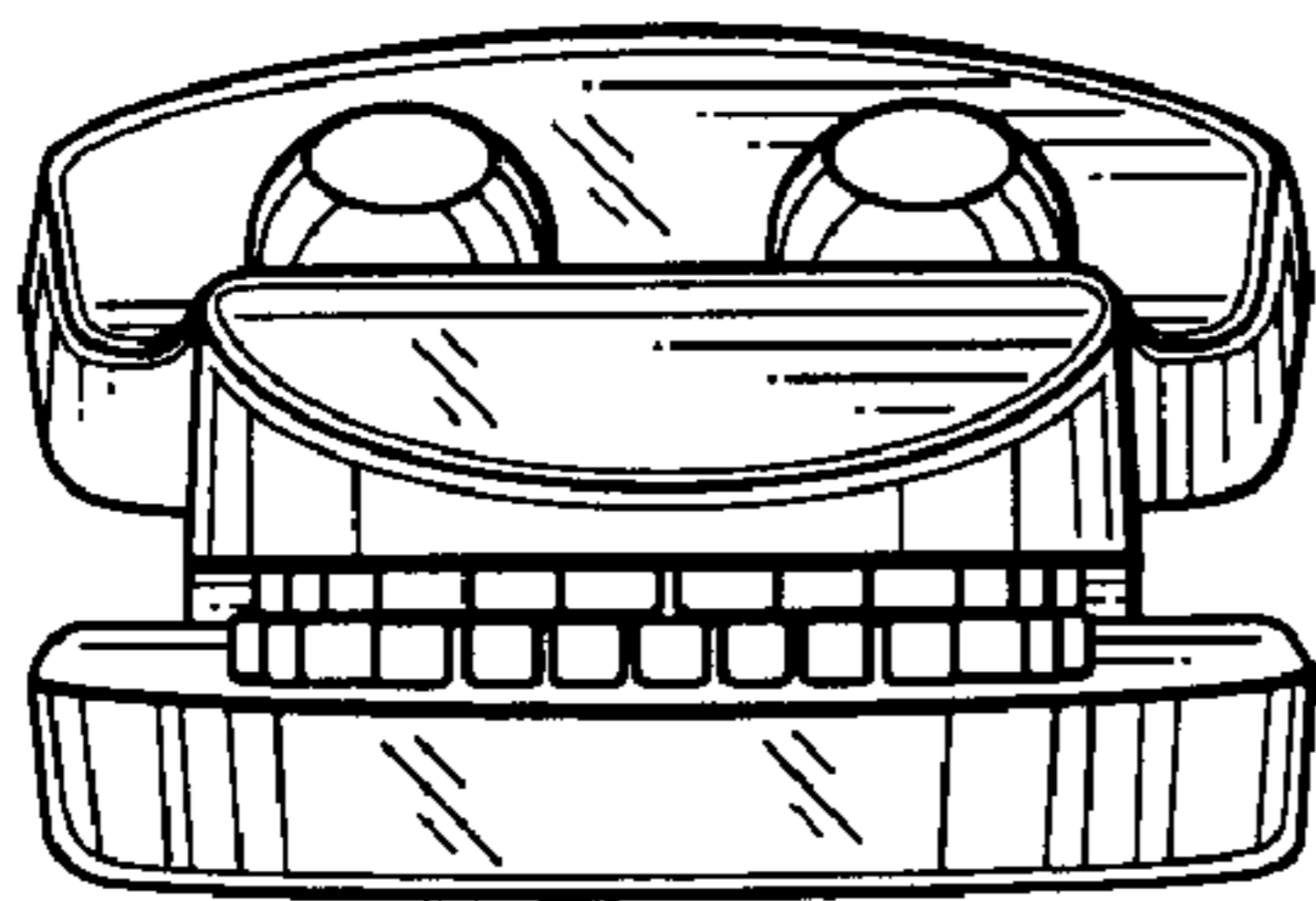

Fig. 7

