



US00D512874S

(12) **United States Design Patent**  
**Poulson et al.**

(10) **Patent No.:** **US D512,874 S**

(45) **Date of Patent:** **\*\* Dec. 20, 2005**

(54) **BEVERAGE BOTTLE**

(75) Inventors: **Keith Poulson**, Loveland, CO (US);  
**Kam Fu Choo**, O'Fallon, MO (US)

(73) Assignee: **American Recreation Products, Inc.**,  
St. Louis, MO (US)

(\*\*) **Term:** **14 Years**

(21) **Appl. No.:** **29/197,862**

(22) **Filed:** **Jan. 21, 2004**

(51) **LOC (6) Cl.** ..... **07-01**

(52) **U.S. Cl.** ..... **D7/510; D7/511**

(58) **Field of Search** ..... D7/510, 511, 523,  
D7/507, 509, 605, 612, 620, 532, 531,  
608, 629; D9/503, 446, 560, 557, 502,  
511, 556, 538; D3/271.1, 294, 905; D15/150;  
220/592.27, 592.16, 263, 509, 516, 518,  
780, 23.87, 711, 703, 592.17; 215/388,  
399, 132.1, 12.1, 12.2; 210/85, 282; 366/341;  
224/414; 116/284; 206/543, 542, 459.1,  
217; 222/243

(56) **References Cited**

**U.S. PATENT DOCUMENTS**

- 3,606,262 A \* 9/1971 Vant Hoff ..... 366/341
- 4,366,922 A \* 1/1983 Levine et al. .... 224/414
- D272,139 S \* 1/1984 Boughton ..... D7/510
- D324,822 S \* 3/1992 Brabeck et al. .... D9/560
- D332,215 S \* 1/1993 Halvorson ..... D9/503
- D339,503 S 9/1993 Callaway ..... D7/510
- D350,672 S 9/1994 Egger et al. .... D7/510
- D358,964 S \* 6/1995 Foster et al. .... D7/510
- D387,197 S \* 12/1997 Huang ..... D3/271.1
- D391,448 S \* 3/1998 Winer et al. .... D7/510
- D410,821 S \* 6/1999 Huang ..... D7/608

- D469,360 S \* 1/2003 Moore et al. .... D9/556
- 6,565,743 B1 \* 5/2003 Poirier et al. .... 210/85
- D496,559 S \* 9/2004 Bodum ..... D7/510

**OTHER PUBLICATIONS**

Nalgene Products, <http://web.archive.org/web/20030205224351/www.nalgene-outdoor.com/>.  
 Coleman Round P.C. Bottle, [http://www.coleman.com/coleman/colemancom/detail.asp?product\\_id=809-332T](http://www.coleman.com/coleman/colemancom/detail.asp?product_id=809-332T).  
 In Zone Inc. Sports Bottles, <http://www.inzoneusa.com/h2goadults2.asp>, printed May 22, 2003.  
 Specialized Big Mouth Waterbottle, <http://www.specialized.com/SBCEqProduct.jsp?section=12835&browselevel=top&JServS>, printed May 22, 2003.  
 Thermos Nissan Vacuum Insulated Bottles, Mugs and Cookware, <http://www.coffee-makers-esspresso-machines.com/thermosnissan.html>, printed Jul. 3, 2003.

\* cited by examiner

*Primary Examiner*—M. N. Pandozzi

(74) *Attorney, Agent, or Firm*—Senniger Powers

(57) **CLAIM**

The ornamental design for a beverage bottle, as shown and described.

**DESCRIPTION**

FIG. 1 is a perspective view of a beverage bottle showing our new design;  
 FIG. 2 is a front elevational view thereof;  
 FIG. 3 is a rear elevational view thereof;  
 FIG. 4 is a right side elevational view thereof;  
 FIG. 5 is a left side elevational view thereof;  
 FIG. 6 is a top plan view thereof; and,  
 FIG. 7 is a bottom plan view thereof.

**1 Claim, 6 Drawing Sheets**

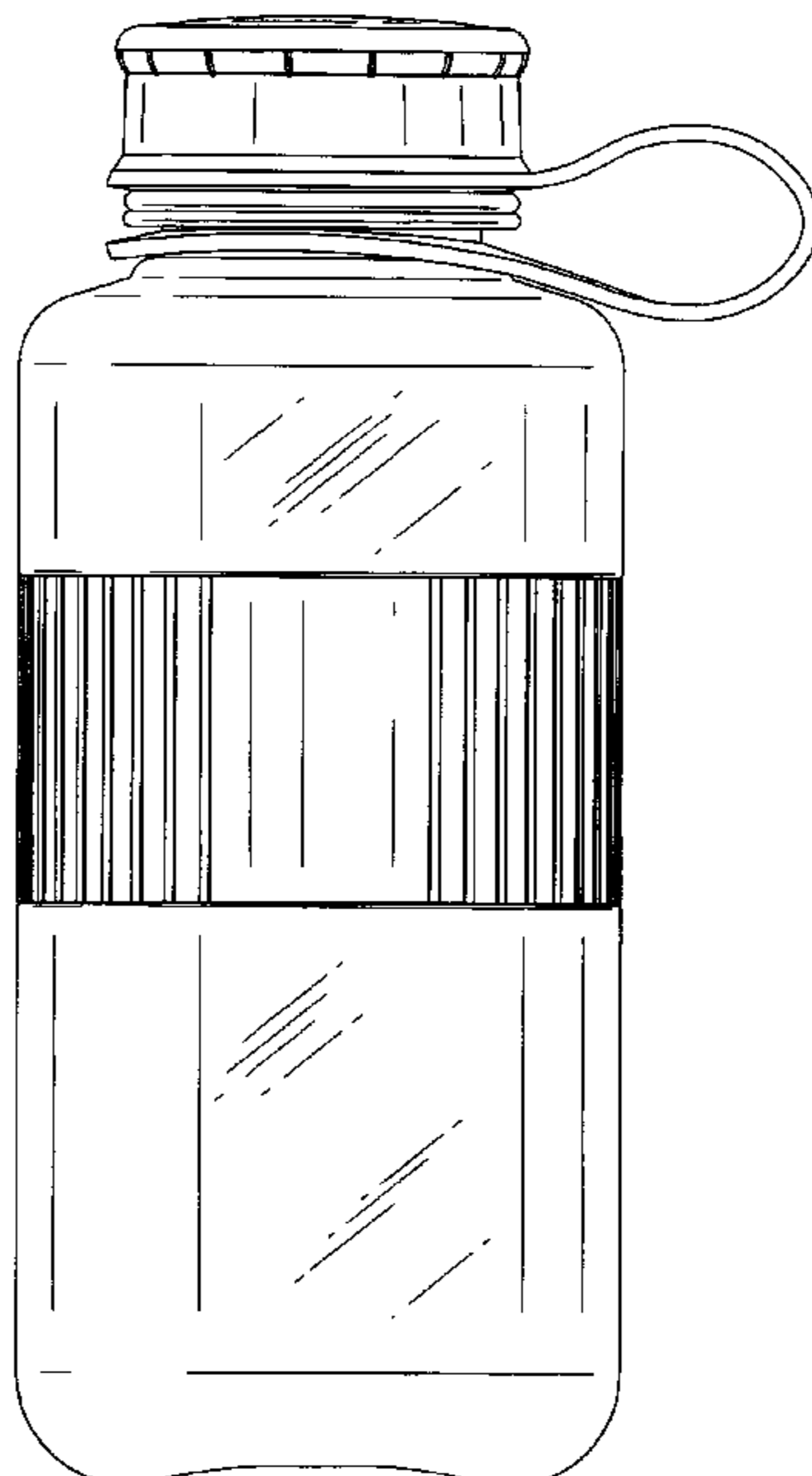

FIG. 1

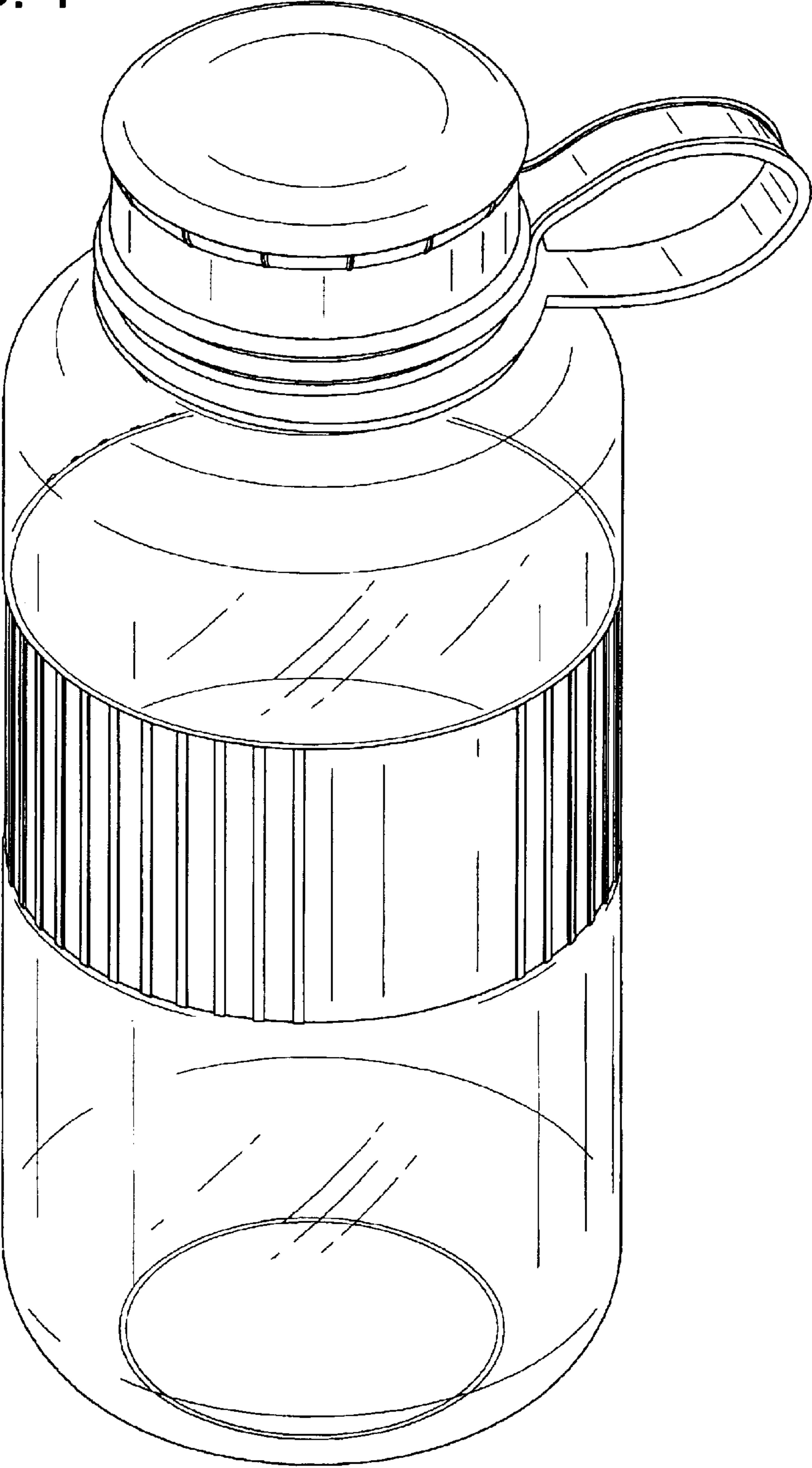

FIG. 2

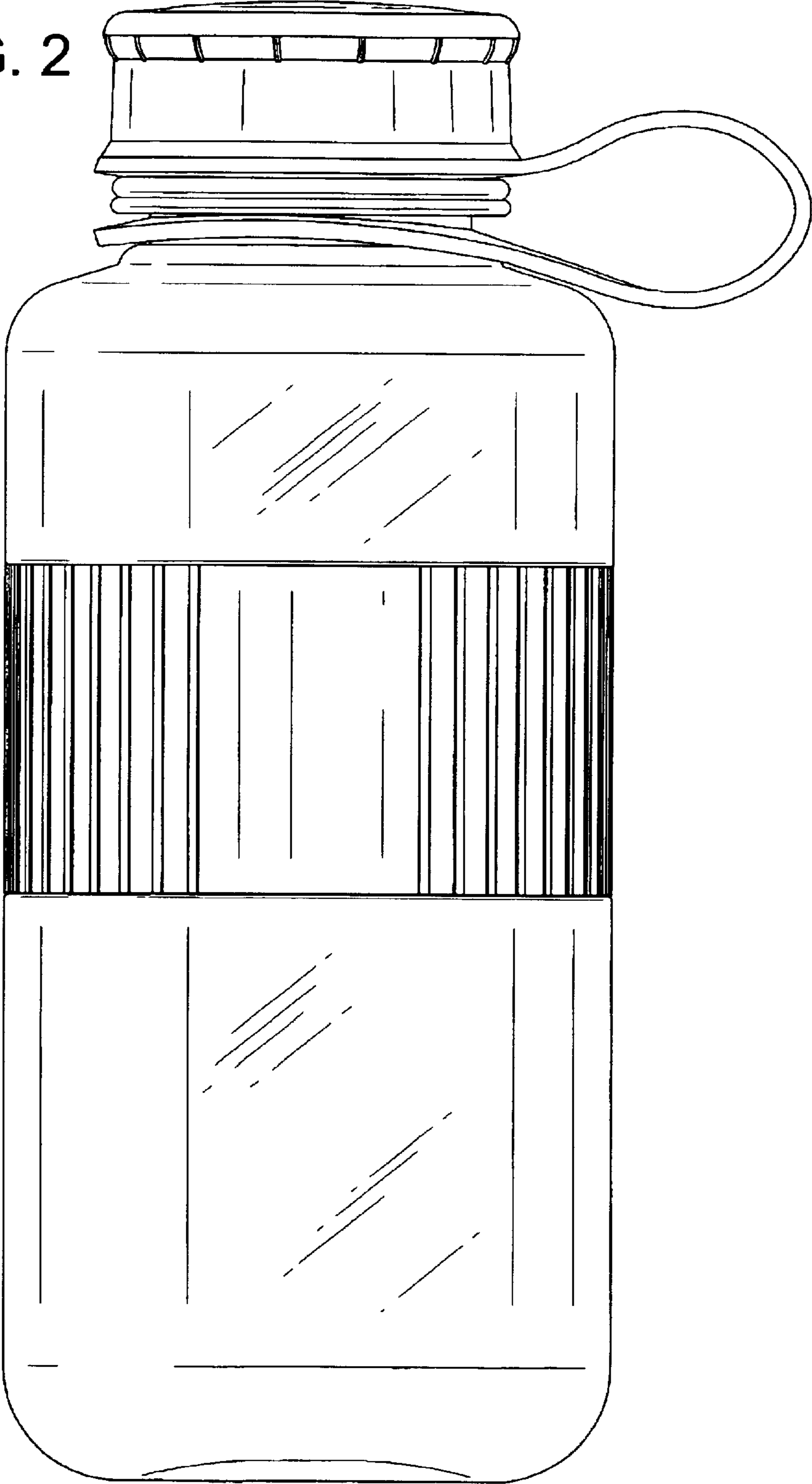

FIG. 3

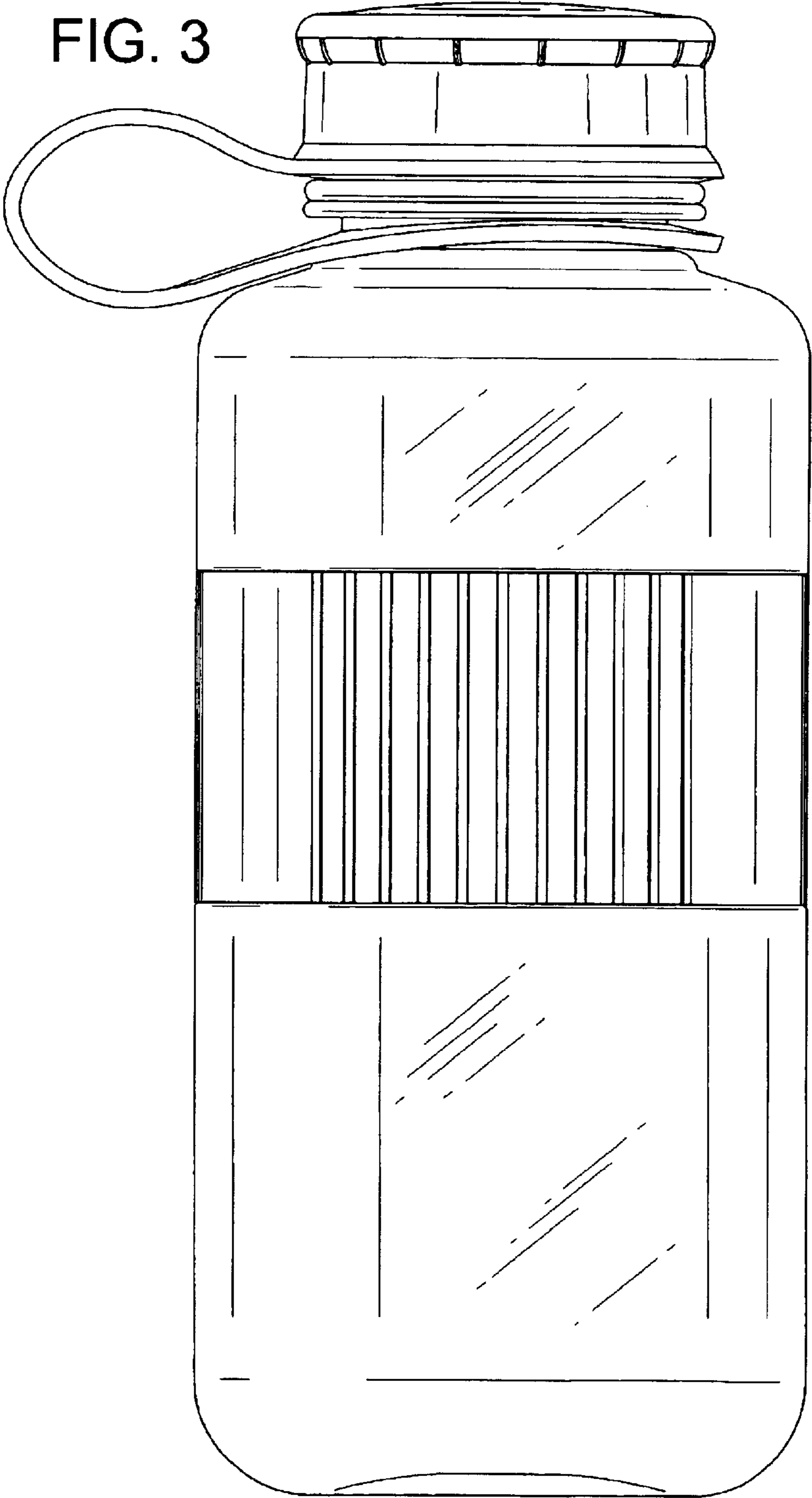

FIG. 4

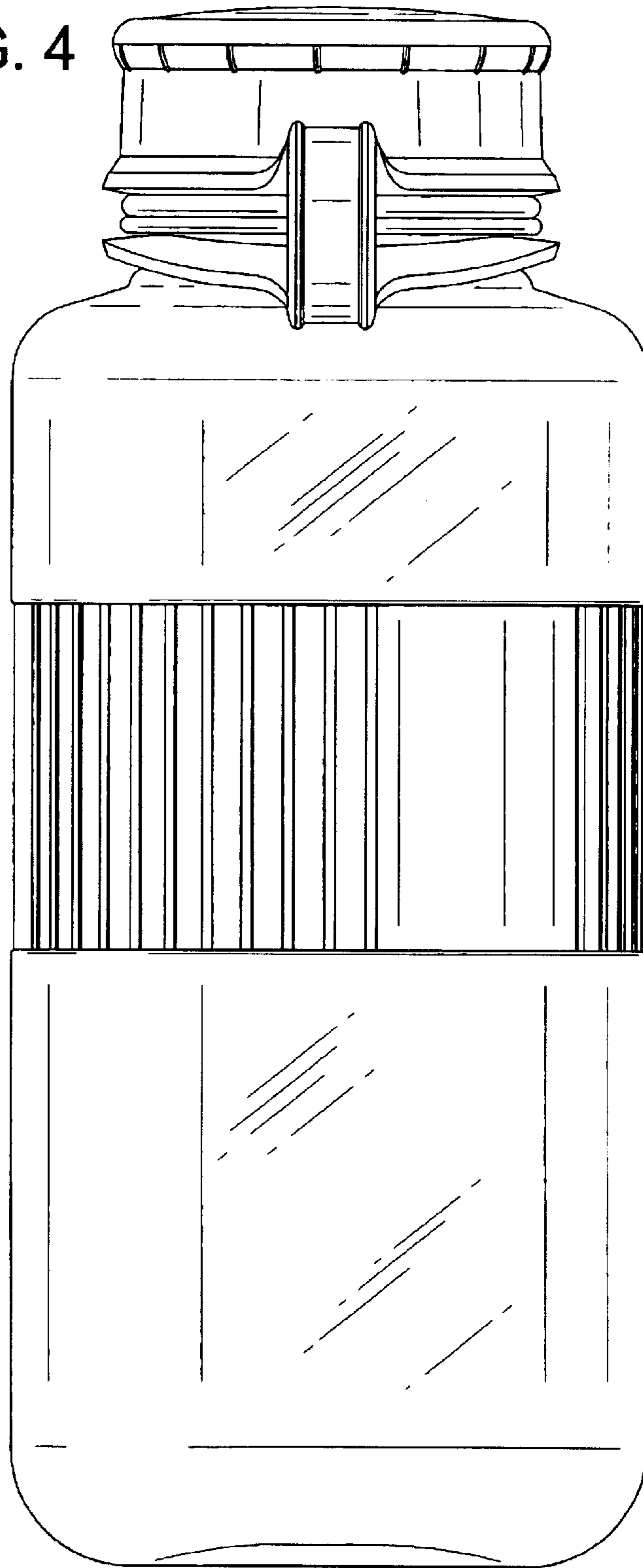

FIG. 5

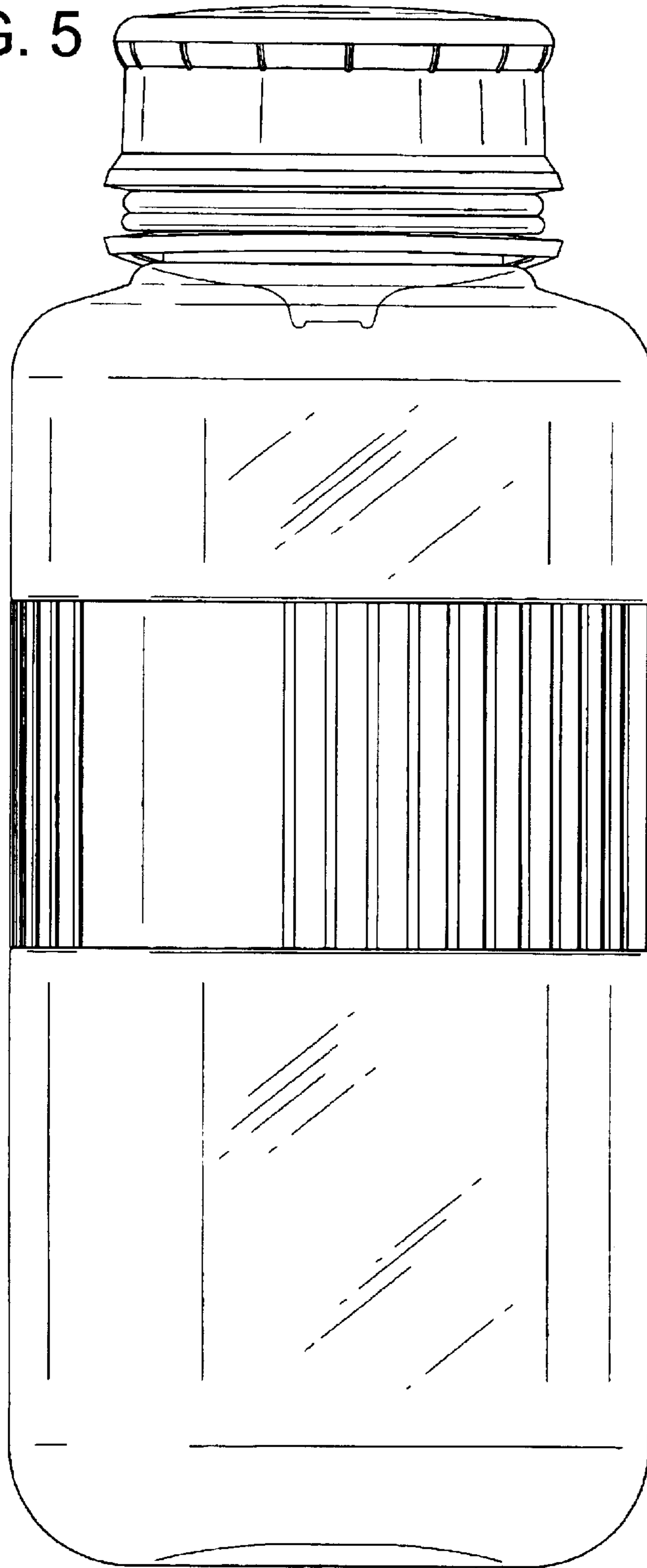



FIG. 6

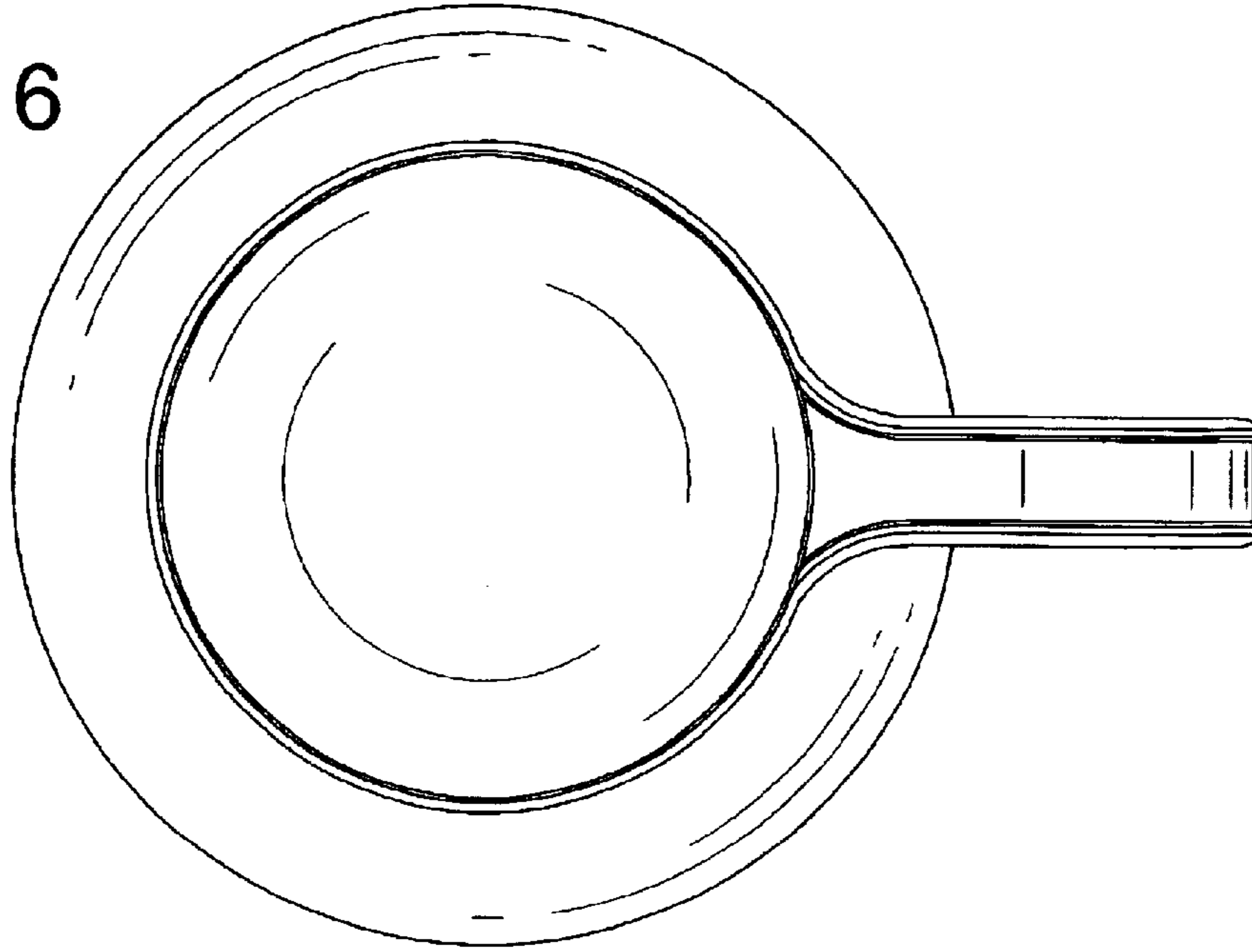

FIG. 7

