



US00D512863S

(12) **United States Design Patent**
Bowes et al.

(10) **Patent No.:** **US D512,863 S**
(45) **Date of Patent:** **** Dec. 20, 2005**

(54) **FLUID DISPENSER**

(76) Inventors: **John Kenneth Bowes**, 39 Leaside Drive, St. Catharines, Ontario (CA), L2M 4G3; **Kevin Thomas Lightfoot**, 129 Speyside Drive, Oakville, Ontario (CA), L6L 5Y1

(**) **Term:** **14 Years**

(21) **Appl. No.:** **29/213,690**

(22) **Filed:** **Sep. 22, 2004**

(30) **Foreign Application Priority Data**

Aug. 20, 2004 (CA) 108114

(51) **LOC (6) Cl.** **23-02**

(52) **U.S. Cl.** **D6/545**

(58) **Field of Search** D6/542-545; 222/92, 222/105, 173, 180; 221/282-283; 206/77.1

(56) **References Cited**

U.S. PATENT DOCUMENTS

D338,585 S * 8/1993 Bell et al. D6/545
D350,665 S 9/1994 Ophardt
D378,035 S 2/1997 Ophardt

D473,087 S * 4/2003 Chen D6/545
D479,422 S * 9/2003 Ciavarella et al. D6/545
D493,647 S 8/2004 Bowes
D503,576 S * 4/2005 Reynolds et al. D6/545

* cited by examiner

Primary Examiner—Brian N Vinson

(74) *Attorney, Agent, or Firm*—Riches, McKenzie & Herbert

(57) **CLAIM**

We claim the ornamental design for a fluid dispenser, as shown.

DESCRIPTION

FIG. 1 is a perspective view of the dispenser in accordance with this invention;

FIG. 2 is a front view of the dispenser in FIG. 1;

FIG. 3 is a left side view of the dispenser in FIG. 1;

FIG. 4 is a right side view of the dispenser in FIG. 1;

FIG. 5 is a back view of the dispenser of FIG. 1;

FIG. 6 is a top view of the dispenser of FIG. 1; and,

FIG. 7 is a bottom view of the dispenser of FIG. 1.

1 Claim, 4 Drawing Sheets

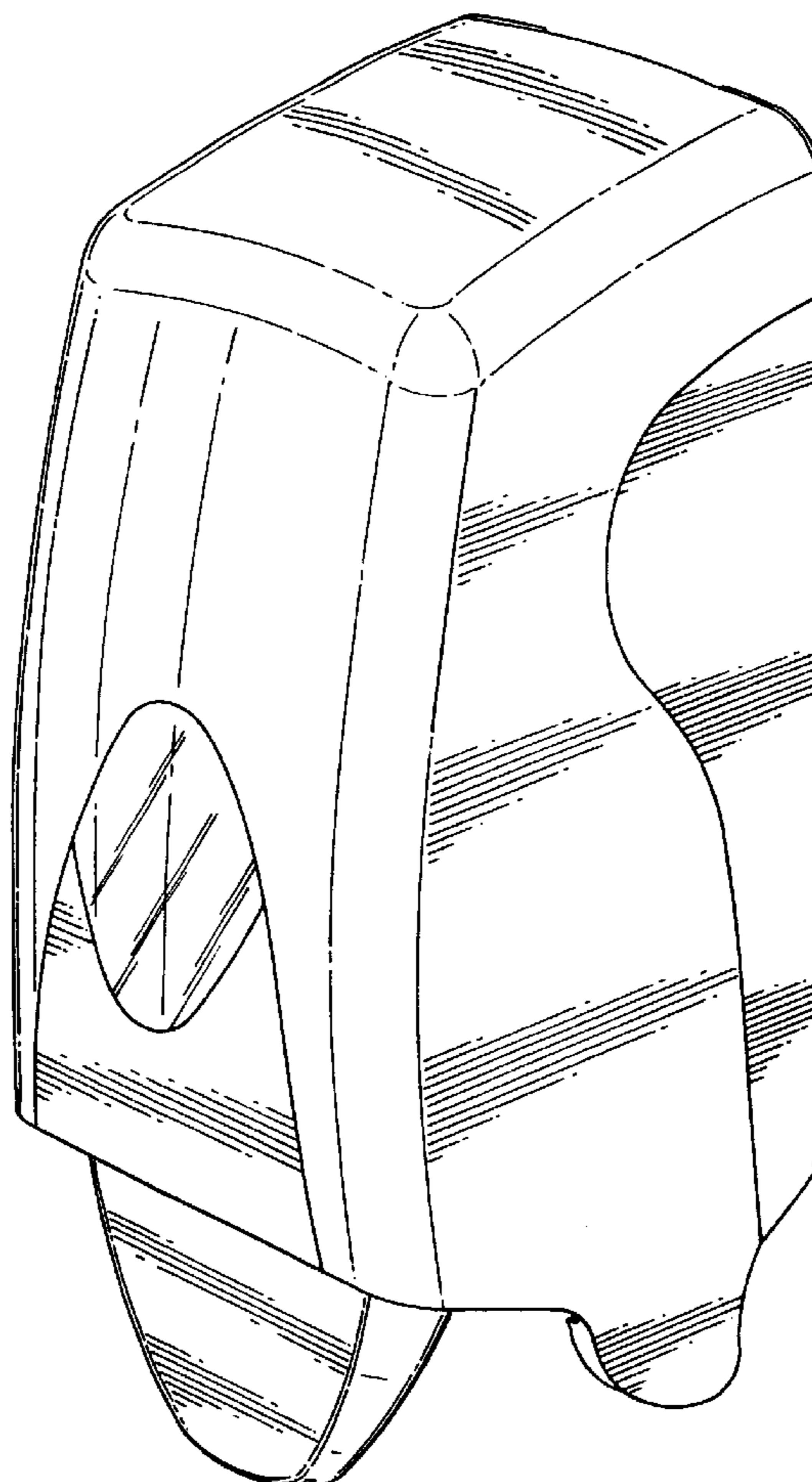

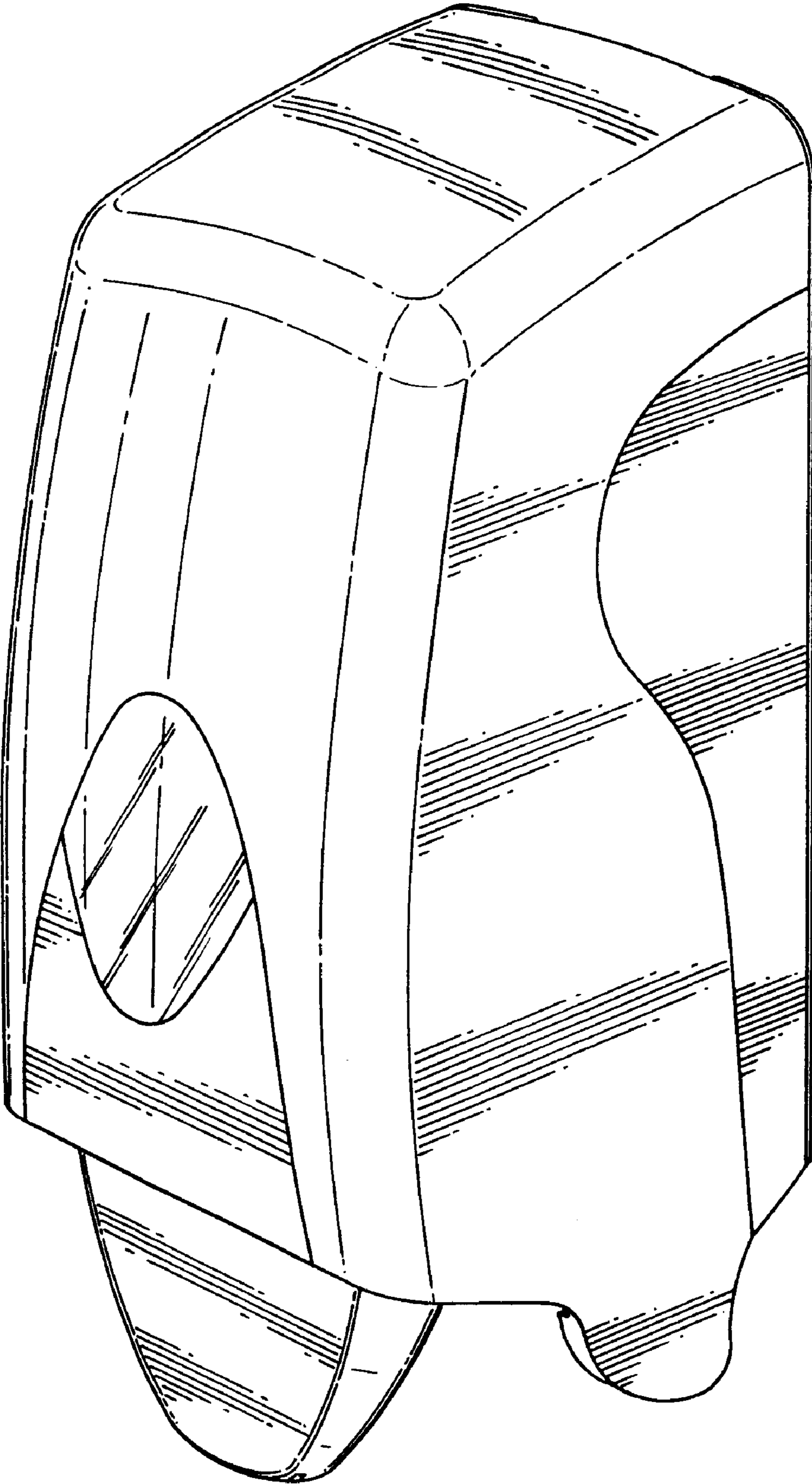

FIG. 1.

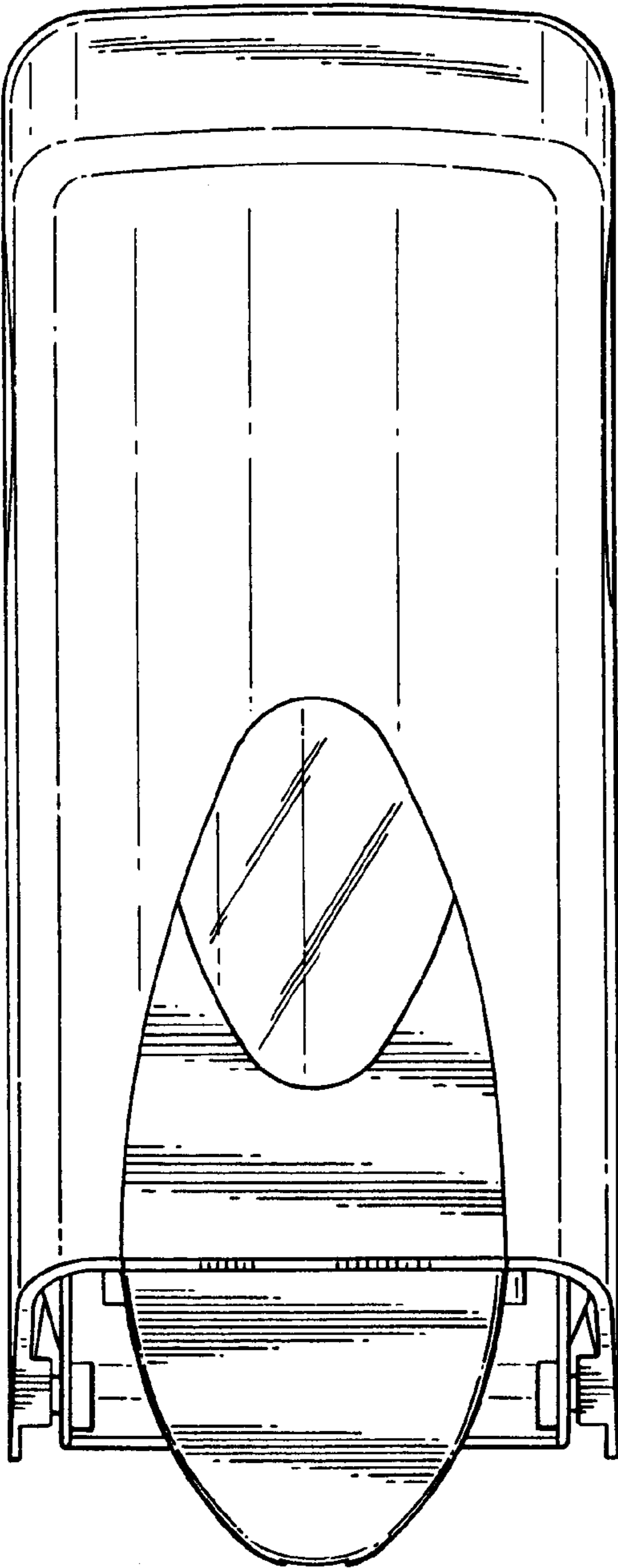

FIG. 2.

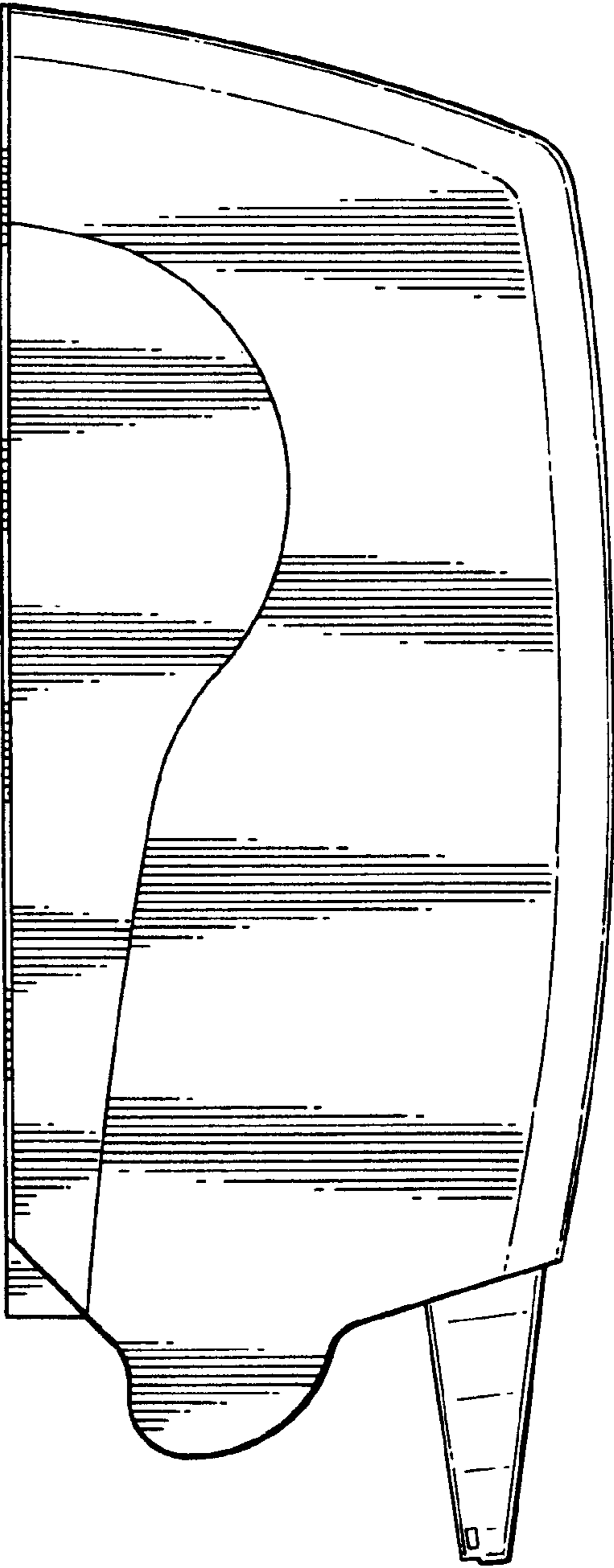

FIG. 3.

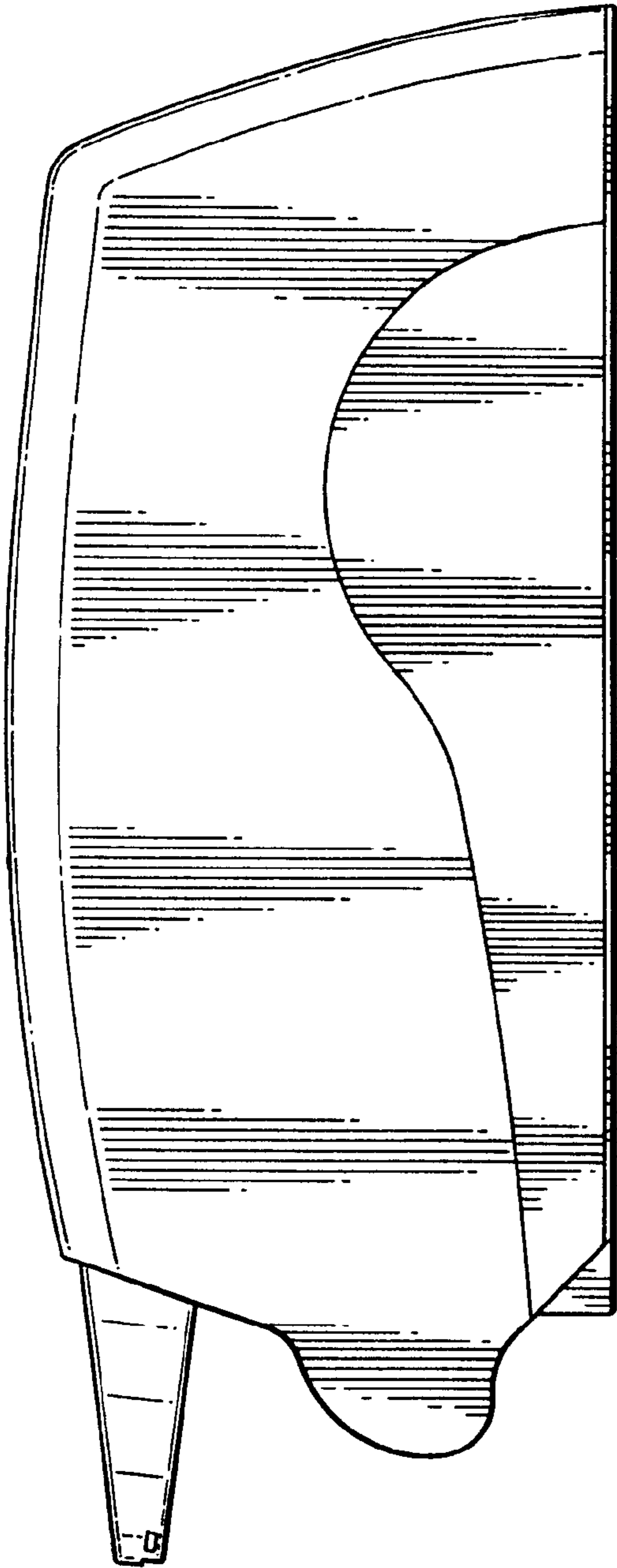

FIG. 4.

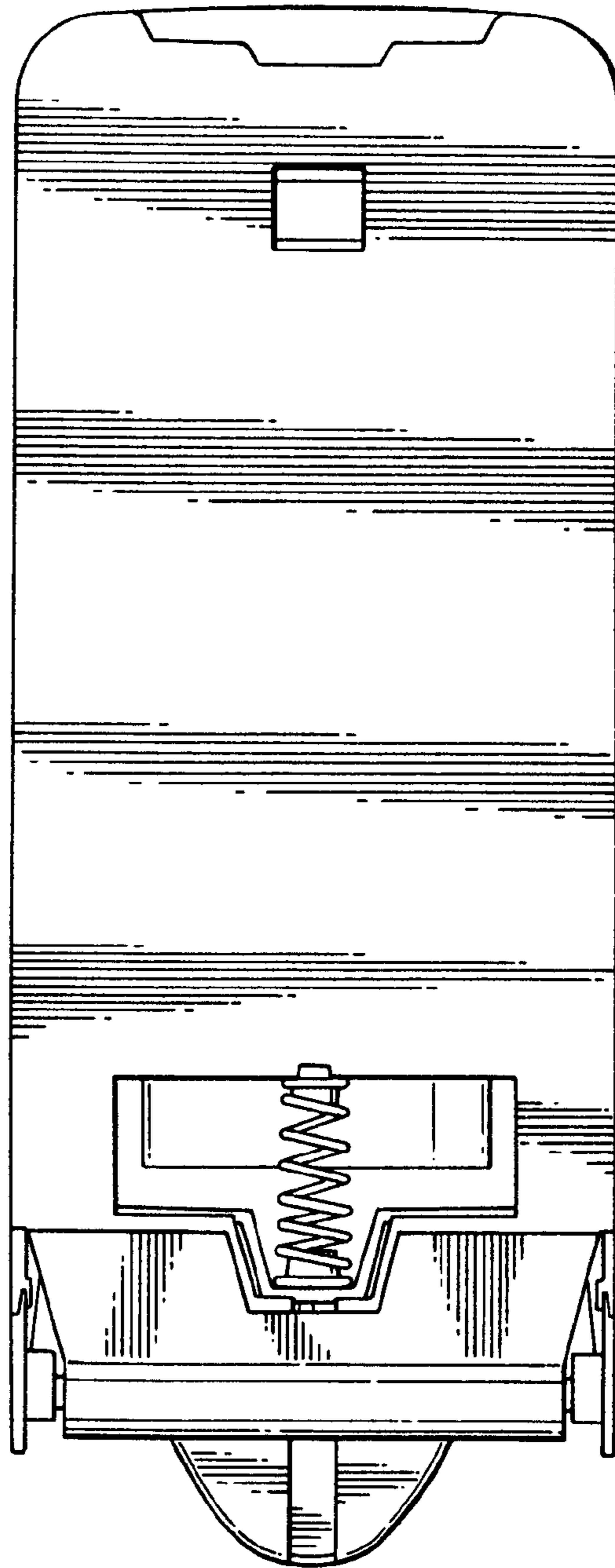

FIG. 5.

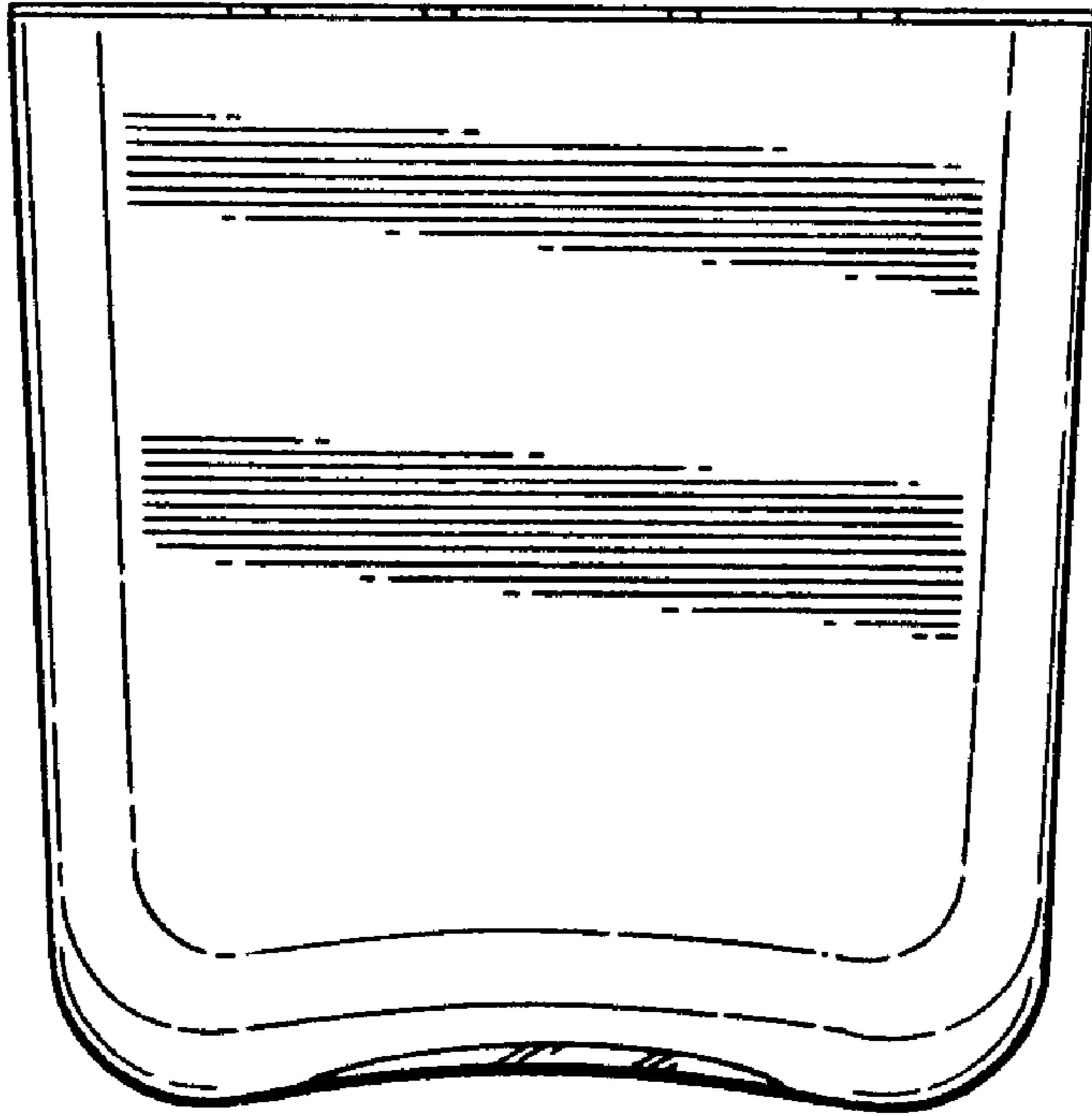

FIG. 6.

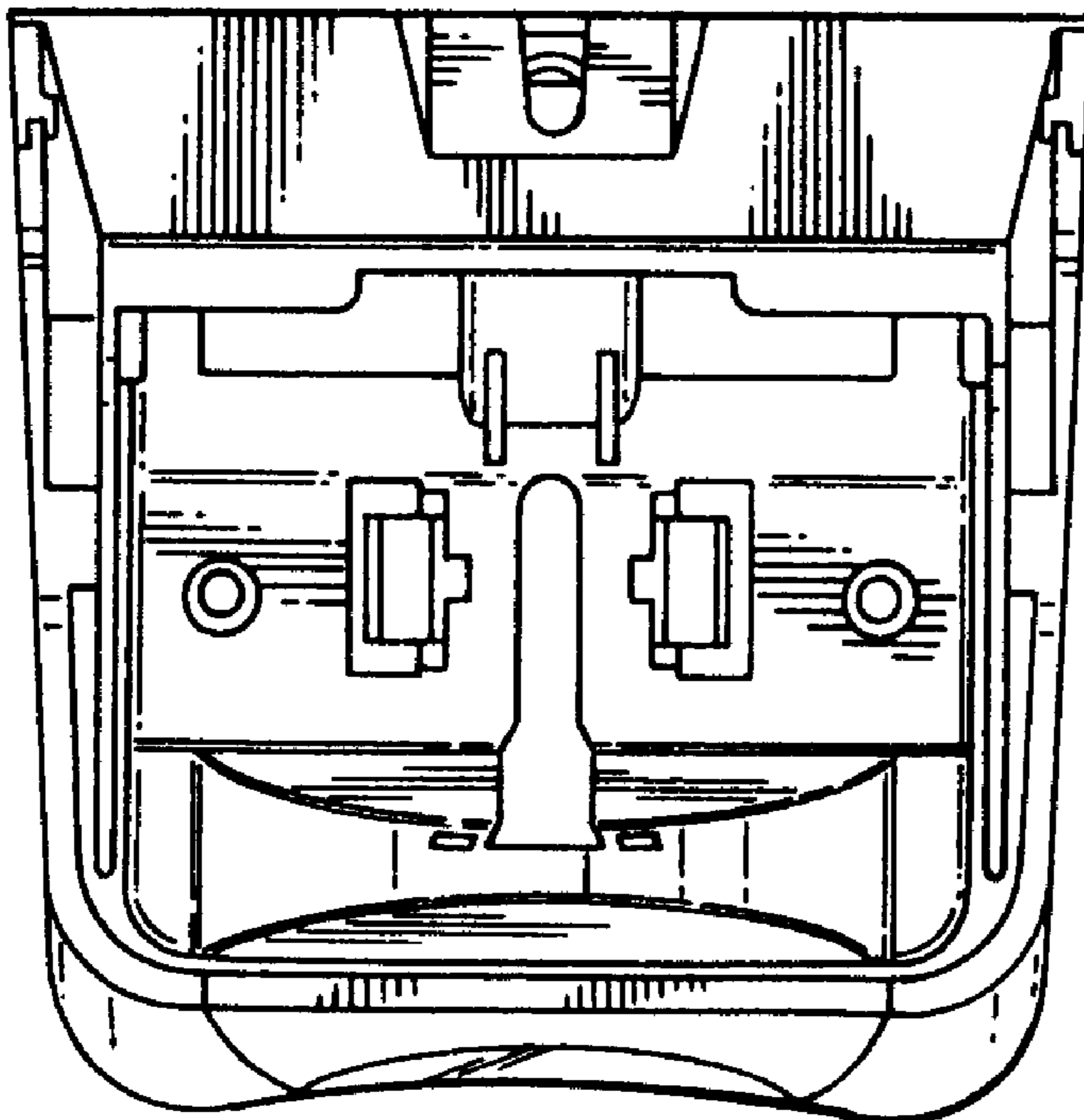

FIG. 7.