



US00D512762S

(12) **United States Design Patent**  
**Comerford et al.**

(10) **Patent No.:** **US D512,762 S**  
(45) **Date of Patent:** **\*\* Dec. 13, 2005**

(54) **HUNTING DECOY**

6,016,771 A \* 1/2000 Baiera et al. .... 119/708  
D473,979 S \* 4/2003 Schwartz et al. .... D30/160

(76) Inventors: **Paul H. Comerford**, 38073 Augusta Dr., Murrieta, CA (US) 92563; **George W. Brint**, Advanced Decoy Research, Inc., 3760 Forrest Hill Rd., Bolivar, TN (US) 38008

\* cited by examiner

*Primary Examiner*—Catherine R. Oliver  
(74) *Attorney, Agent, or Firm*—Loyal McKinney Hanson

(\*\*) **Term:** **14 Years**

(57) **CLAIM**

We claim the ornamental design for a hunting decoy, as shown.

(21) **Appl. No.:** **29/211,337**

(22) **Filed:** **Aug. 13, 2004**

**DESCRIPTION**

(51) **LOC (6) Cl.** ..... **22-05**

(52) **U.S. Cl.** ..... **D22/125**

(58) **Field of Search** ..... D22/125; 43/2-3;  
119/706-711; D21/467

FIG. 1 is a front, top and left side perspective view of the hunting decoy showing our new design;  
FIG. 2 is a front elevation view thereof;  
FIG. 3 is a left side elevation view thereof;  
FIG. 4 is a top plan view thereof;  
FIG. 5 is a rear elevation view thereof;  
FIG. 6 is a right side elevation view thereof; and,  
FIG. 7 is a bottom plan view.

(56) **References Cited**

**U.S. PATENT DOCUMENTS**

4,517,922 A \* 5/1985 Lind ..... 119/708  
5,875,737 A \* 3/1999 Boshears ..... 119/706

**1 Claim, 6 Drawing Sheets**

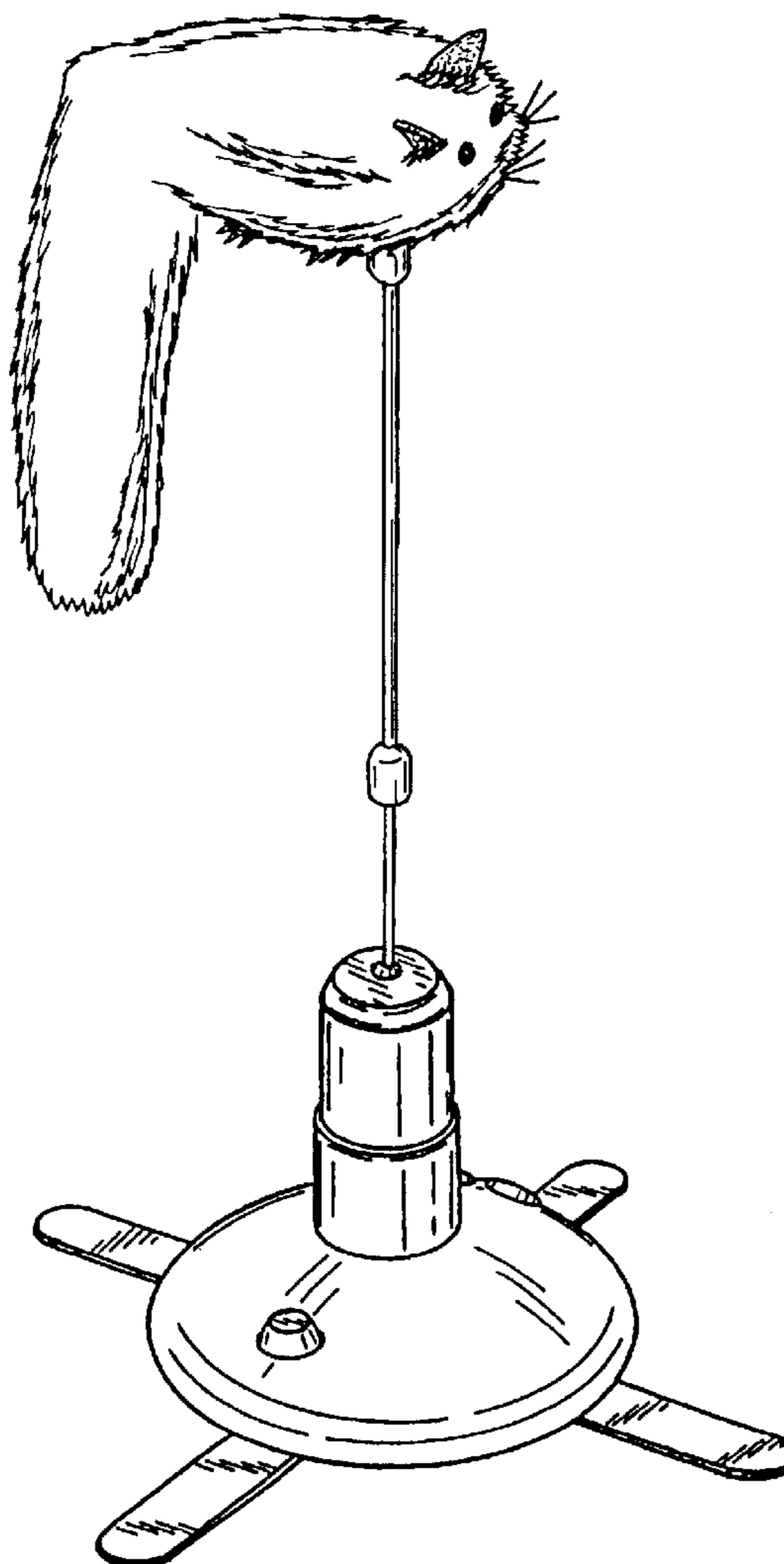

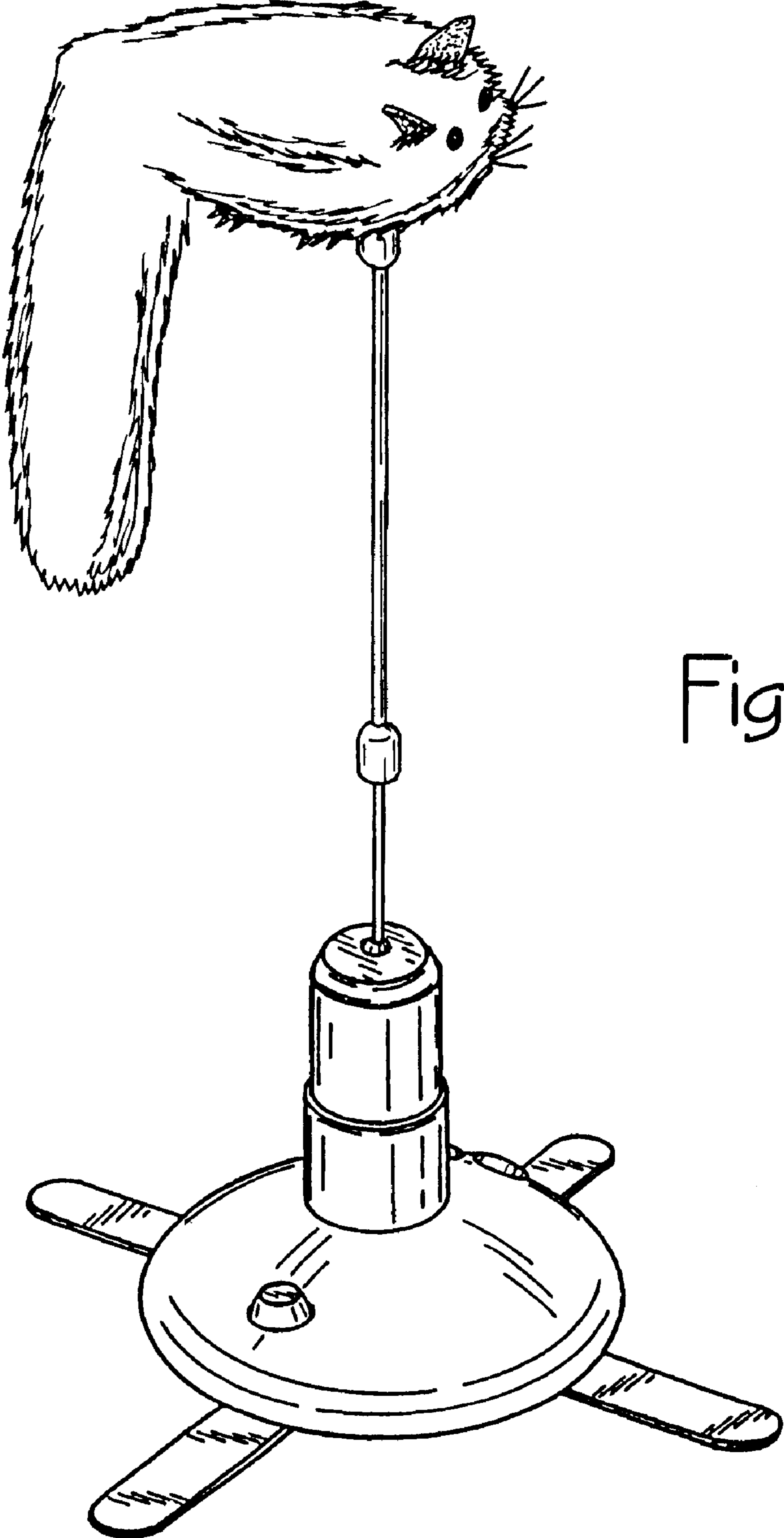

Fig. 1

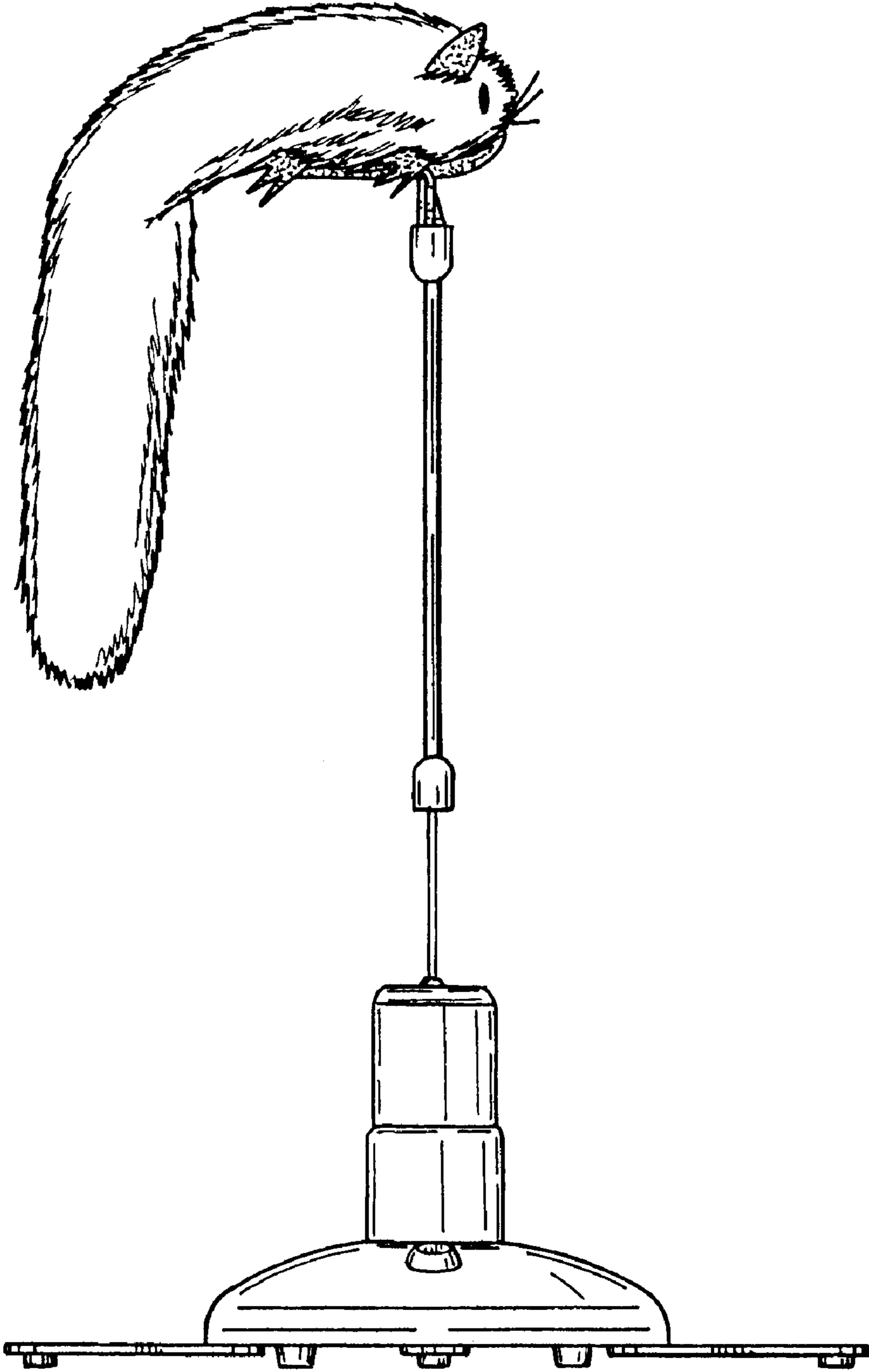

Fig. 2

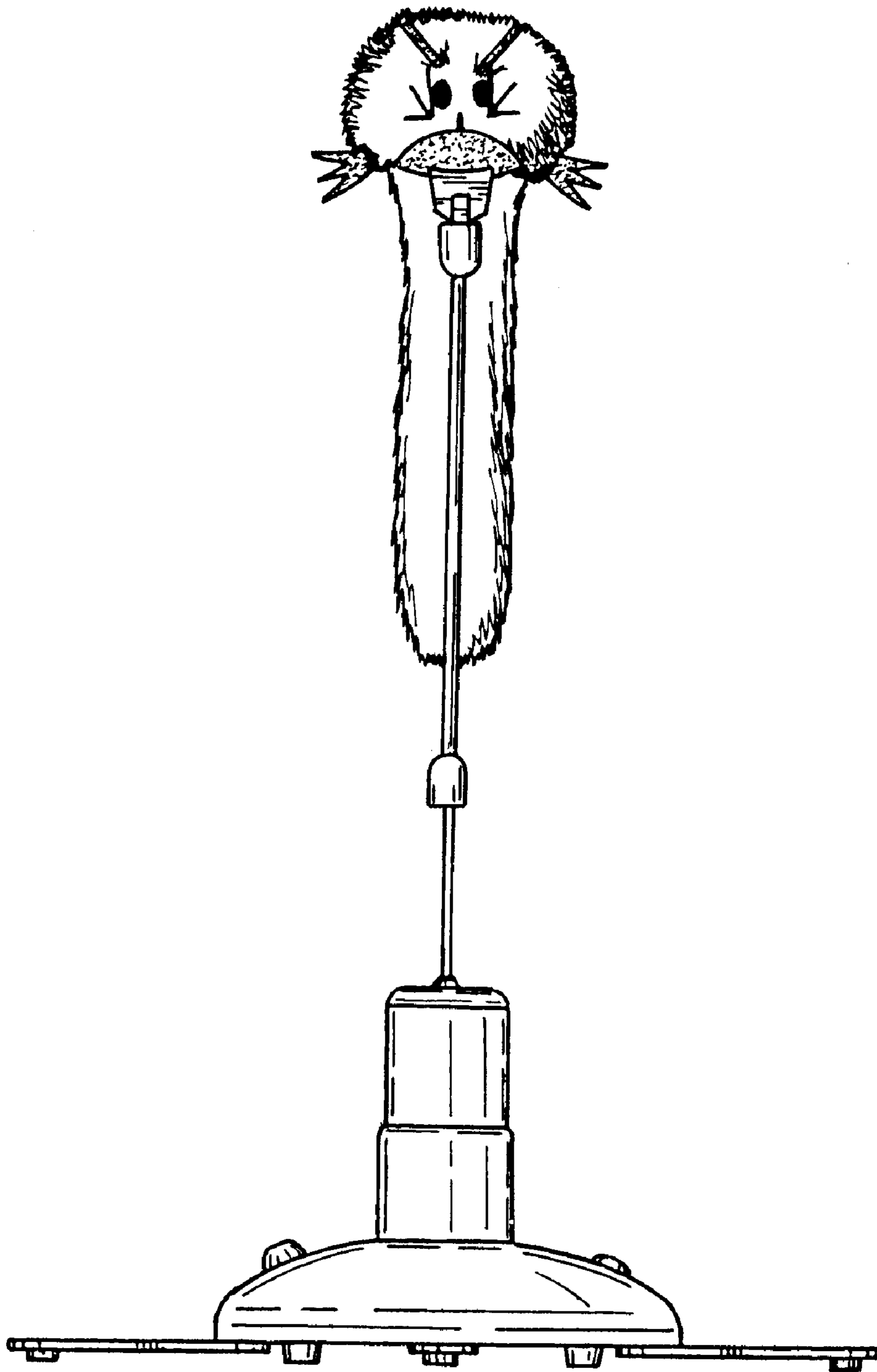

Fig. 3

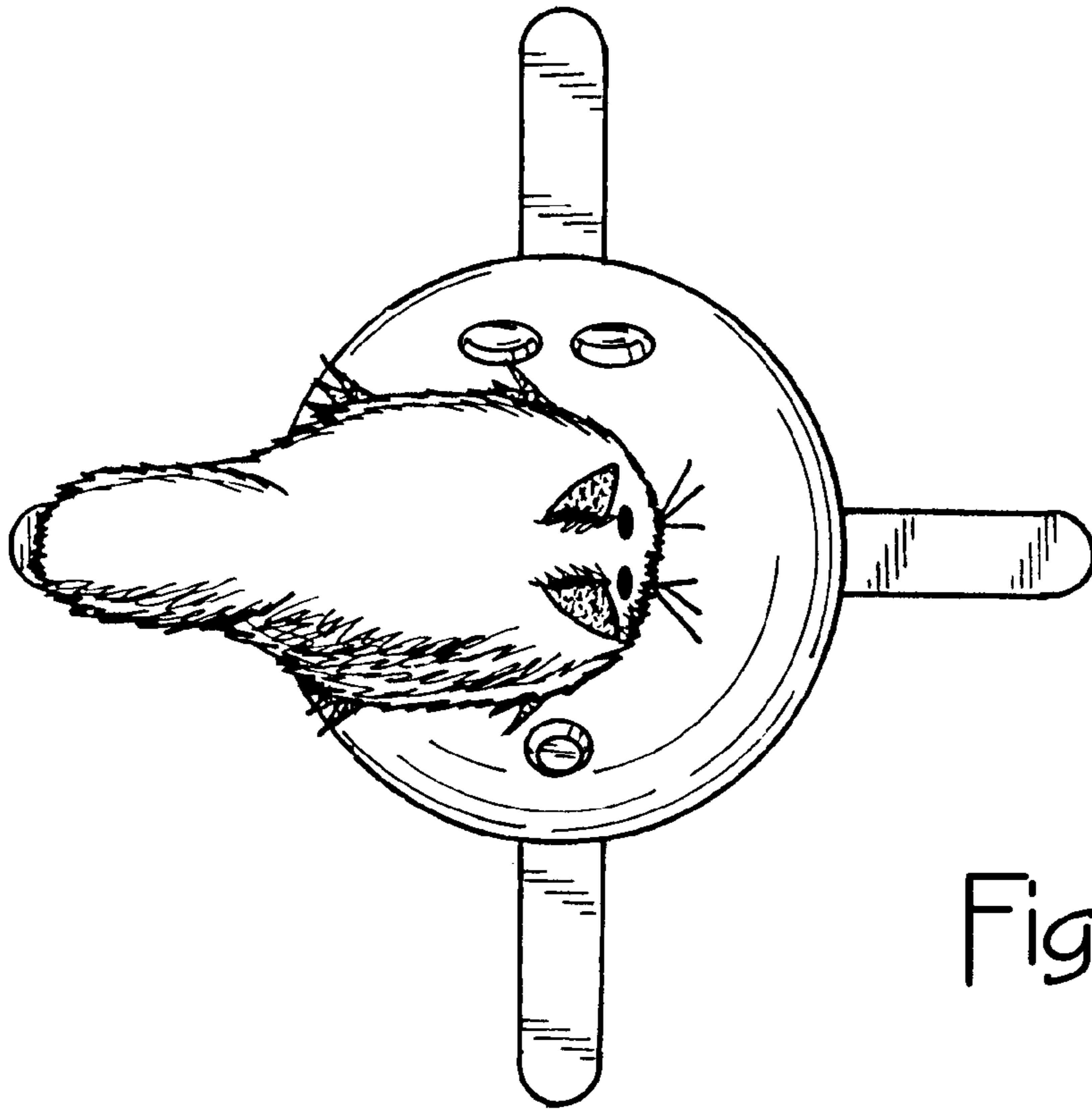

Fig. 4

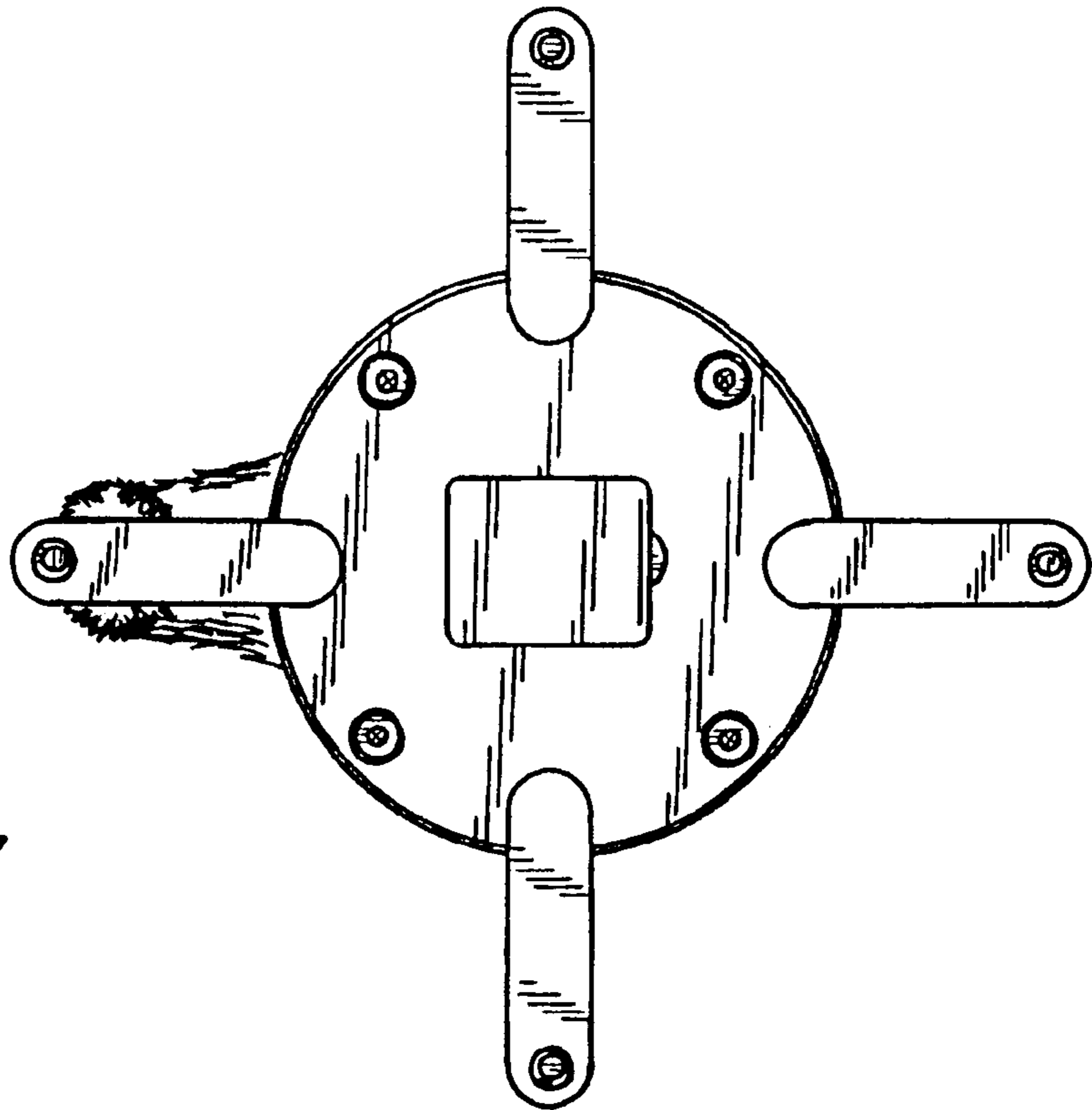

Fig. 7

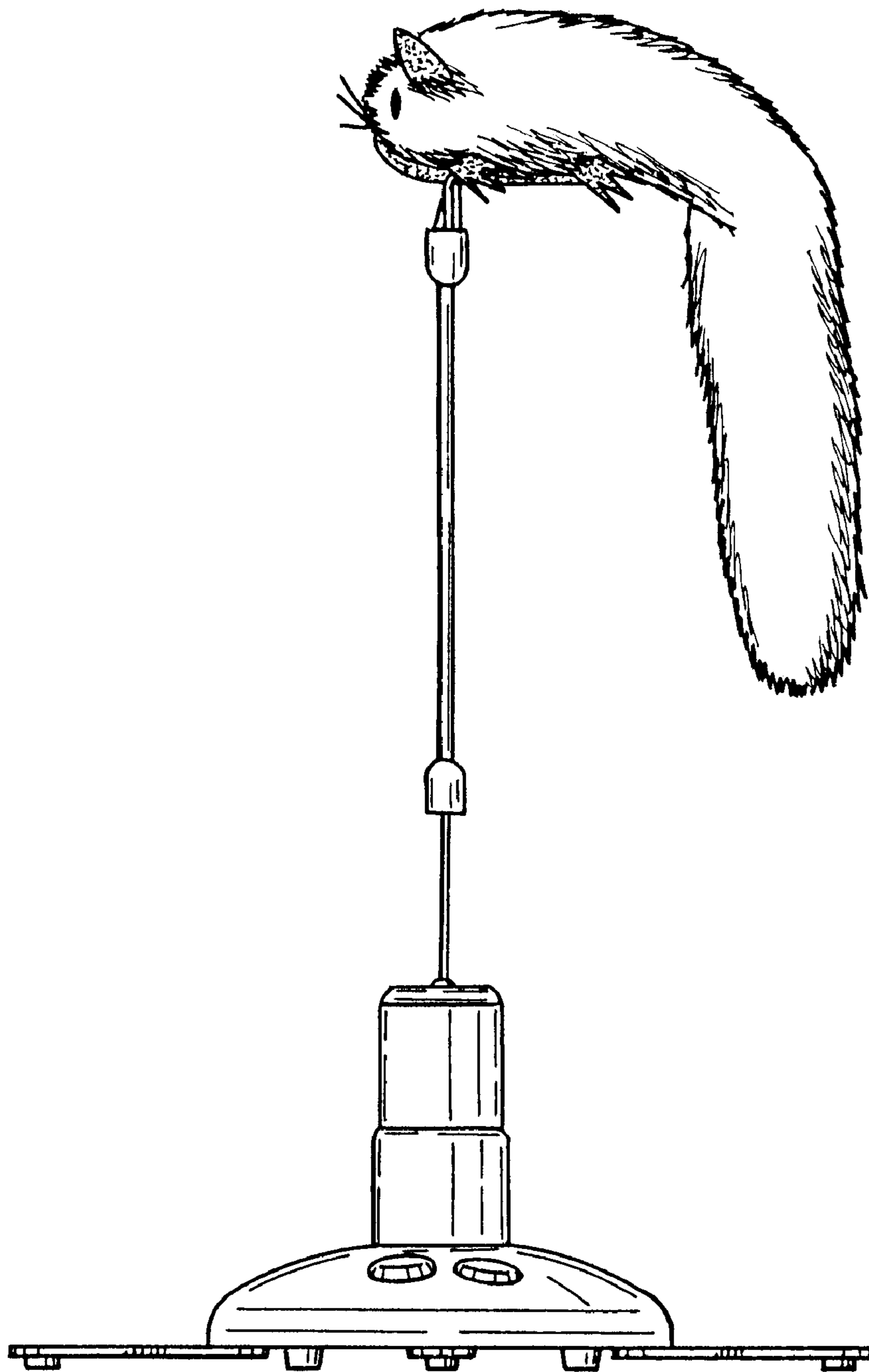

Fig. 5

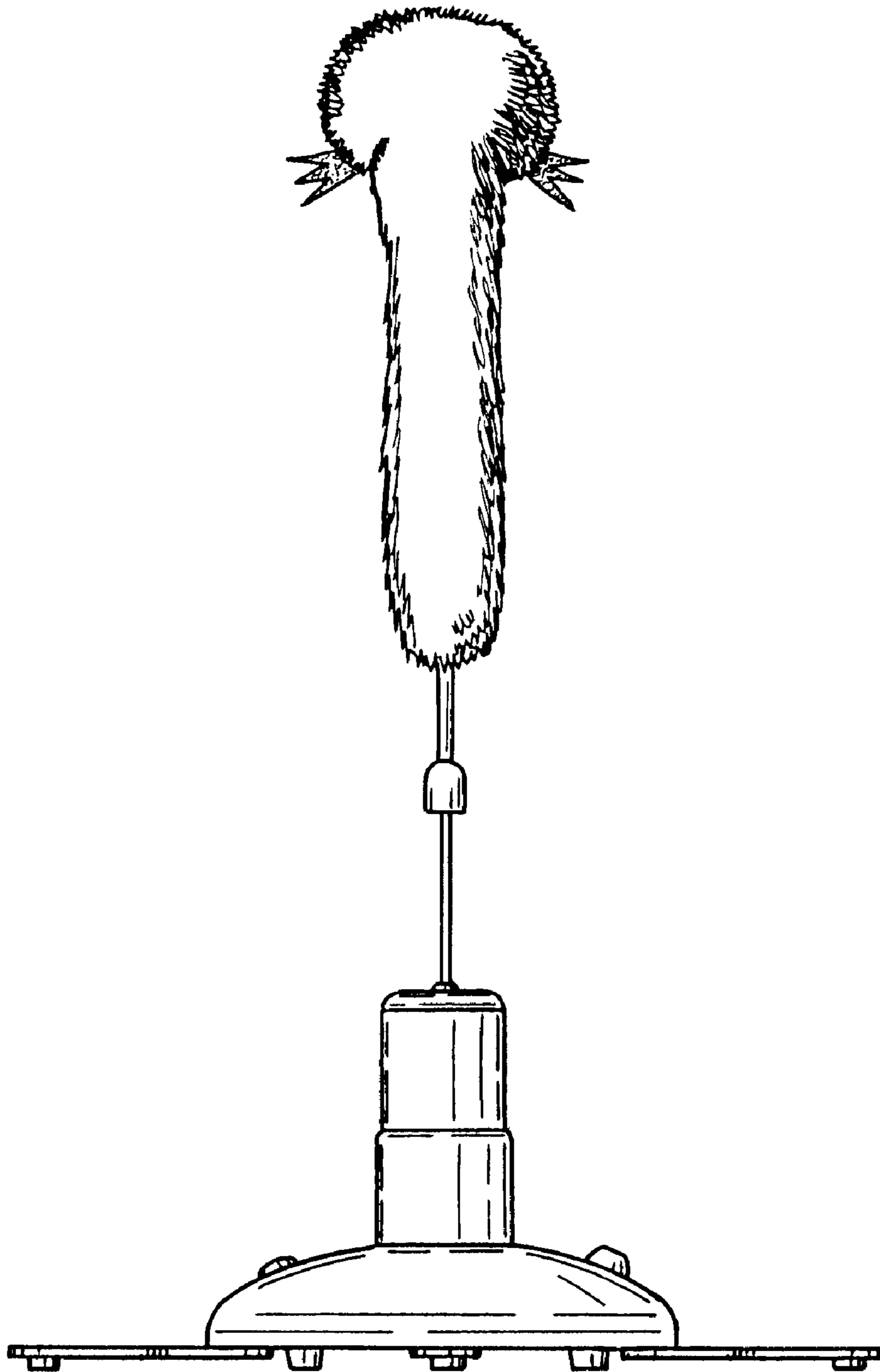

Fig. 6