



US00D512743S

(12) **United States Design Patent** (10) **Patent No.:** **US D512,743 S**
Killinger et al. (45) **Date of Patent:** **** *Dec. 13, 2005**

(54) **HOLDER**
(75) Inventors: **Timothy D. Killinger**, Plainfield, IL (US); **Matthew G. Lerch**, Chicago, IL (US); **Aaron W. Smith**, Plainfield, IL (US); **Giberto Cavada, Jr.**, Melrose Park, IL (US); **Melanie Lyn Conklin**, Chicago, IL (US)
(73) Assignee: **Rubbermaid Incorporated**, Fairlaw, OH (US)
(*) Notice: This patent is subject to a terminal disclaimer.
(**) Term: **14 Years**

4,320,837 A 3/1982 Carroll et al. 206/505
D310,925 S 10/1990 Mervar et al. D6/567
D314,215 S 1/1991 Hawes, Jr. et al. D19/90
5,036,988 A * 8/1991 Rouire 211/42
D335,996 S 6/1993 Evenson D6/553
D381,691 S * 7/1997 Miyake D19/90
D385,921 S * 11/1997 Tisbo D19/90
D390,606 S * 2/1998 Cheris et al. D19/90
D393,005 S 3/1998 Devito D19/92
D400,926 S 11/1998 Stravitz D19/90
D420,051 S 2/2000 Conley et al. D19/90
D444,816 S 7/2001 Stravitz D19/90
6,352,162 B1 * 3/2002 Yang et al. 211/43
D468,352 S * 1/2003 Chen D19/34.1
D498,263 S * 11/2004 Goodman et al. D19/90

* cited by examiner

(21) Appl. No.: **29/212,026**
(22) Filed: **Aug. 25, 2004**

Primary Examiner—Jeffrey Asch
Assistant Examiner—Elizabeth Albert
(74) *Attorney, Agent, or Firm*—Marshall, Gerstein & Borun LLP

Related U.S. Application Data

(63) Continuation of application No. 29/202,743, filed on Apr. 2, 2004, now Pat. No. Des. 504,467.

(57) **CLAIM**

The ornamental design for a “holder,” as shown and described.

(51) **LOC (6) Cl.** **19-02**
(52) **U.S. Cl.** **D19/90**
(58) **Field of Search** D19/65, 75, 78, D19/86, 90, 91, 95, 99, 100; D6/475; 211/10, 11, 13.1, 50, 113, 184; 229/178–182, 191, 198, 198.3; 206/425; 312/348.1; D9/432, 433

DESCRIPTION

FIG. 1 is a perspective view of a holder showing our new design;
FIG. 2 is a front elevational view of the holder of FIG. 1;
FIG. 3 is a top plan view of the holder of FIG. 1;
FIG. 4 is a left side elevational view of the holder of FIG. 1, the right side elevational view being a mirror image thereof;
FIG. 5 is a bottom plan view of the holder of FIG. 1;
FIG. 6 is a rear elevational view of the holder of FIG. 1; and,
FIG. 7 is another perspective view showing our new design.
The dashed lines are for illustrative purposes only and form no part of the claimed design.

(56) **References Cited**

U.S. PATENT DOCUMENTS

1,396,910 A * 11/1921 Annable 211/42
1,598,467 A * 8/1926 Weeks 211/43
D231,137 S * 4/1974 Juhlin D19/90
3,934,724 A 1/1976 Johnson 206/507
4,102,453 A 7/1978 Carroll et al. 206/507
4,238,032 A 12/1980 Thurman 206/507

1 Claim, 3 Drawing Sheets

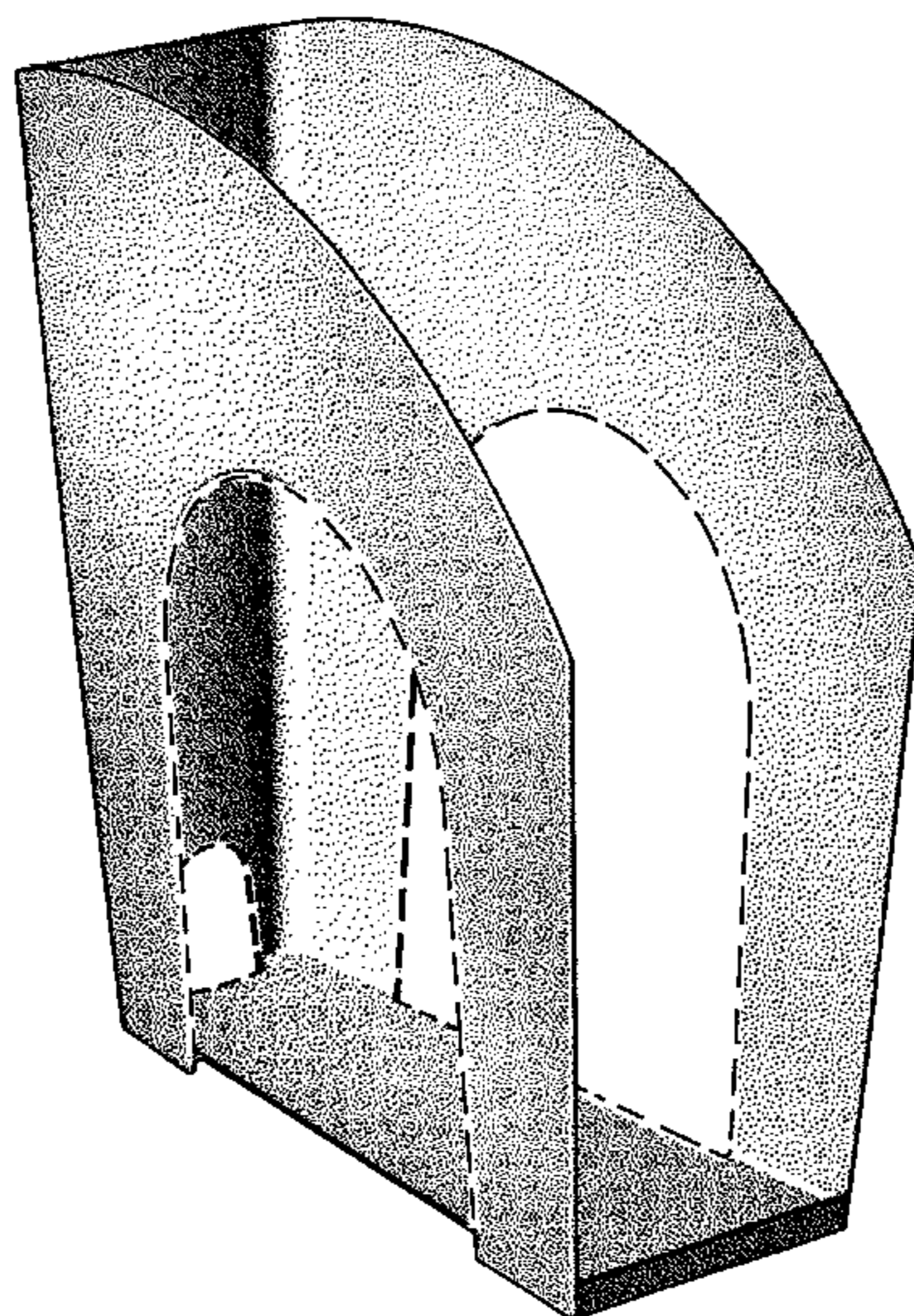

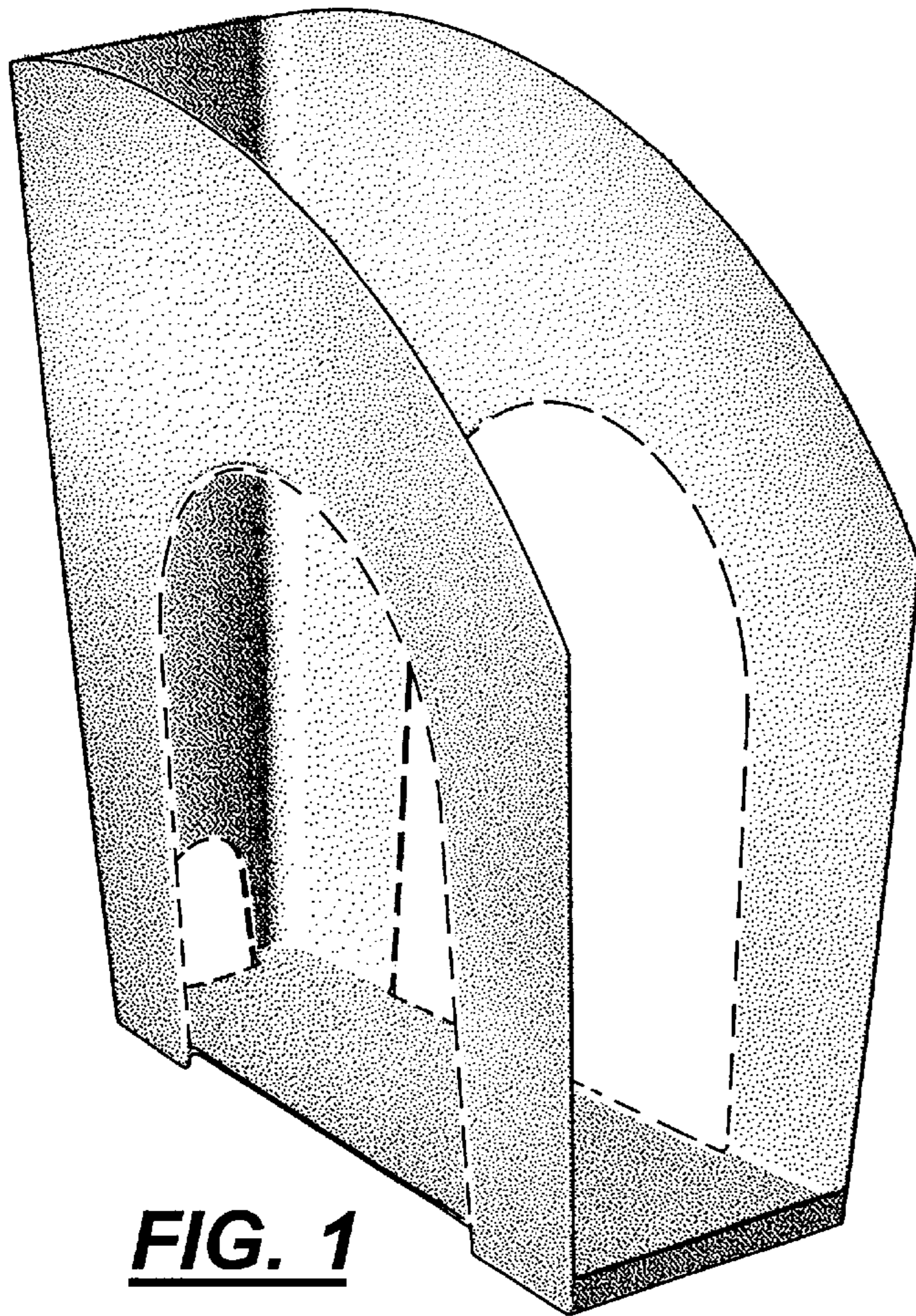

FIG. 1

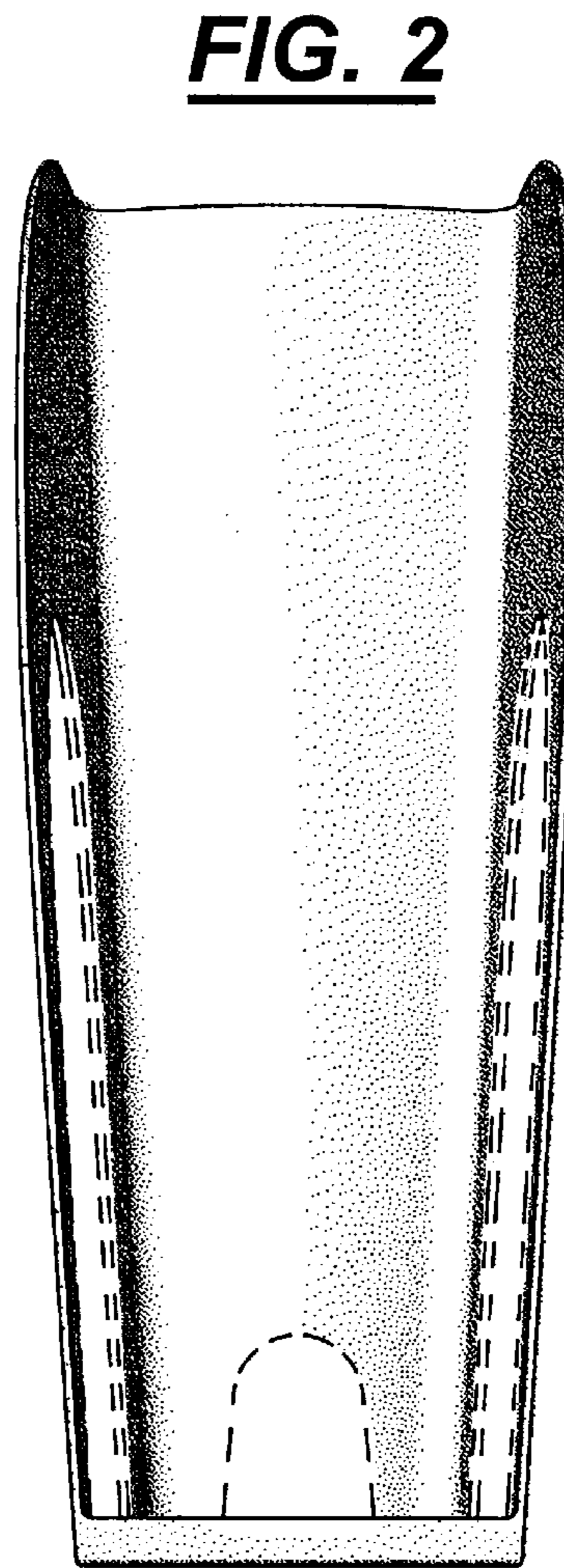

FIG. 2

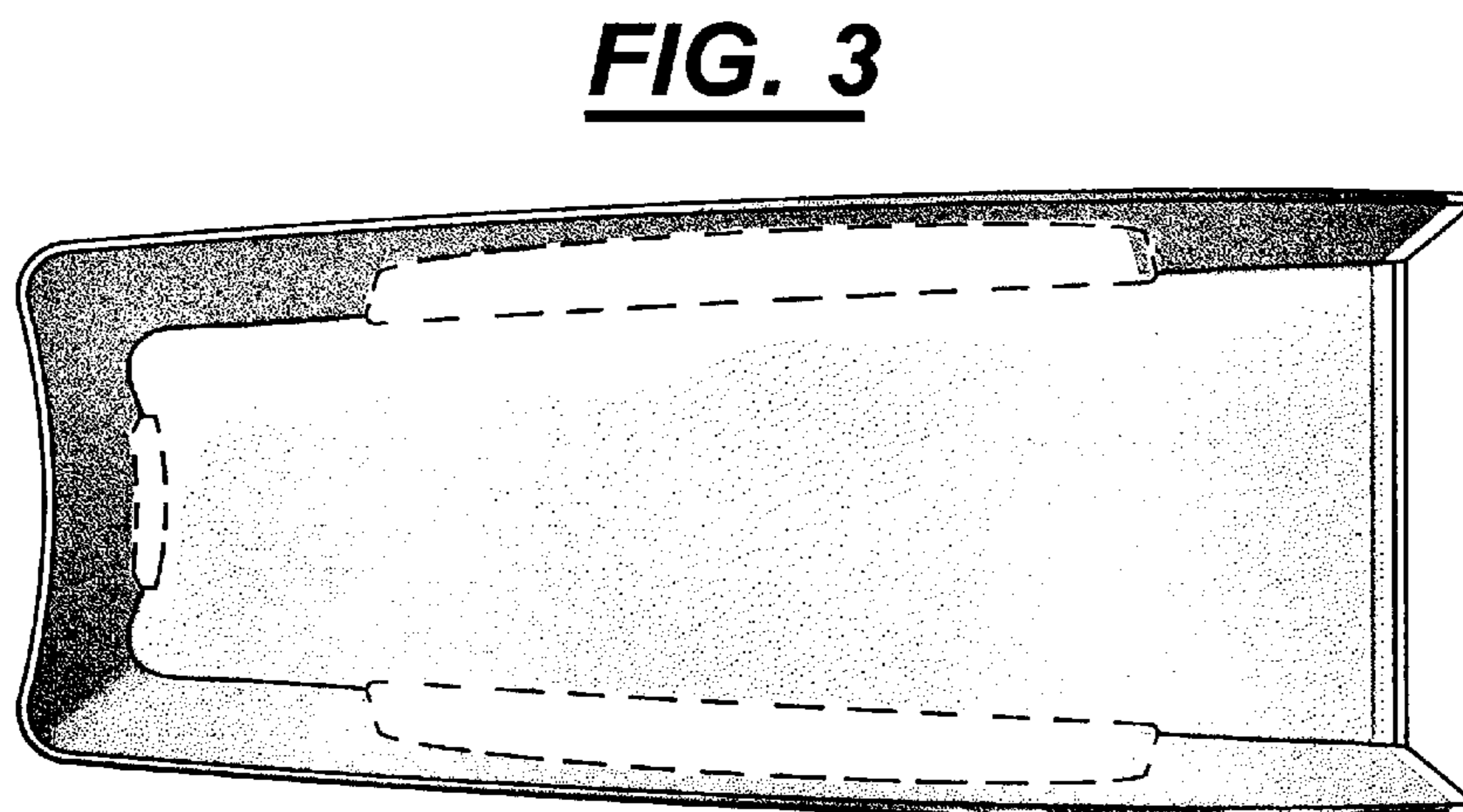

FIG. 3

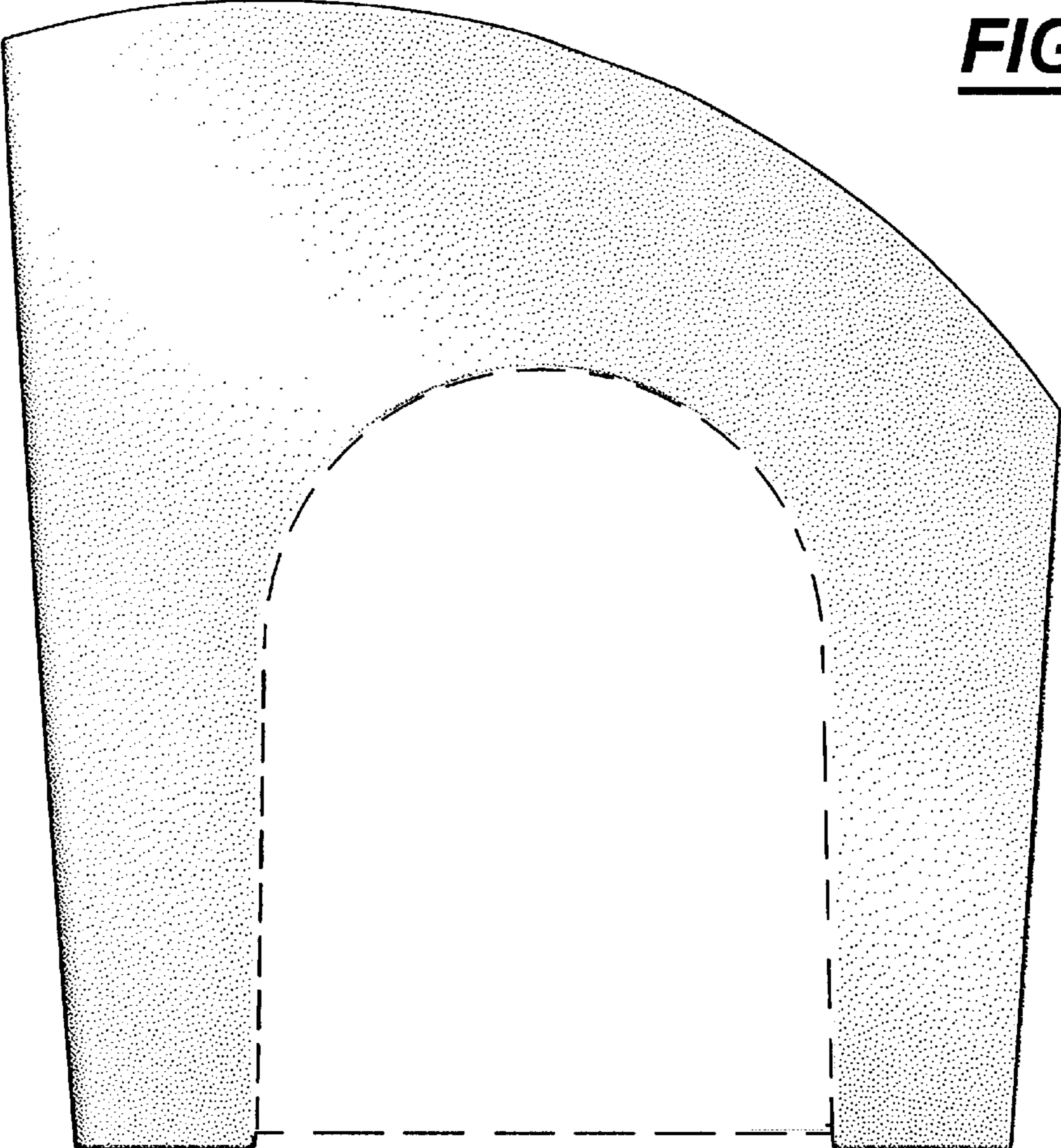
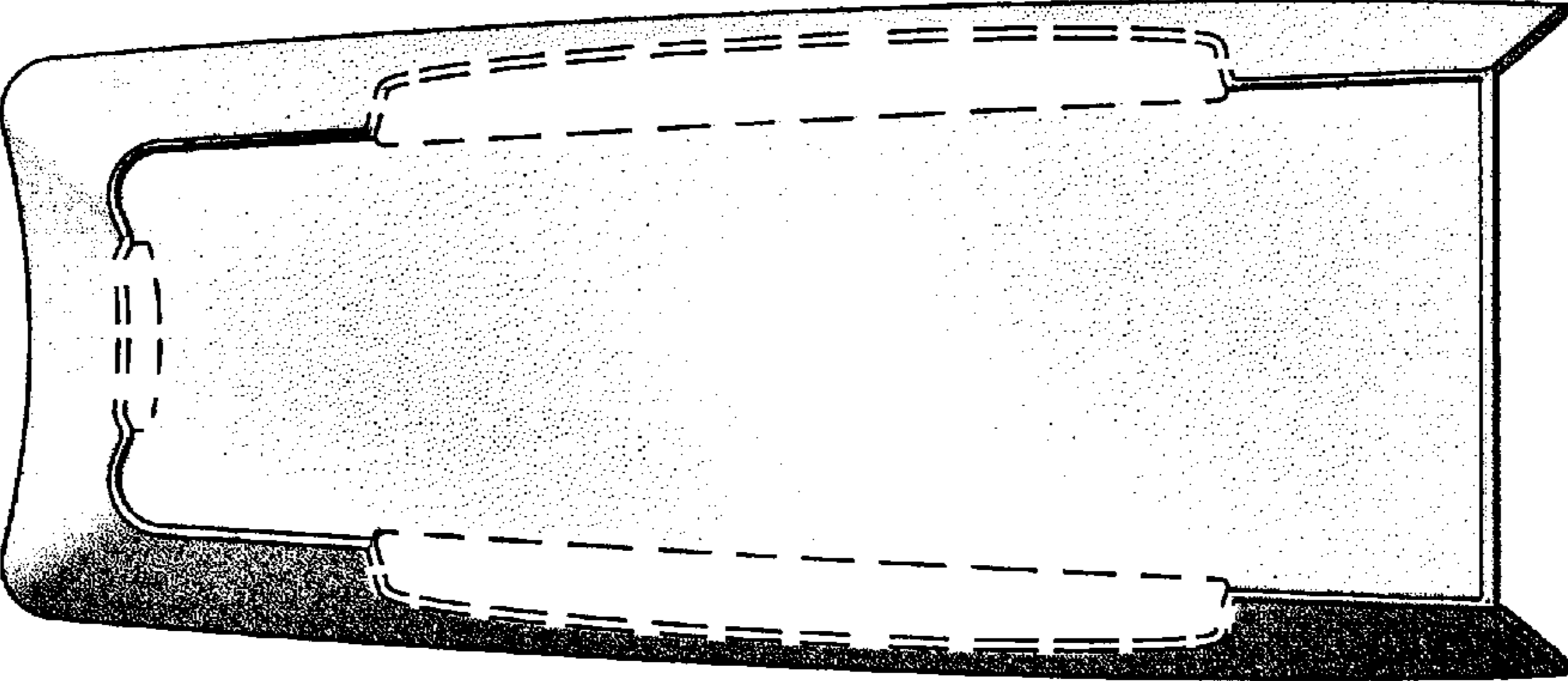

FIG. 4

FIG. 5



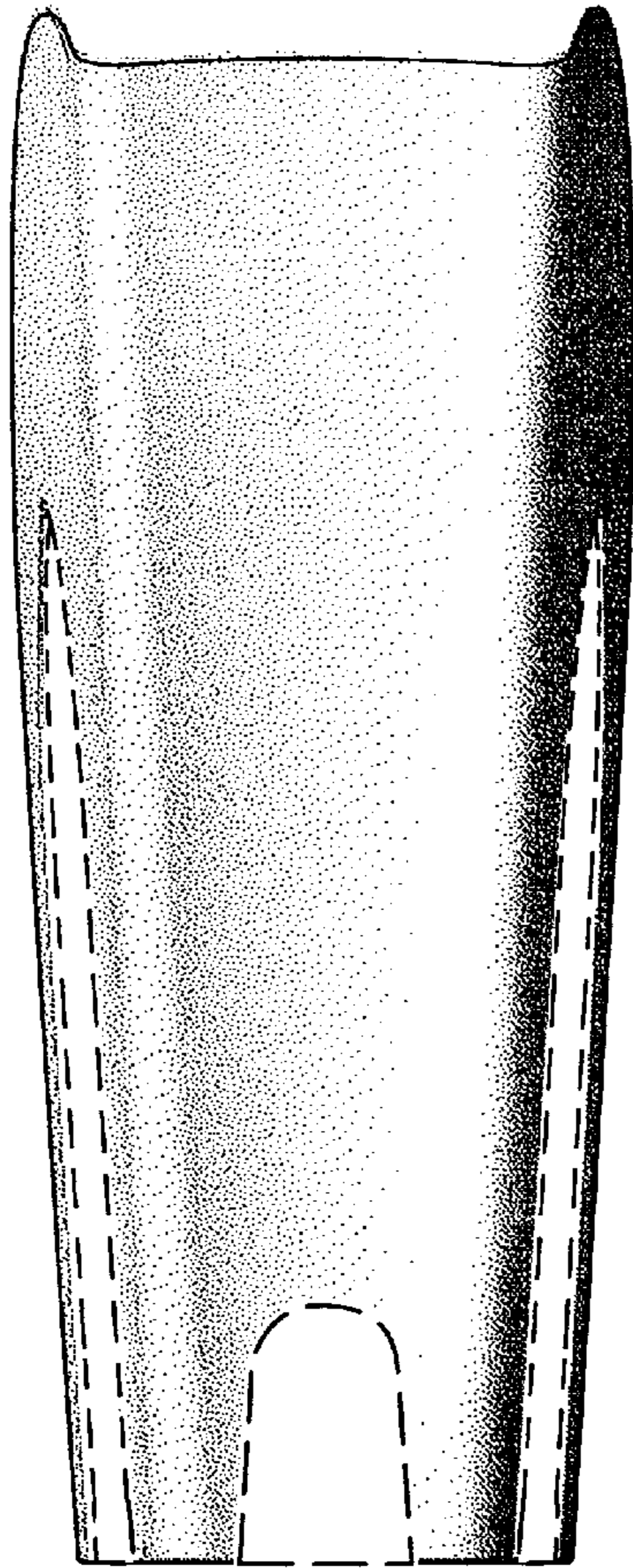

FIG. 6

FIG. 7

