

US00D512721S

(12) **United States Design Patent**  
**Yu et al.**

(10) **Patent No.:** **US D512,721 S**

(45) **Date of Patent:** **\*\* Dec. 13, 2005**

(54) **COMPUTER FRONT BEZEL**

D454,572 S \* 3/2002 Chien et al. .... D14/444  
D468,744 S \* 1/2003 Chien et al. .... D14/444

(75) Inventors: **De-Hai Yu**, Shenzhen (CN); **Chun-Chi Liang**, Tu-Chen (TW); **Yun-Dong Xu**, Shenzhen (CN)

\* cited by examiner

*Primary Examiner*—Freda S. Nunn

(74) *Attorney, Agent, or Firm*—Wei Te Chung

(73) Assignee: **Hon Hai Precision Ind. Co., Ltd.**, Taipei Hsien (TW)

(57) **CLAIM**

(\*\*) Term: **14 Years**

The ornamental design for a computer front bezel, as shown and described.

(21) Appl. No.: **29/212,474**

**DESCRIPTION**

(22) Filed: **Aug. 31, 2004**

FIG. 1 is a perspective view of a computer front bezel of our new design;

(30) **Foreign Application Priority Data**

May 26, 2004 (CN) ..... 200430041607

FIG. 2 is a front elevational view thereof;

(51) **LOC (6) Cl.** ..... **14-02**

FIG. 3 is a rear elevational view thereof;

(52) **U.S. Cl.** ..... **D14/444**

FIG. 4 is a left side elevational view thereof;

(58) **Field of Search** ..... D14/441-446;  
D13/162, 184, 199; 312/223.2; 361/680-686,  
690-696; 369/34.01, 36.01

FIG. 5 is a right side elevational view thereof;

FIG. 6 is a top plan view thereof;

FIG. 7 is a bottom plan view thereof; and,

FIG. 8 is a perspective view thereof being mounted to a computer case and having a plurality of shielding plates attached thereto, wherein the computer case and the shielding plates are shown in broken lines for illustrative purposes only and form no part of the claimed design.

(56) **References Cited**

**U.S. PATENT DOCUMENTS**

5,169,218 A \* 12/1992 Chu ..... 312/223.2  
D439,254 S \* 3/2001 Zhao ..... D14/441

**1 Claim, 6 Drawing Sheets**

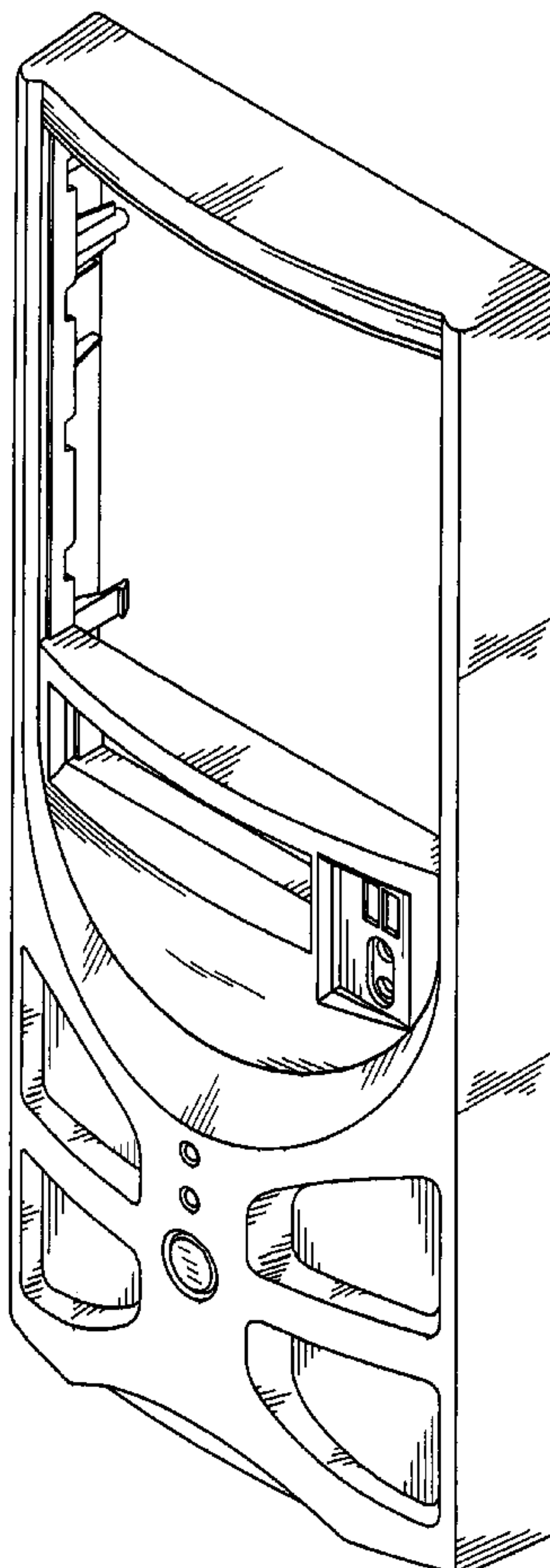

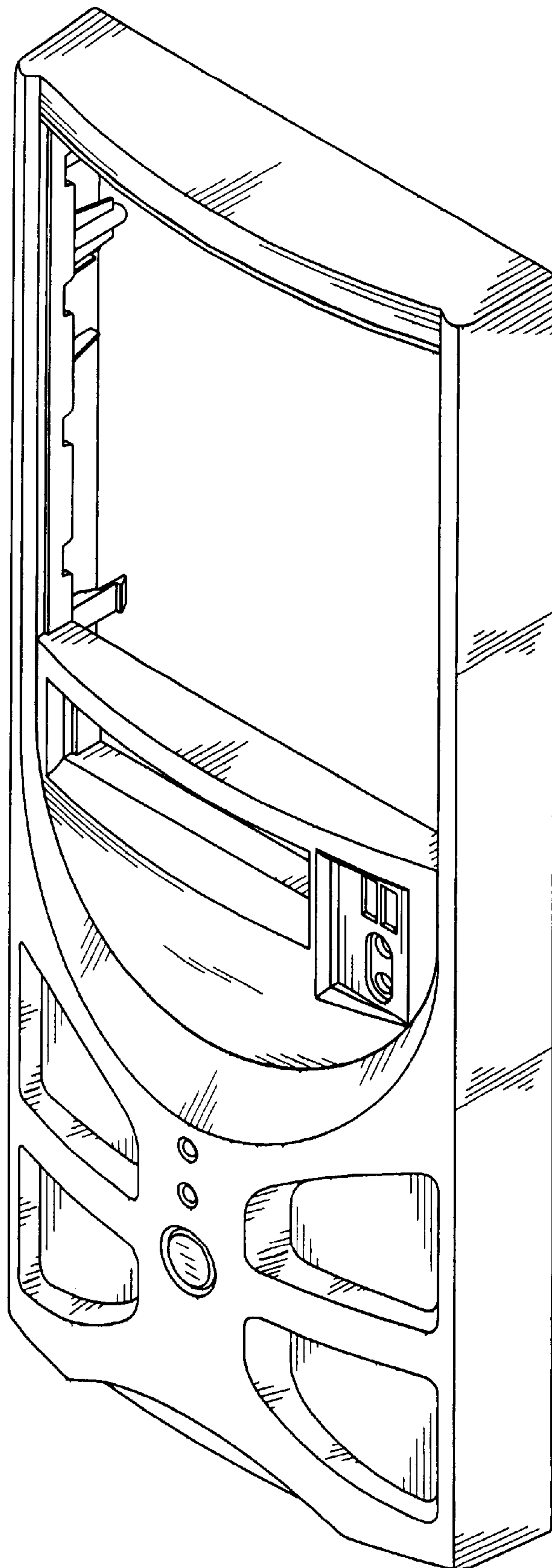

FIG. 1

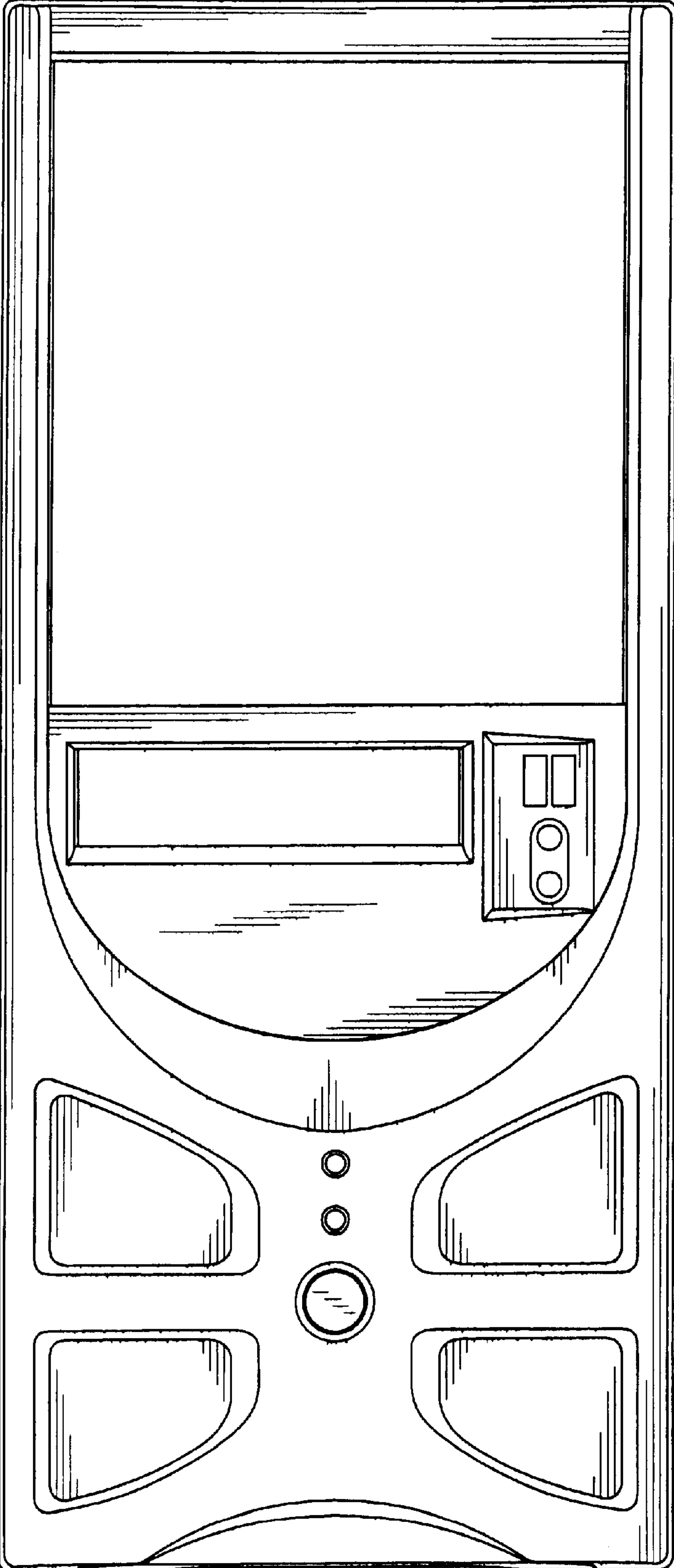

FIG. 2

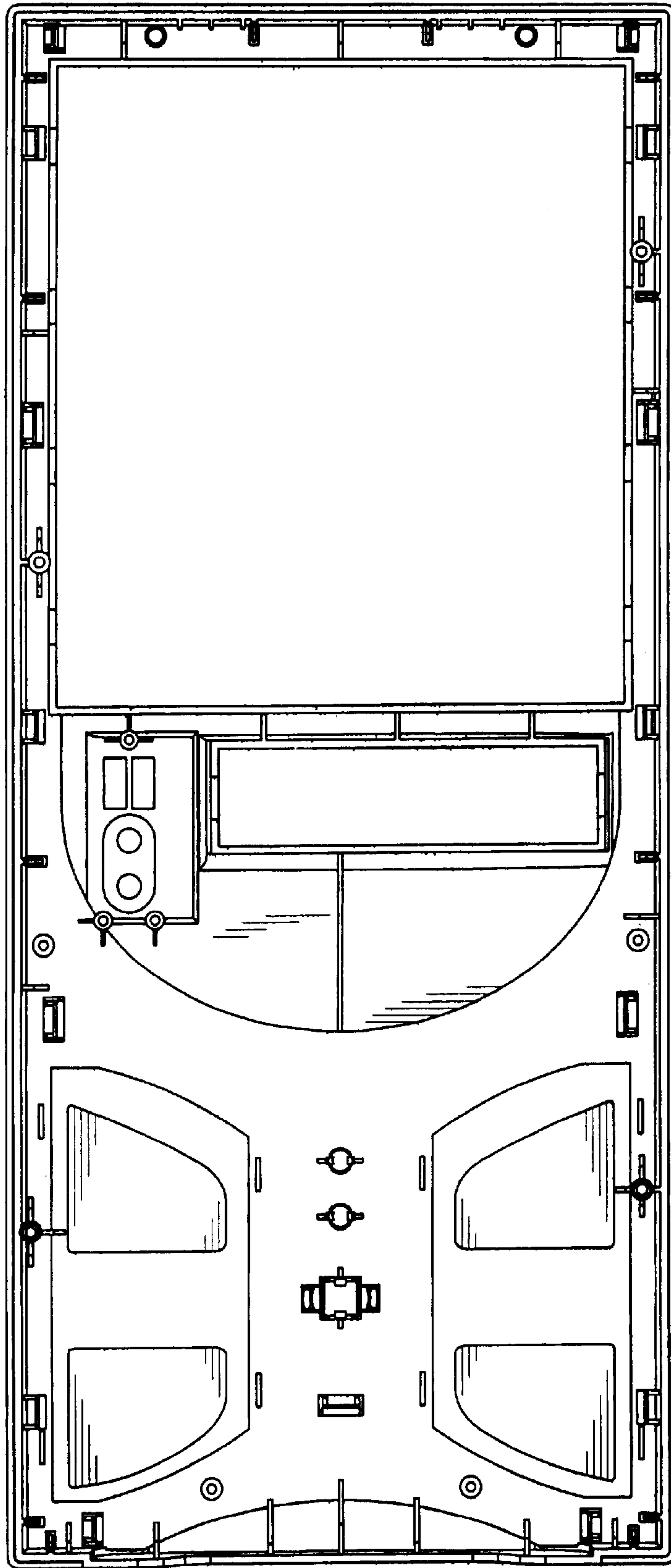

FIG. 3

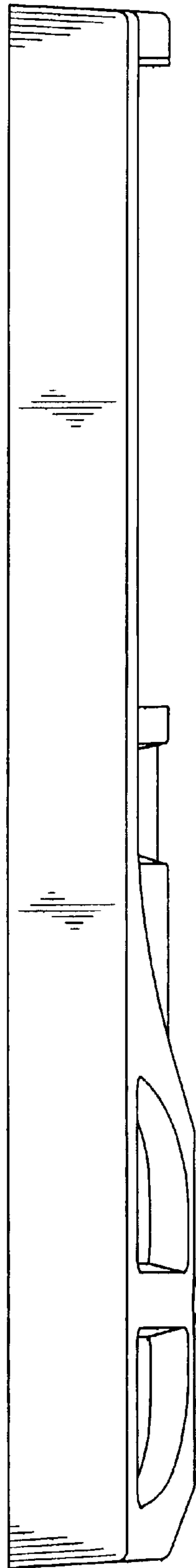

FIG. 4

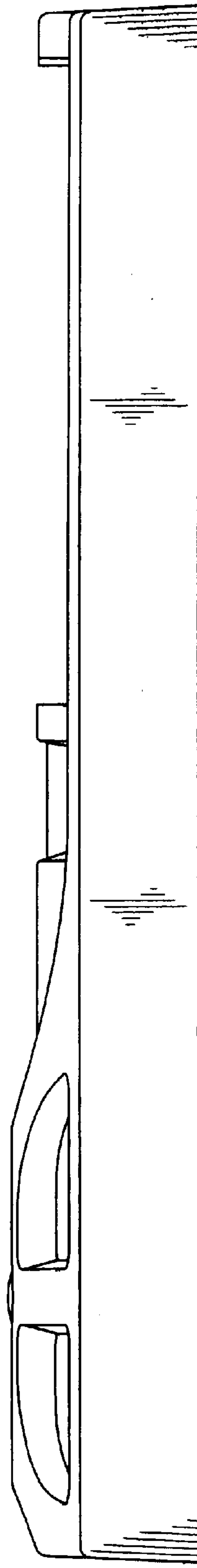

FIG. 5

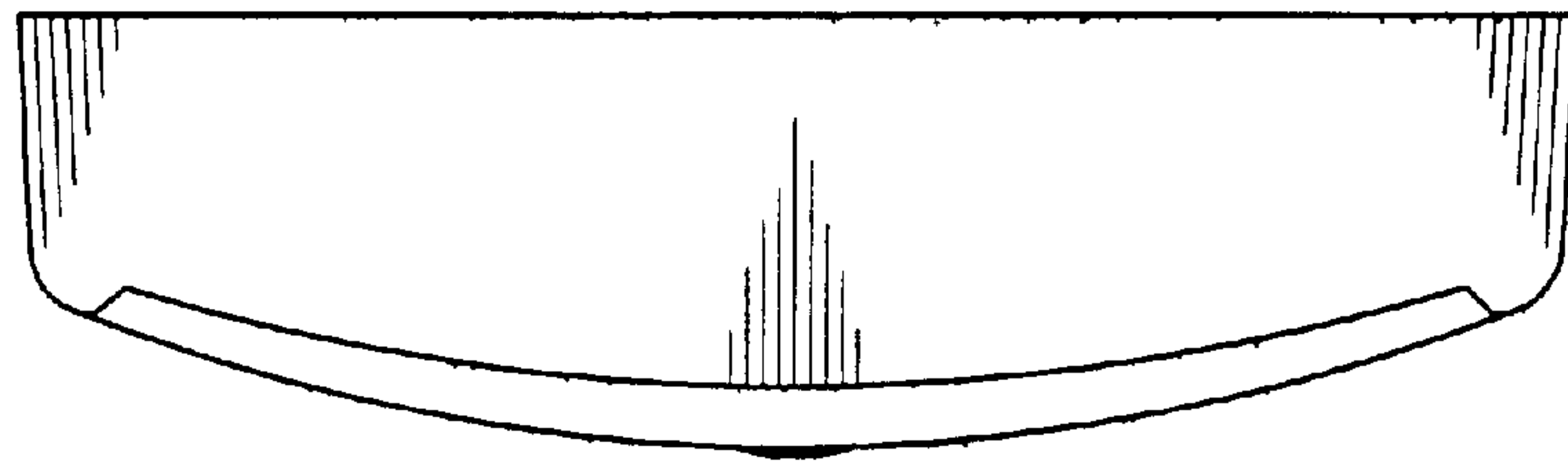

FIG. 6

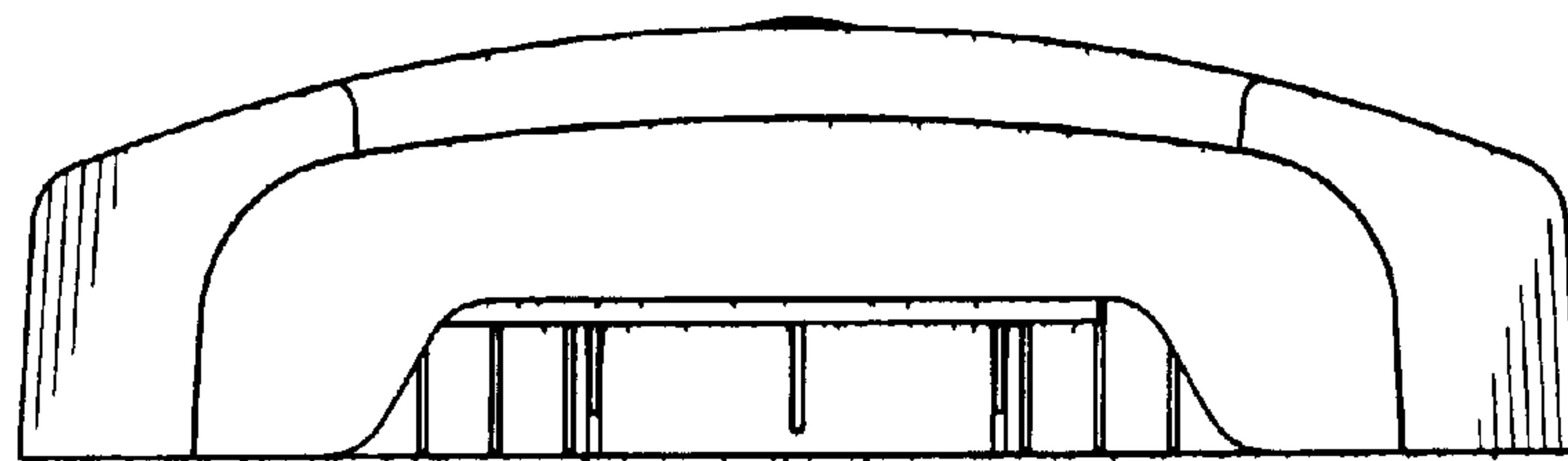

FIG. 7



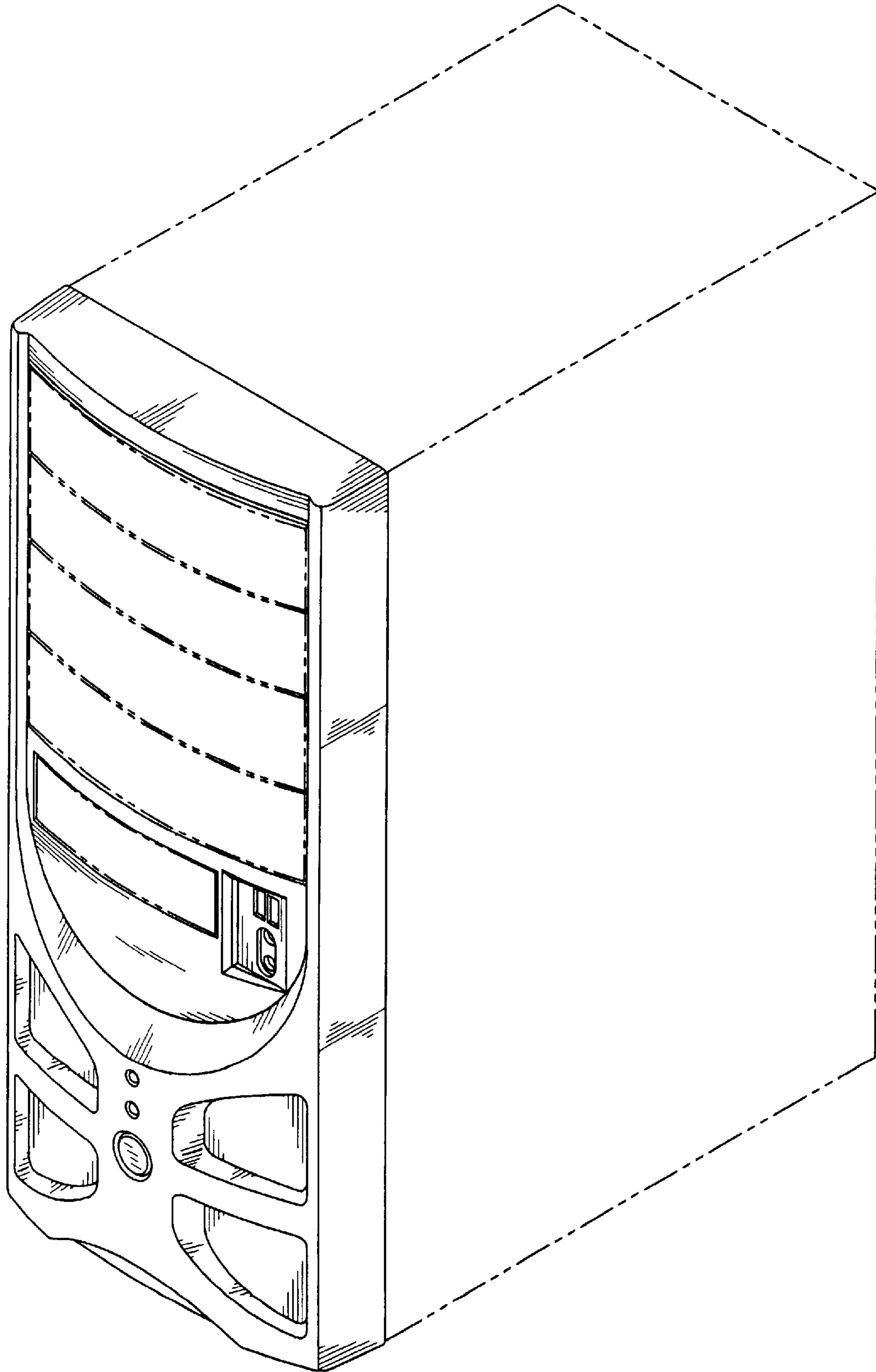

FIG. 8