



US00D512535S

(12) **United States Design Patent** (10) **Patent No.:** **US D512,535 S**
Willows et al. (45) **Date of Patent:** **** Dec. 6, 2005**

(54) **SLING**

DESCRIPTION

(76) Inventors: **Keith S. Willows**, 1823 12th Ave. West, Seattle, WA (US) 98119; **Antonio C. Del Rosario**, 3265 112th Ave. SE., Bellevue, WA (US) 98004; **June Angus**, 1823 12th Ave. West, Seattle, WA (US) 98119

(**) Term: **14 Years**

(21) Appl. No.: **29/194,552**

(22) Filed: **Nov. 26, 2003**

(51) **LOC (8) Cl.** **02-02**

(52) **U.S. Cl.** **D29/122; D29/101.2; D29/101.3**

(58) **Field of Search** D29/101.1-101.5, D29/100, 122; D2/626, 628, 629, 829; D3/215, 218, 219, 221, 226; D24/190; 359/519; 362/108; 182/3; 2/300, 310; 224/576, 606, 646, 259, 640, 603, 623, 627, 647; D10/111

(56) **References Cited**

U.S. PATENT DOCUMENTS

630,157	A	*	8/1899	Worth	2/102
1,310,958	A	*	7/1919	O'Connor	297/484
3,089,143	A	*	5/1963	Jacobson	2/1
4,479,267	A	*	10/1984	Radowsky, Jr.	2/337
4,534,619	A	*	8/1985	Bedford	359/519
4,764,962	A	*	8/1988	Ekman et al.	381/301
D342,348	S	*	12/1993	Panarelli	D29/101.1
D346,482	S	*	5/1994	Merrill	D2/627
5,477,998	A	*	12/1995	Reckler	224/586
5,624,065	A	*	4/1997	Steffe	224/625
D387,499	S	*	12/1997	Schmidt	D29/101.1
D422,931	S	*	4/2000	Agnew	D10/111
D435,168	S	*	12/2000	Momburg	D3/215
6,345,751	B1	*	2/2002	Elliot	224/646
6,527,082	B1	*	3/2003	Taylor	182/3
6,626,131	B2	*	9/2003	Moulton, III	119/770

* cited by examiner

Primary Examiner—Lucy Lieberman

(57) **CLAIM**

The ornamental design for a “sling,” as shown and described.

FIG. 1 is a front perspective view of a sling;
 FIG. 2 is a front view of a sling;
 FIG. 3 is a back view of a sling;
 FIG. 4 is a top view of a sling;
 FIG. 5 is a bottom view of a sling;
 FIG. 6 is a right side view of a sling; the left side view being a mirror image thereof;
 FIG. 7 is a front perspective view of a second embodiment of a sling;
 FIG. 8 is a front view of a second embodiment of a sling;
 FIG. 9 is a back view of a second embodiment of a sling;
 FIG. 10 is a top view of a second embodiment of a sling;
 FIG. 11 is a bottom view of a second embodiment of a sling;
 FIG. 12 is a right side view of a second embodiment of a sling, the left side view being a mirror image thereof;
 FIG. 13 is a front perspective view of a third embodiment of a sling;
 FIG. 14 is a front view of a third embodiment of a sling;
 FIG. 15 is a back view of a third embodiment of a sling;
 FIG. 16 is a top view of a third embodiment of a sling;
 FIG. 17 is a right side view of a third embodiment of a sling;
 FIG. 18 is a right side view of a third embodiment of a sling, the left side view being a mirror image thereof;
 FIG. 19 is a front perspective view of a fourth embodiment of a sling;
 FIG. 20 is a front view of a fourth embodiment of a sling;
 FIG. 21 is a back view of a fourth embodiment of a sling;
 FIG. 22 is a top view of a fourth embodiment of a sling;
 FIG. 23 is a bottom view of a fourth embodiment of a sling;
 FIG. 24 is a right side view of a fourth embodiment of a sling, the left side view being a mirror image thereof;
 FIG. 25 is a front perspective view of a fifth embodiment of a sling;
 FIG. 26 is a front view of a fifth embodiment of a sling; the back view being FIG. 3; the side view being FIG. 41, the left side view being a mirror image thereof;
 FIG. 27 is a top view of a fifth embodiment of a sling;

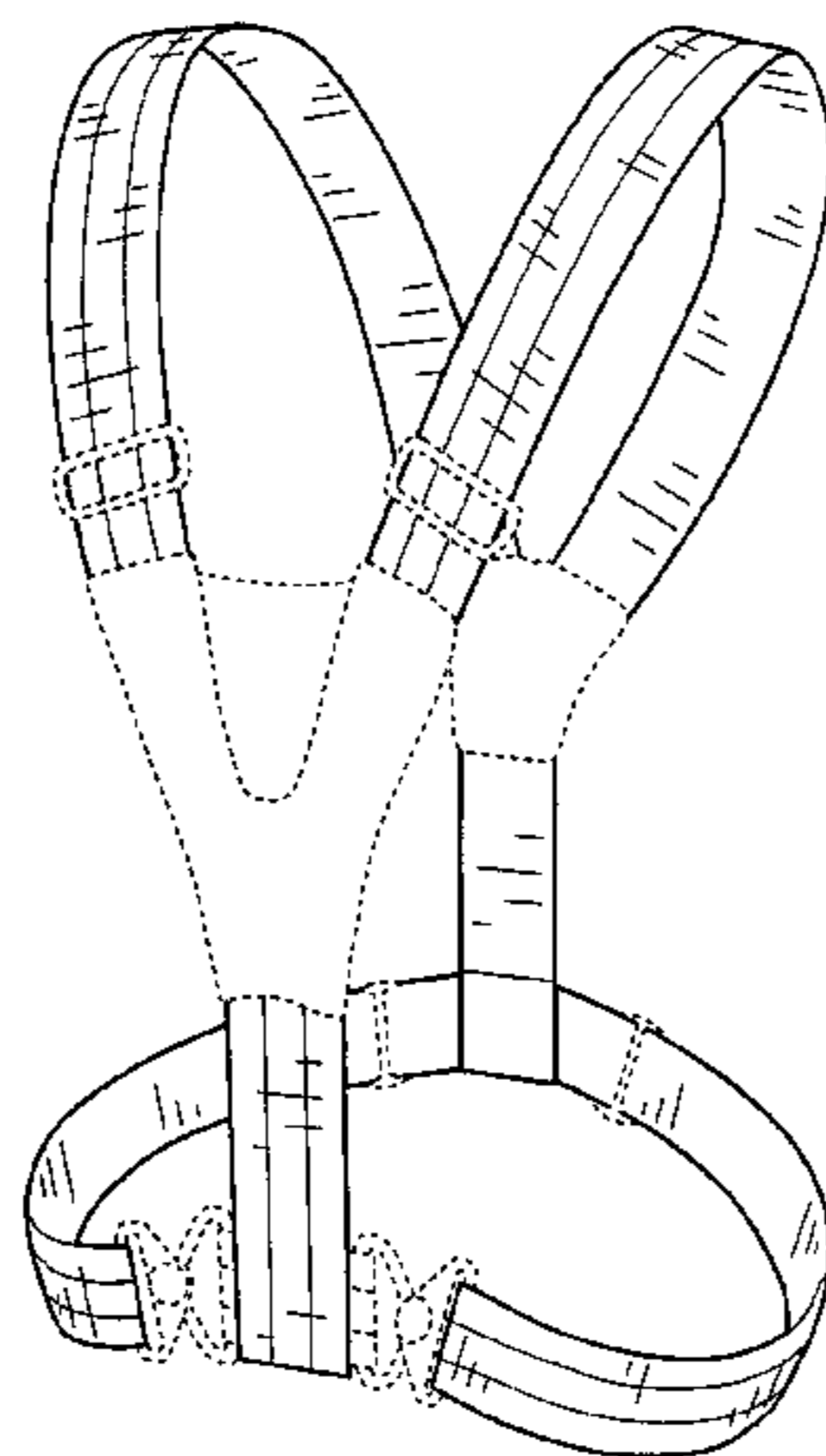

FIG. 28 is a bottom view of a fifth embodiment of a sling;
FIG. 29 is a front perspective view of a sixth embodiment of a sling;

FIG. 30 is a front view of a sixth embodiment of a sling; the back view being FIG. 9; the side view being FIG. 42, the left side view being a mirror image thereof;

FIG. 31 is a top view of a sixth embodiment of a sling;

FIG. 32 is a bottom view of a sixth embodiment of a sling;

FIG. 33 is a front perspective view of a seventh embodiment of a sling;

FIG. 34 is a front view of a seventh embodiment of a sling; the back view being FIG. 15; the side view being FIG. 43, the left side view being a mirror image thereof;

FIG. 35 is a top view of a seventh embodiment of a sling;

FIG. 36 is a bottom view of a seventh embodiment of a sling;

FIG. 37 is a front perspective view of an eighth embodiment of a sling;

FIG. 38 is a front view of an eighth embodiment of a sling; the back view being FIG. 21; the side view being FIG. 44, the left side view being a mirror image thereof;

FIG. 39 is a top view of an eighth embodiment of a sling;

FIG. 40 is a bottom view of an eighth embodiment of a sling.

FIG. 41 is a side view of the fifth embodiment;

FIG. 42 is a side view of the sixth embodiment;

FIG. 43 is a side view of the seventh embodiment; and,

FIG. 44 is a side view of the eighth embodiment.

The broken lines in the drawings are for illustrative purposes only and form no part of the claimed design.

1 Claim, 22 Drawing Sheets

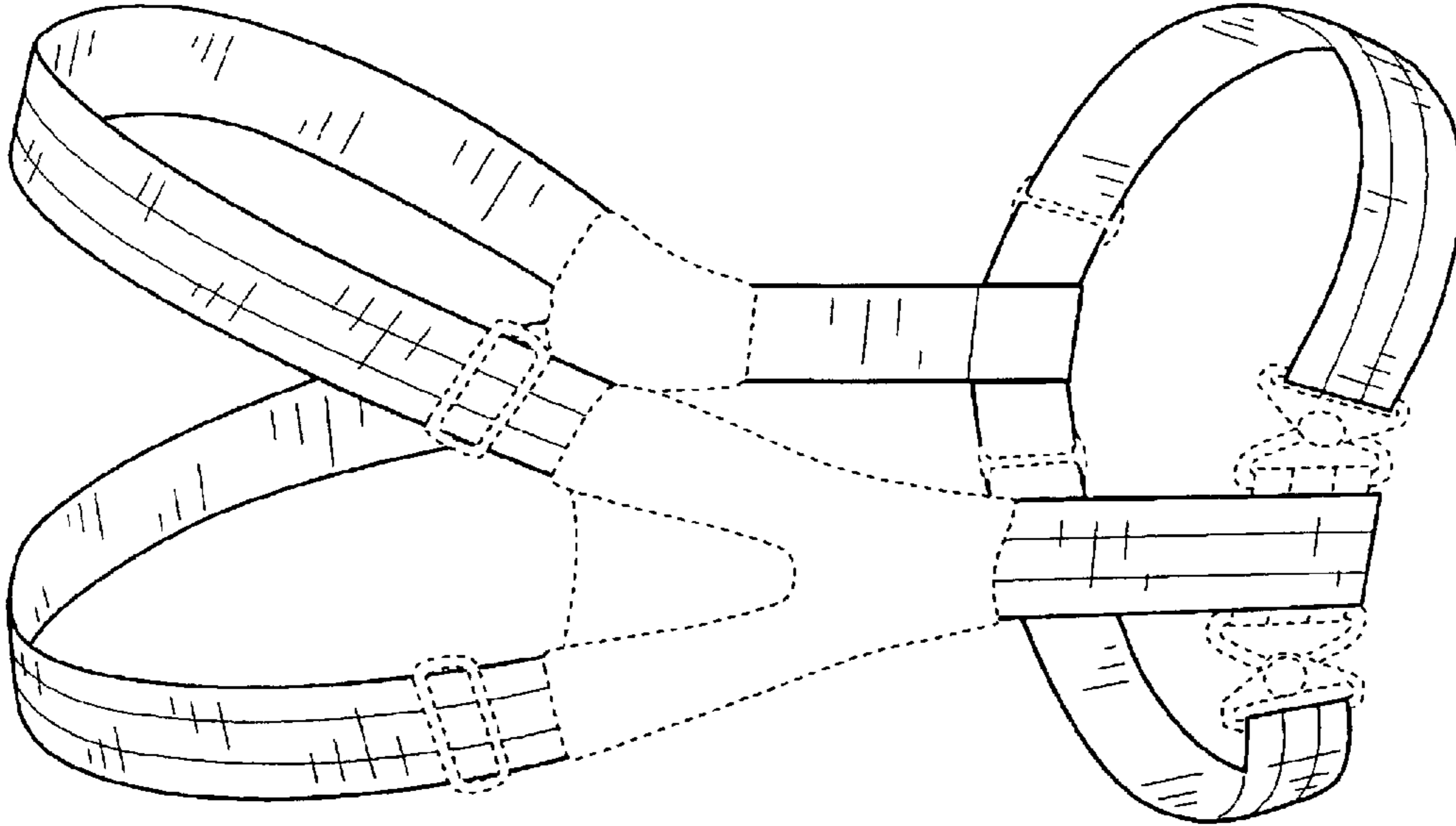

FIG. 1

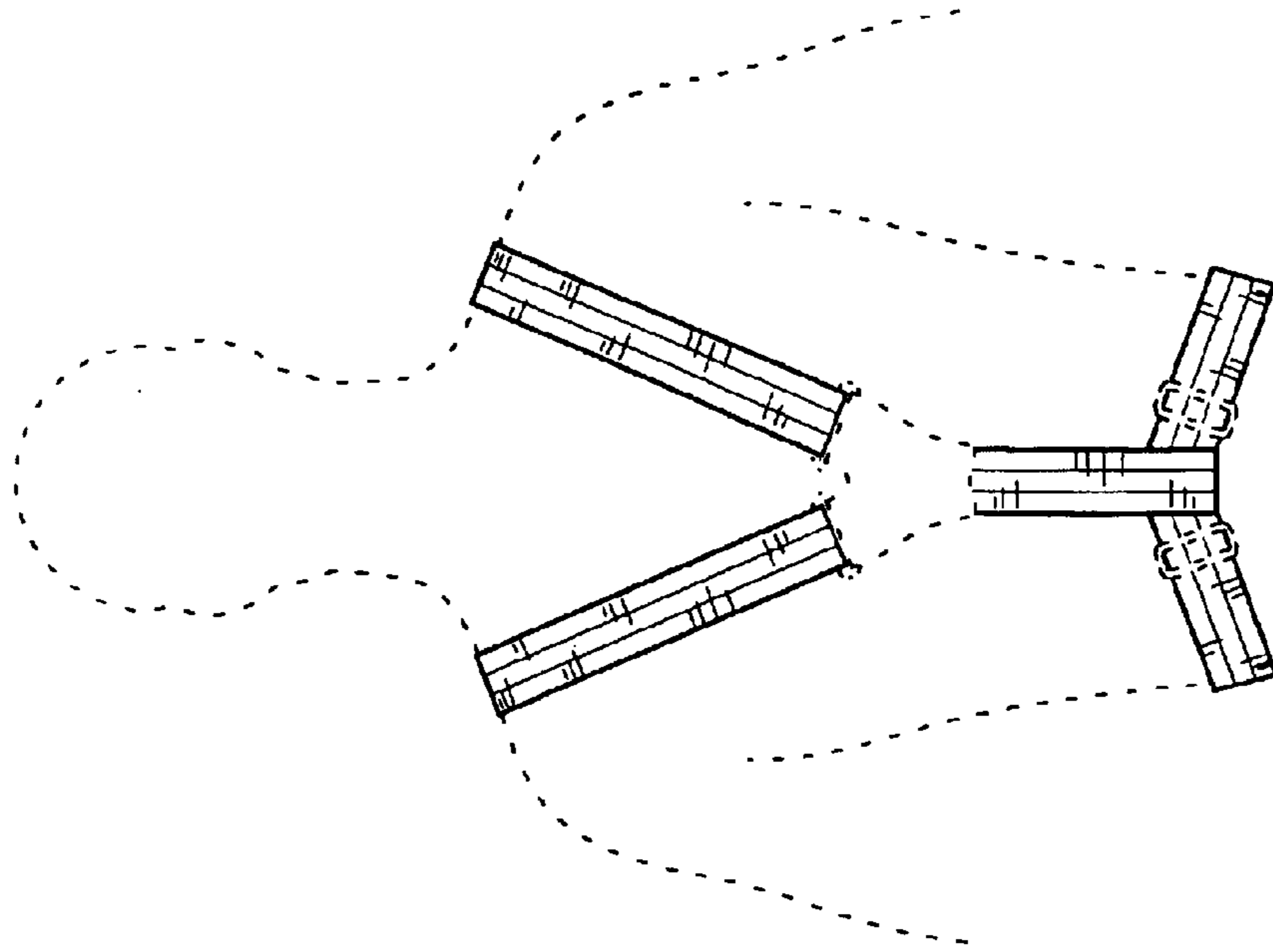

FIG. 3

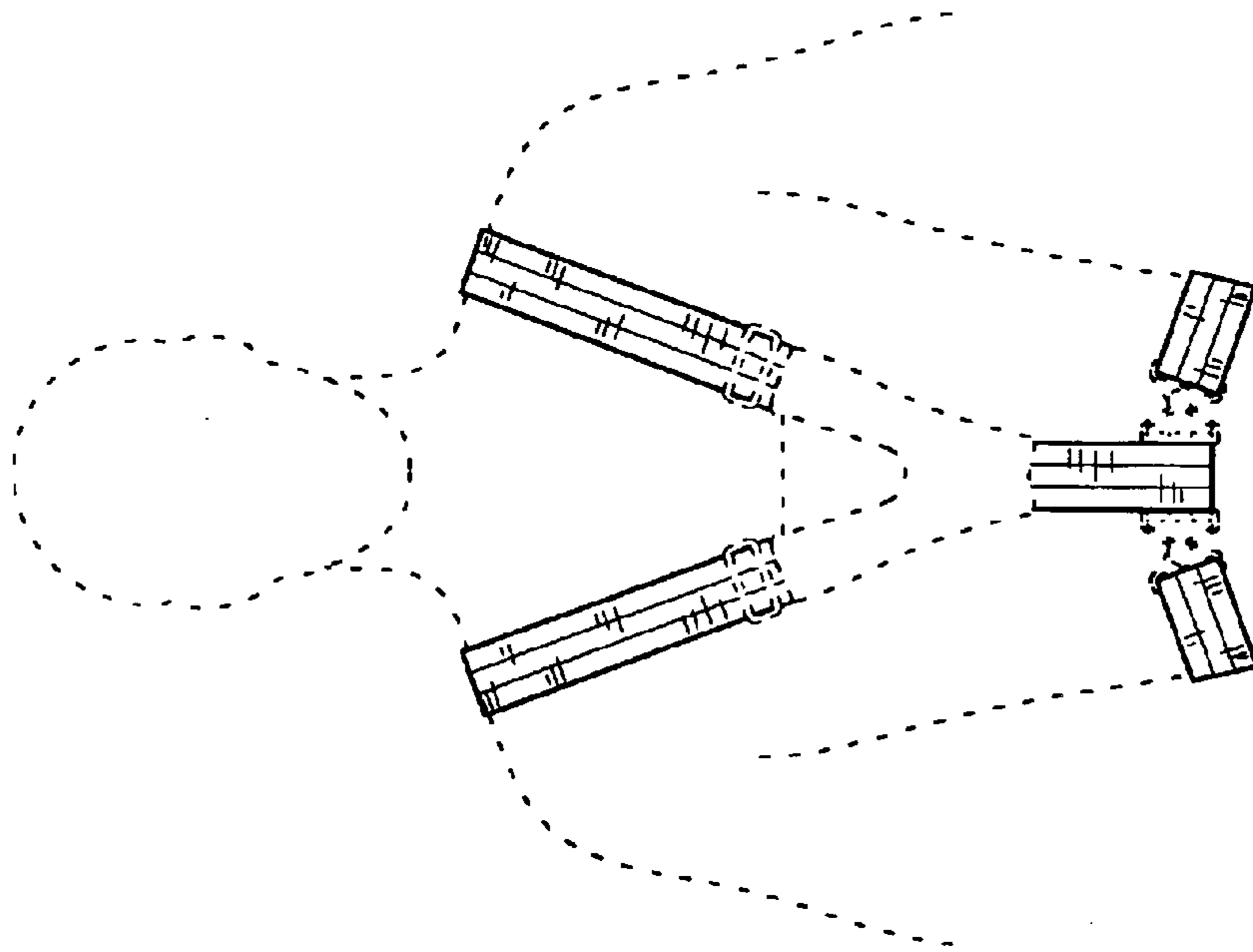

FIG. 2

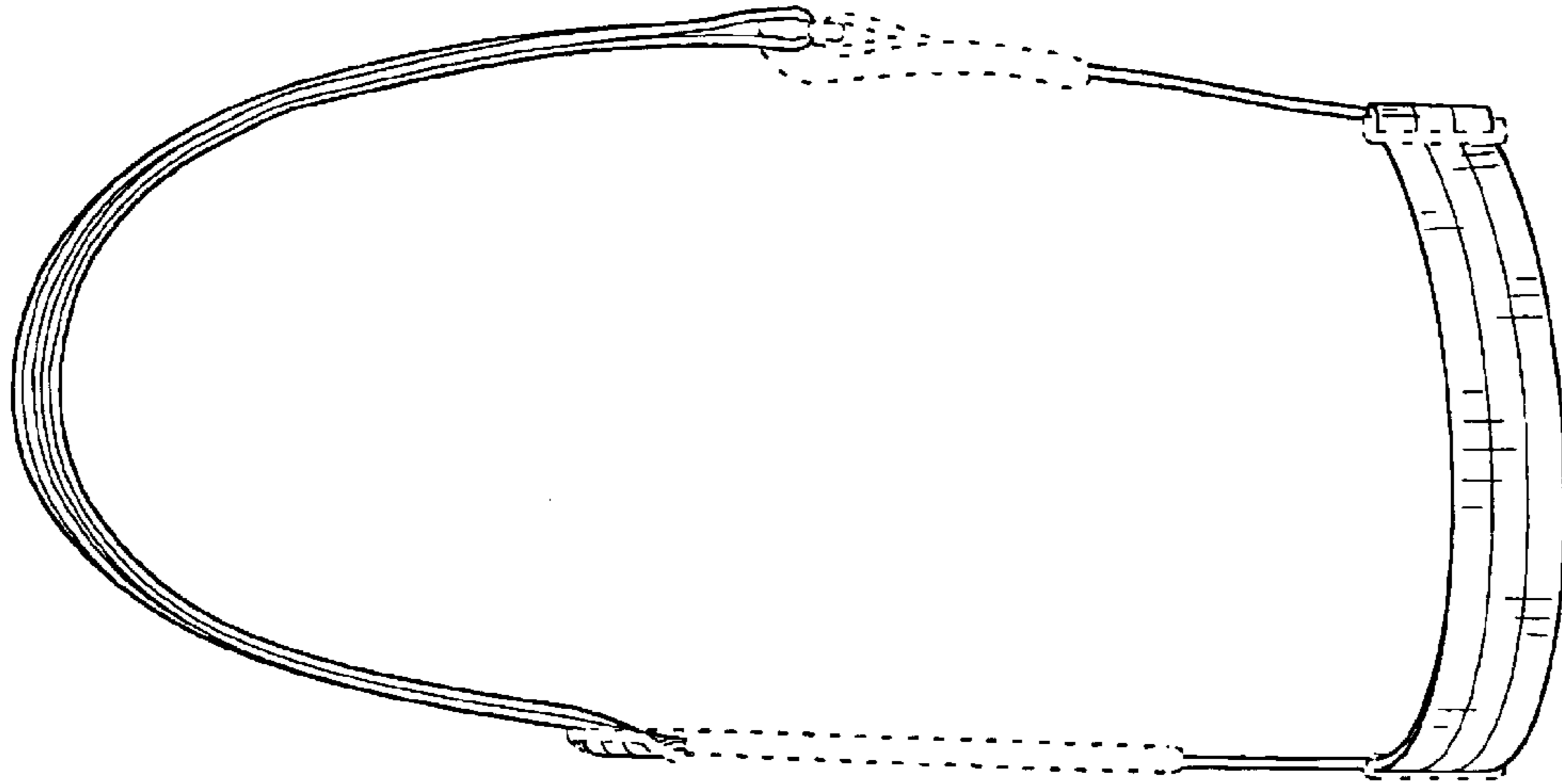

FIG. 6

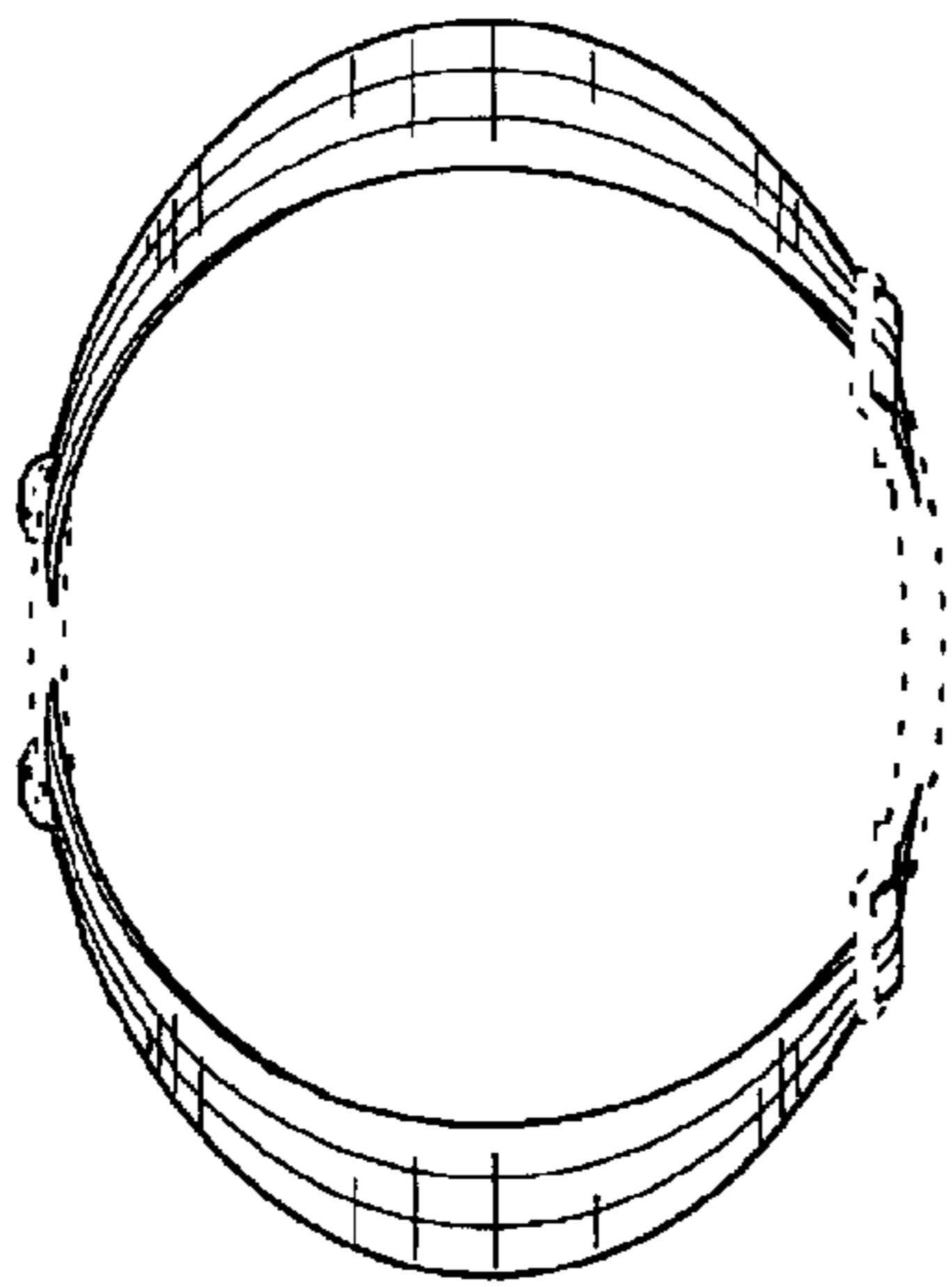

FIG. 4

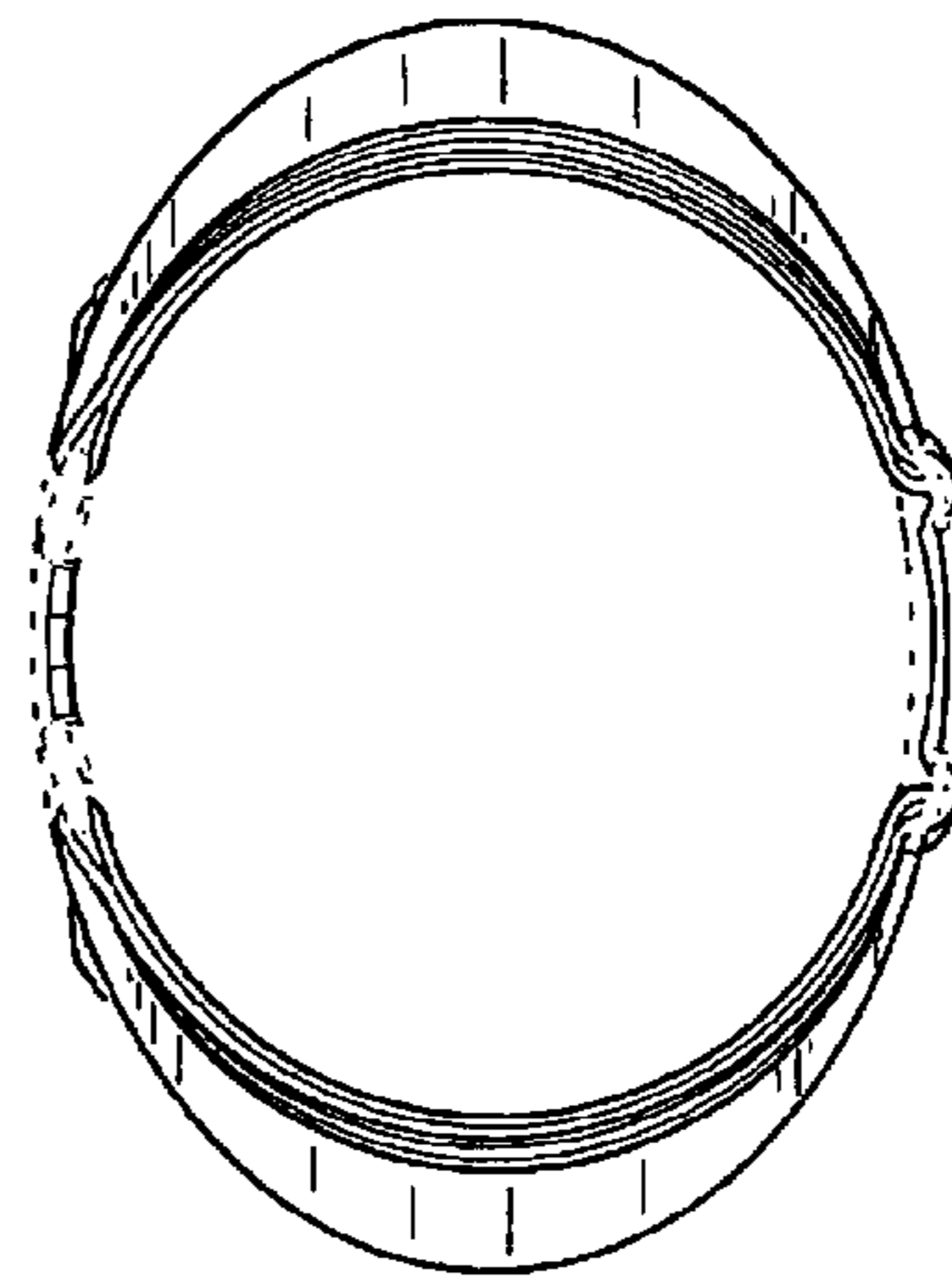

FIG. 5

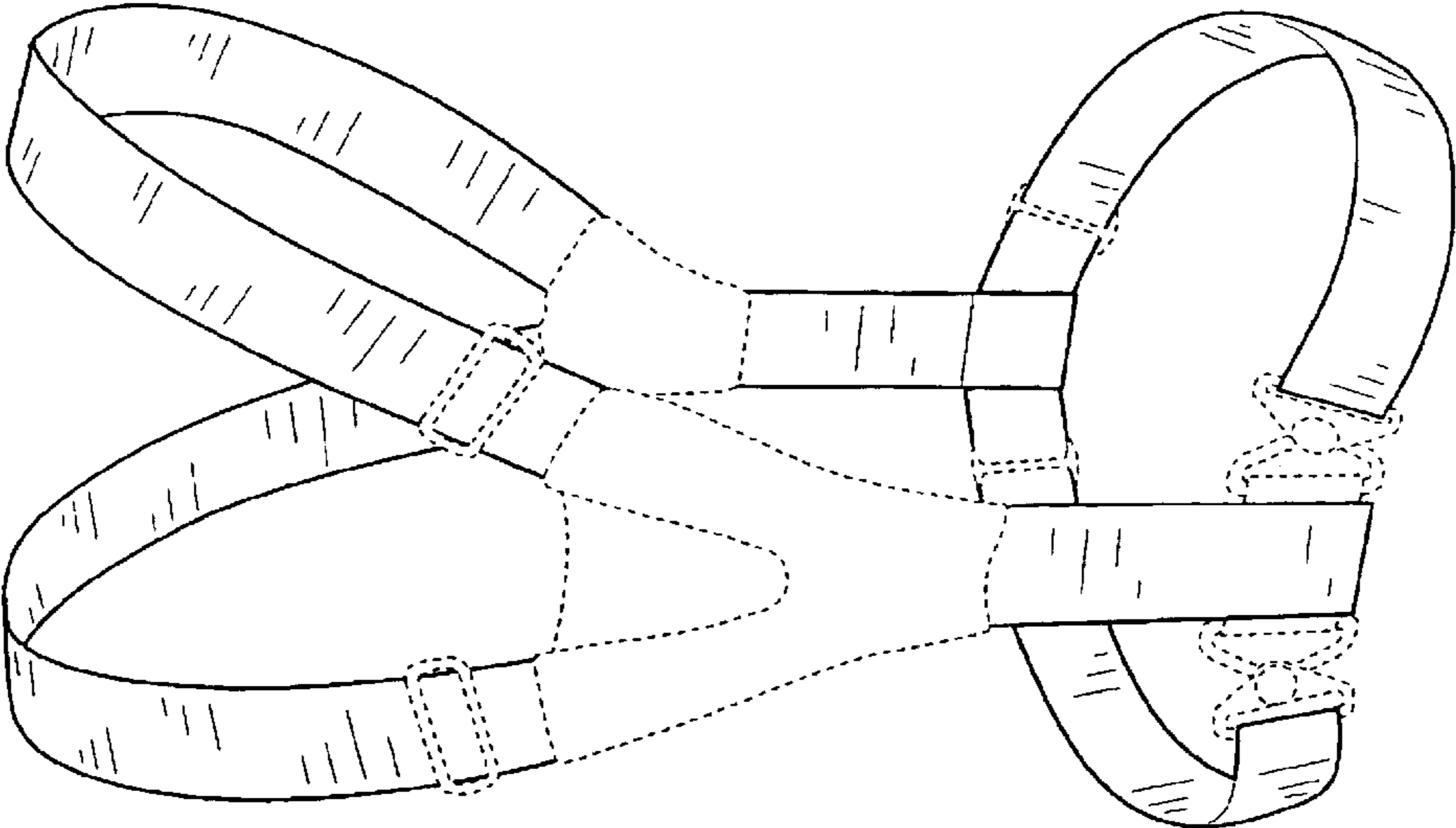

FIG. 7

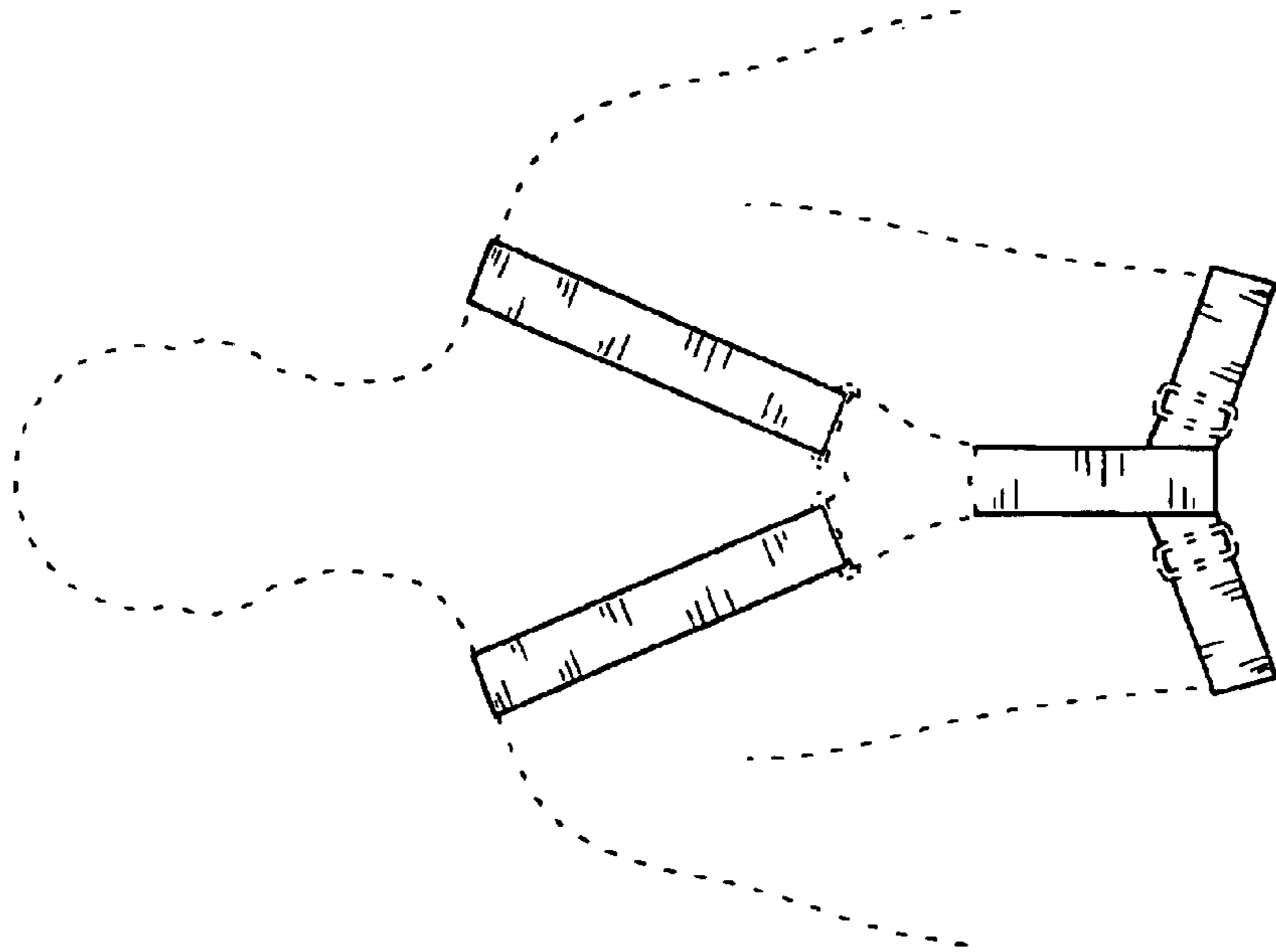

FIG. 9

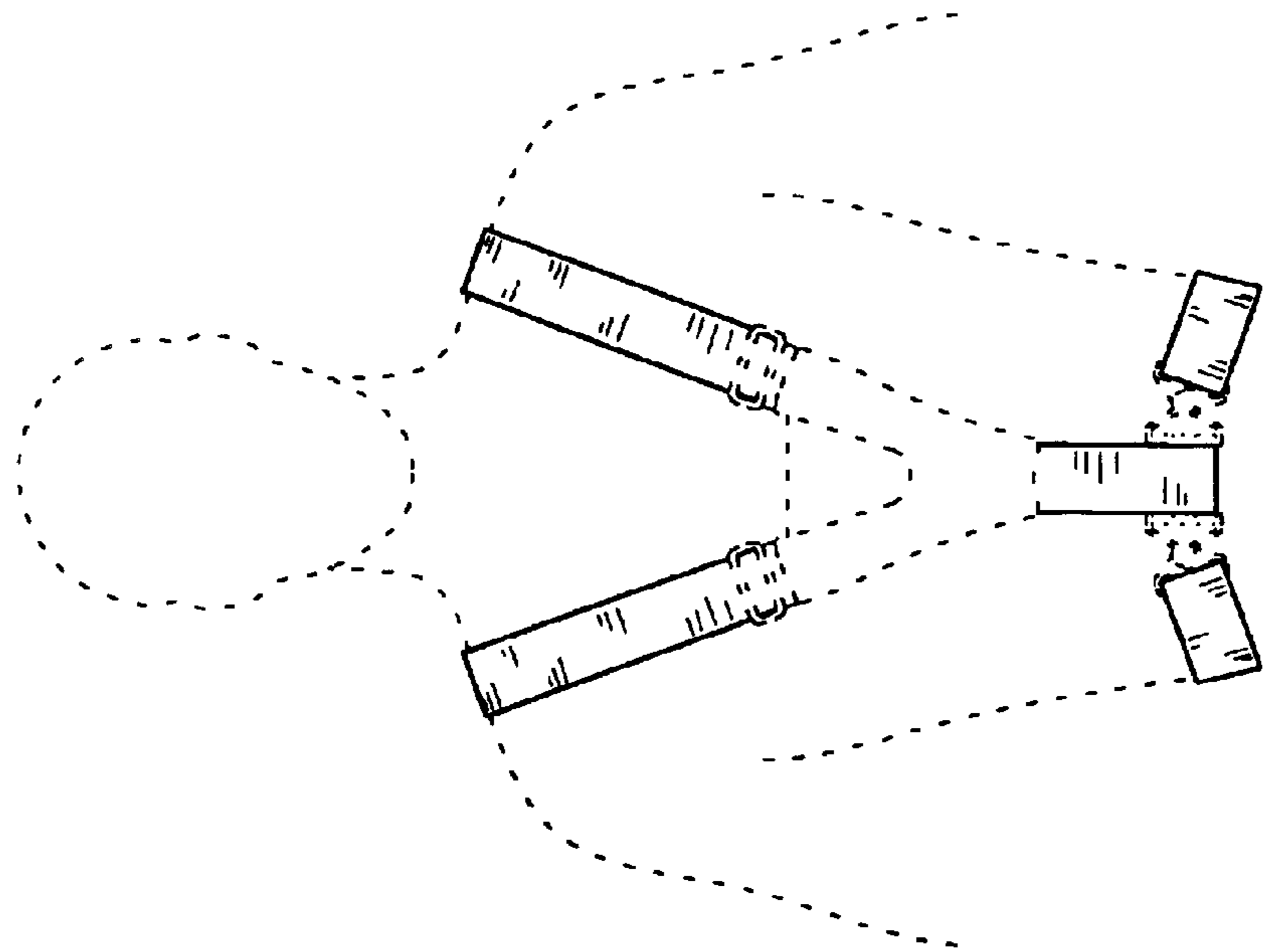

FIG. 8

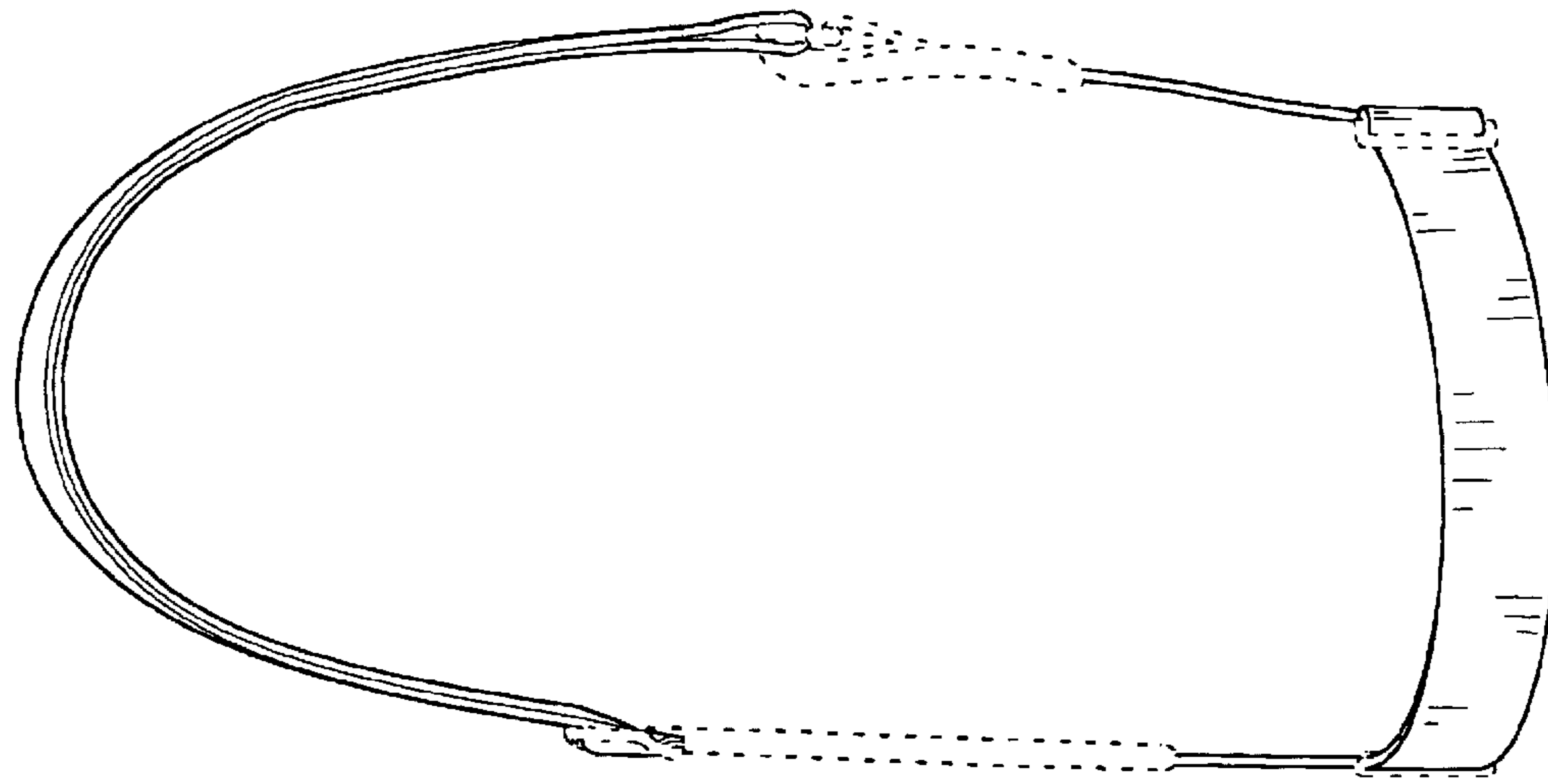

FIG. 12

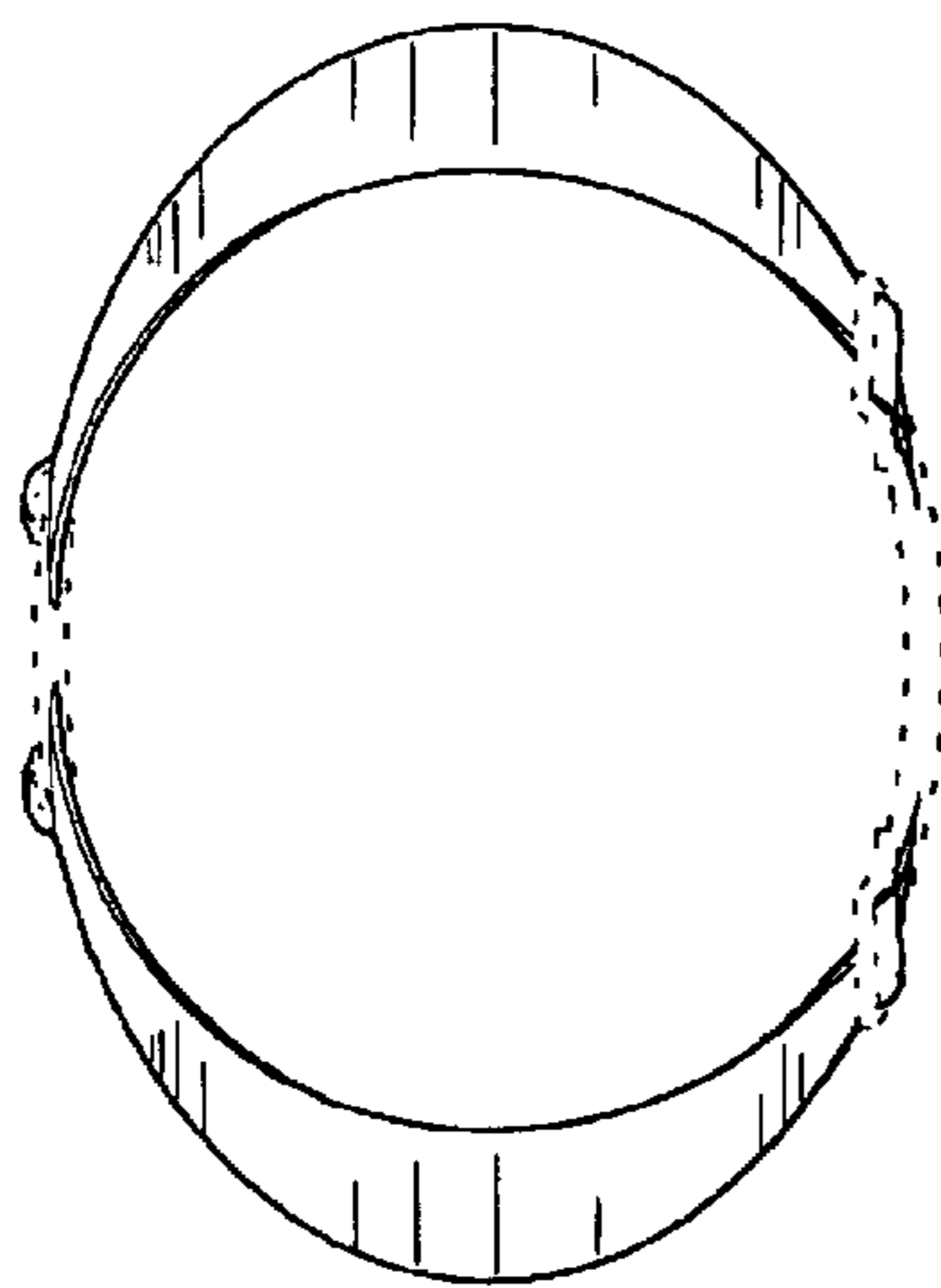

FIG. 10

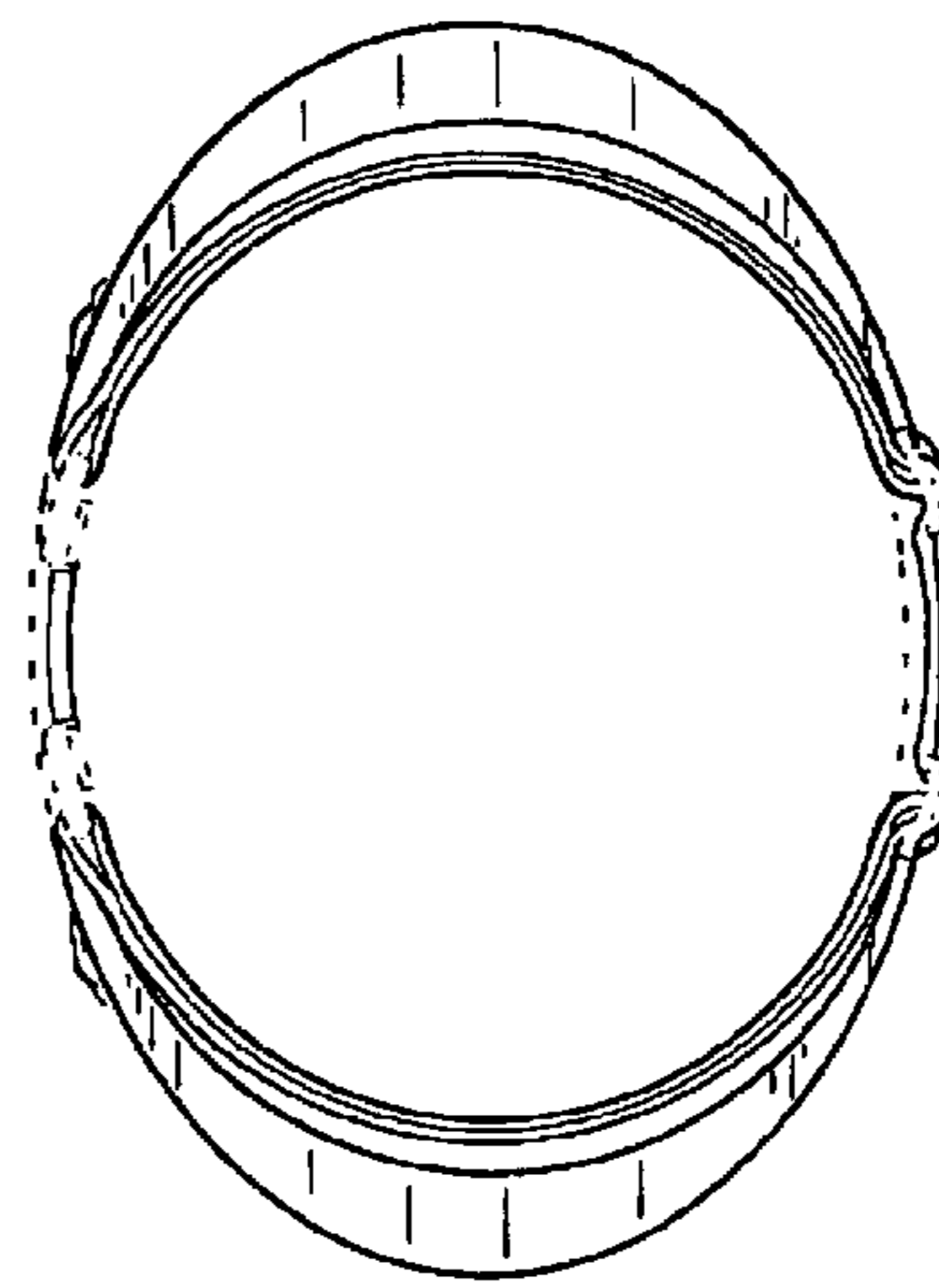

FIG. 11

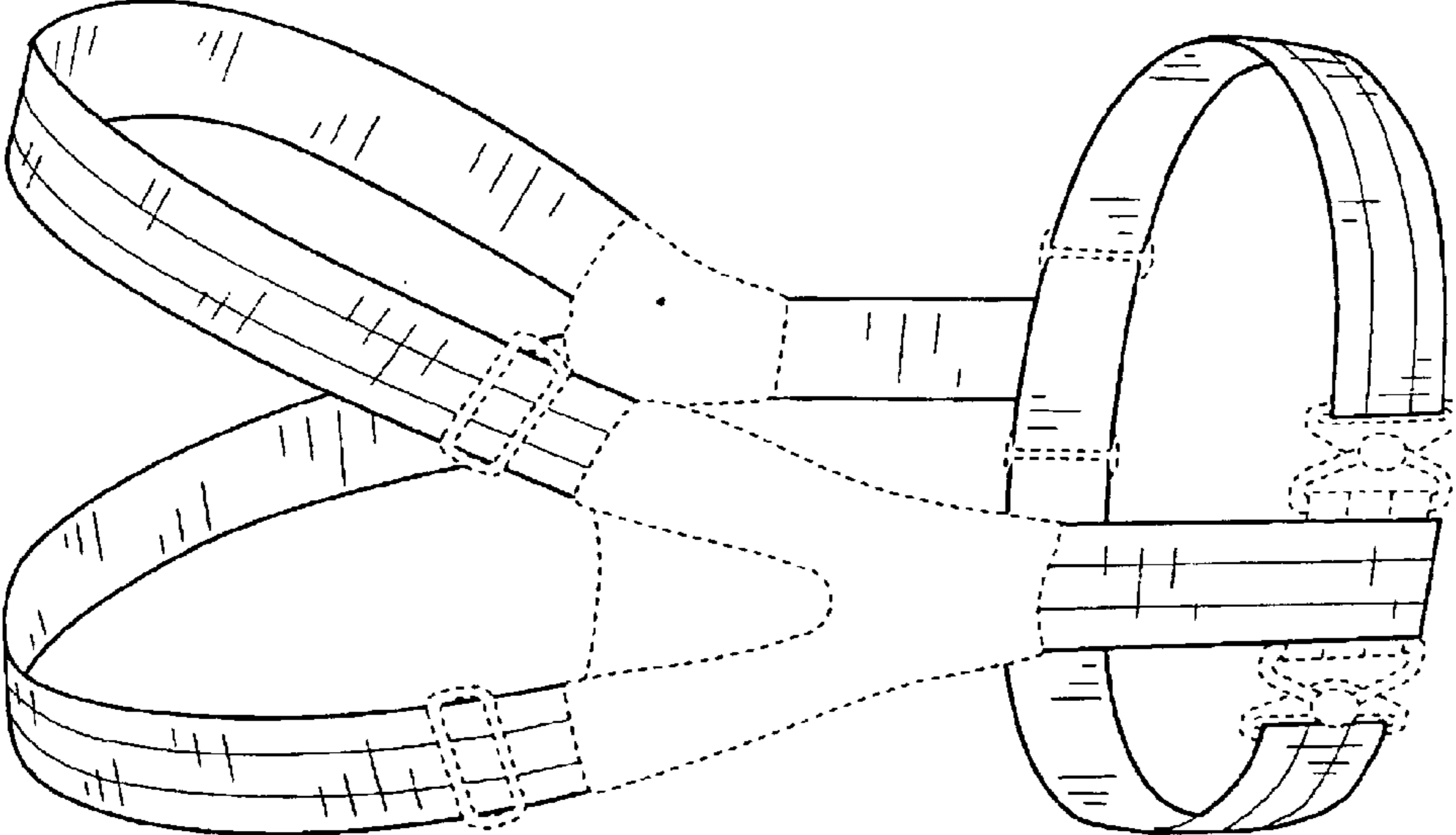

FIG. 13

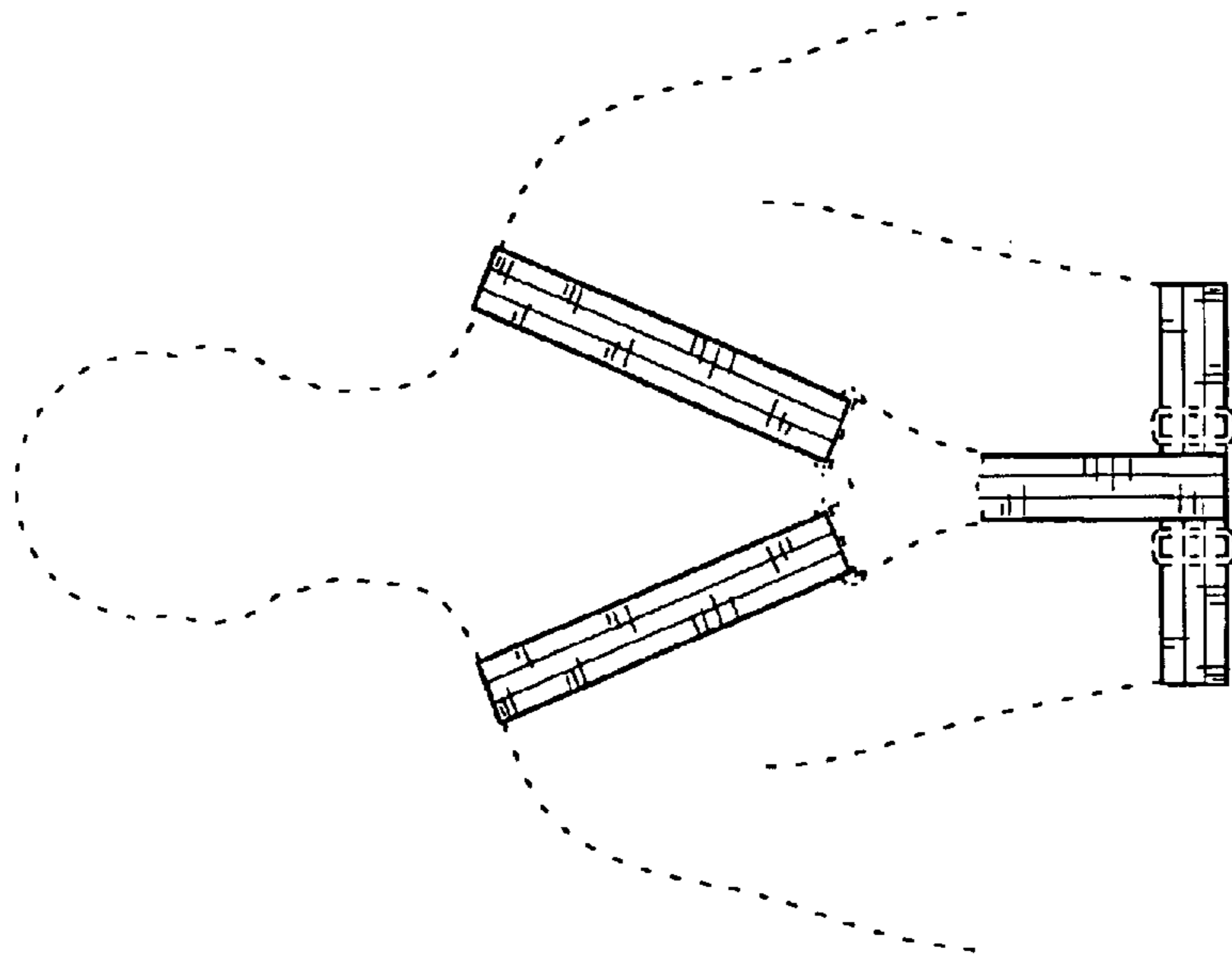

FIG. 15

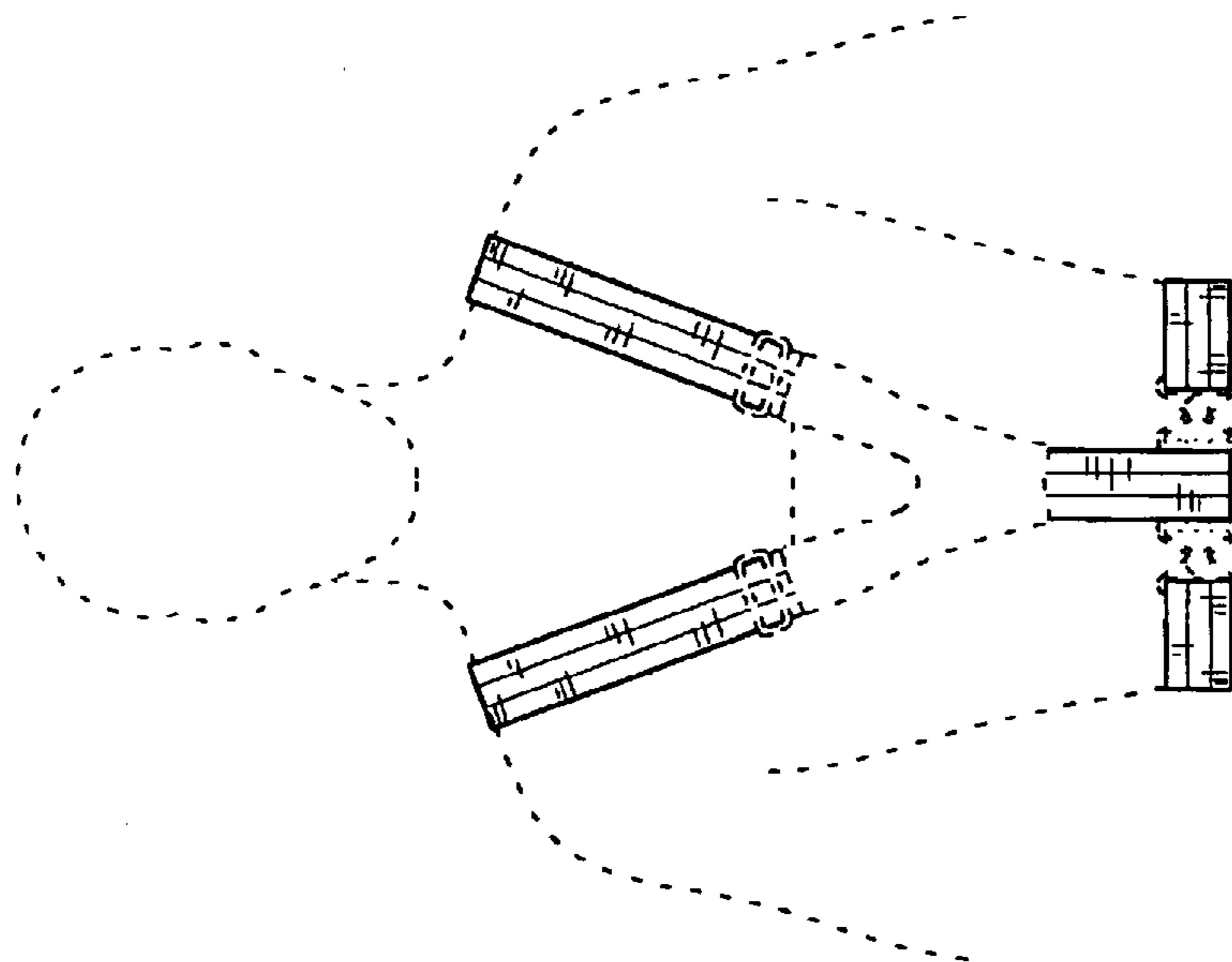

FIG. 14

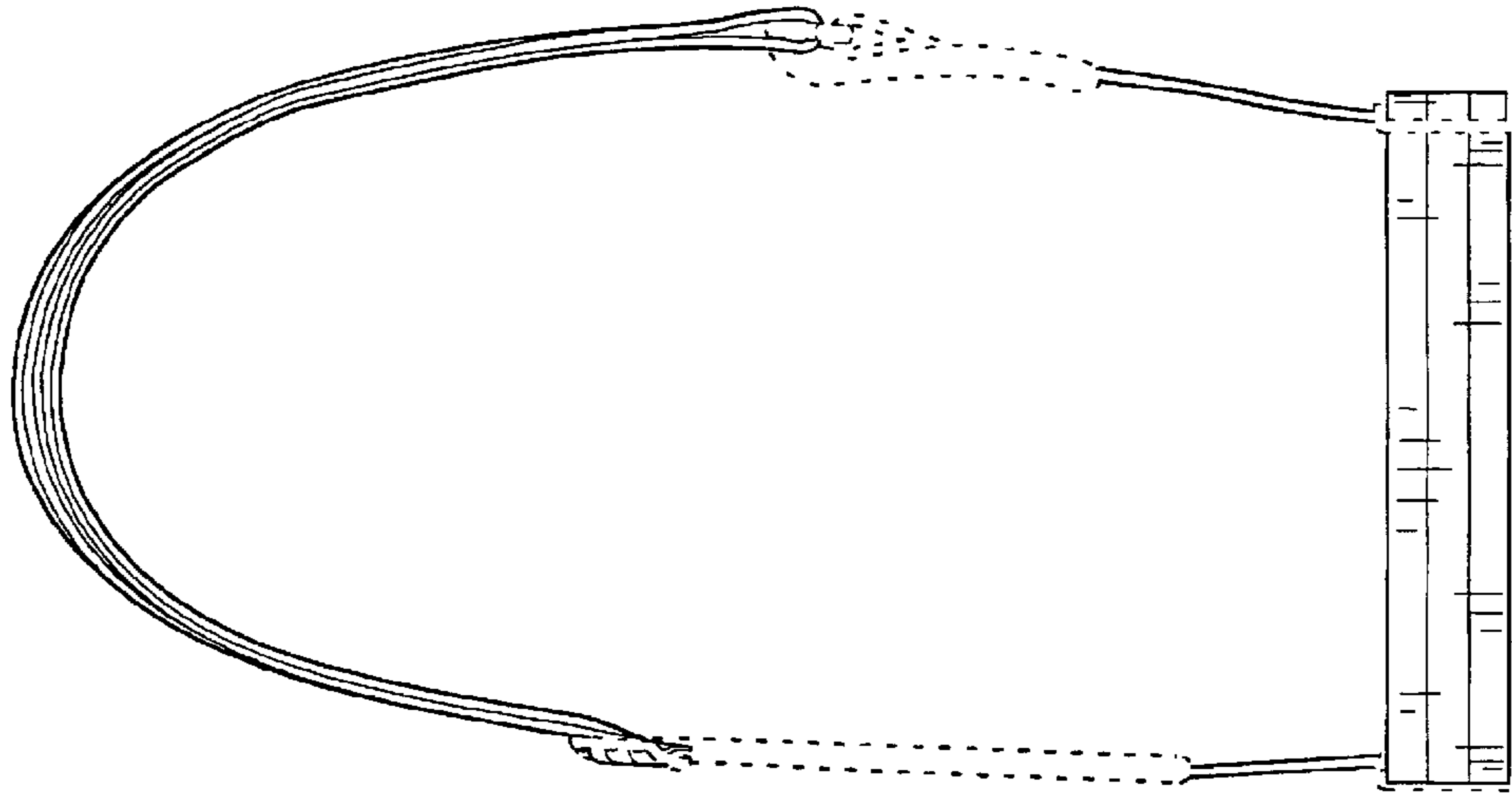

FIG. 18

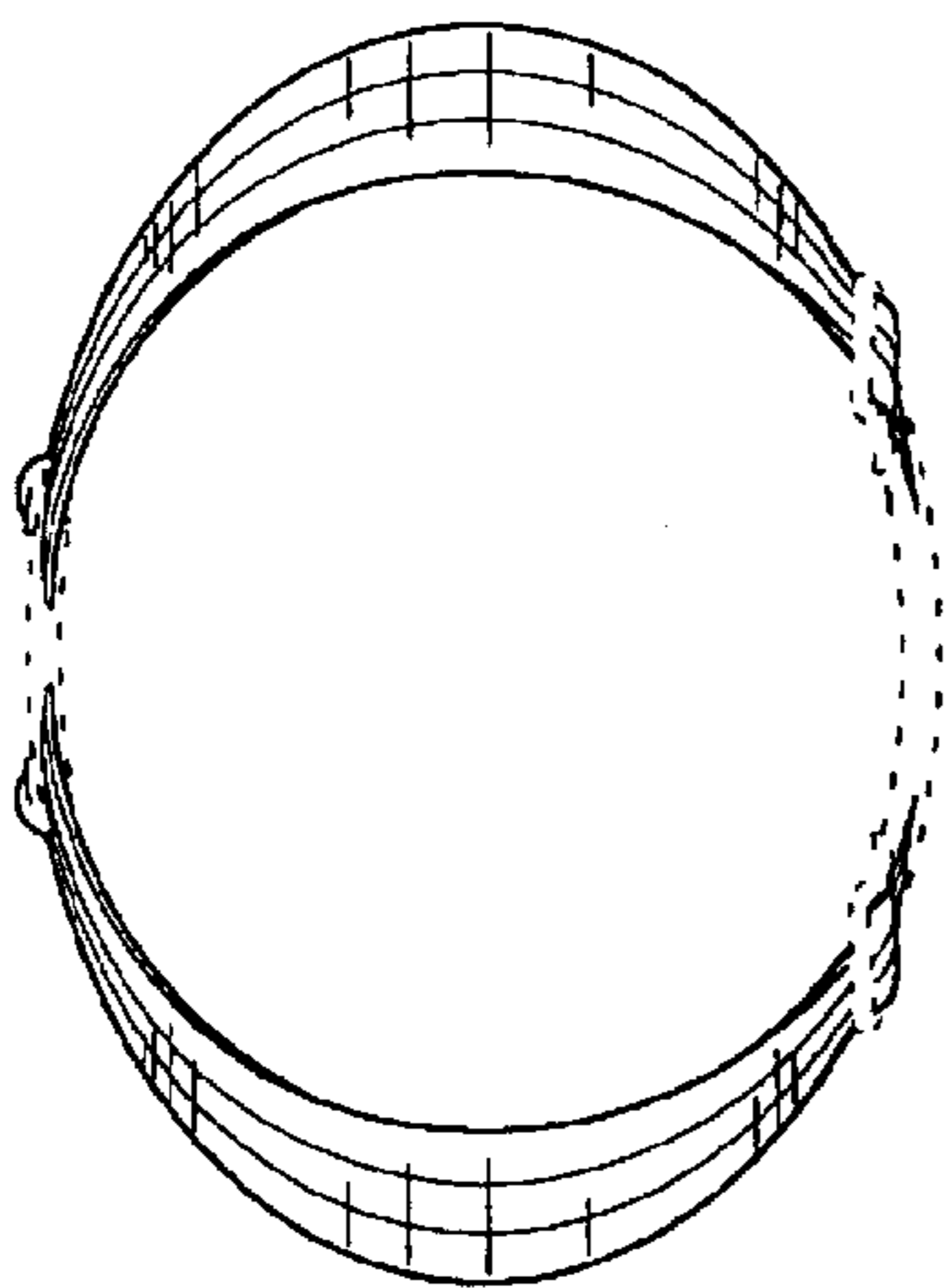

FIG. 16

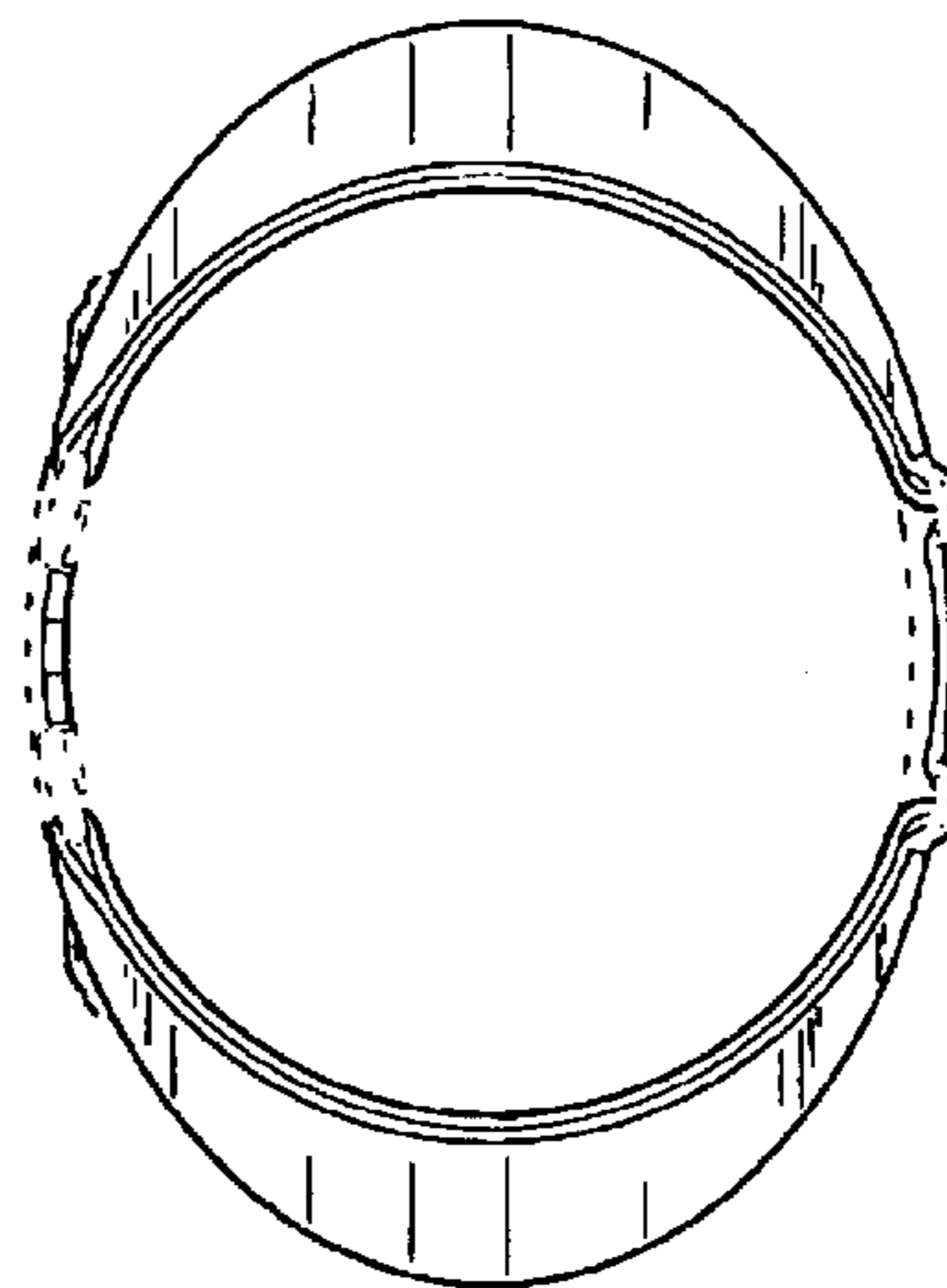

FIG. 17

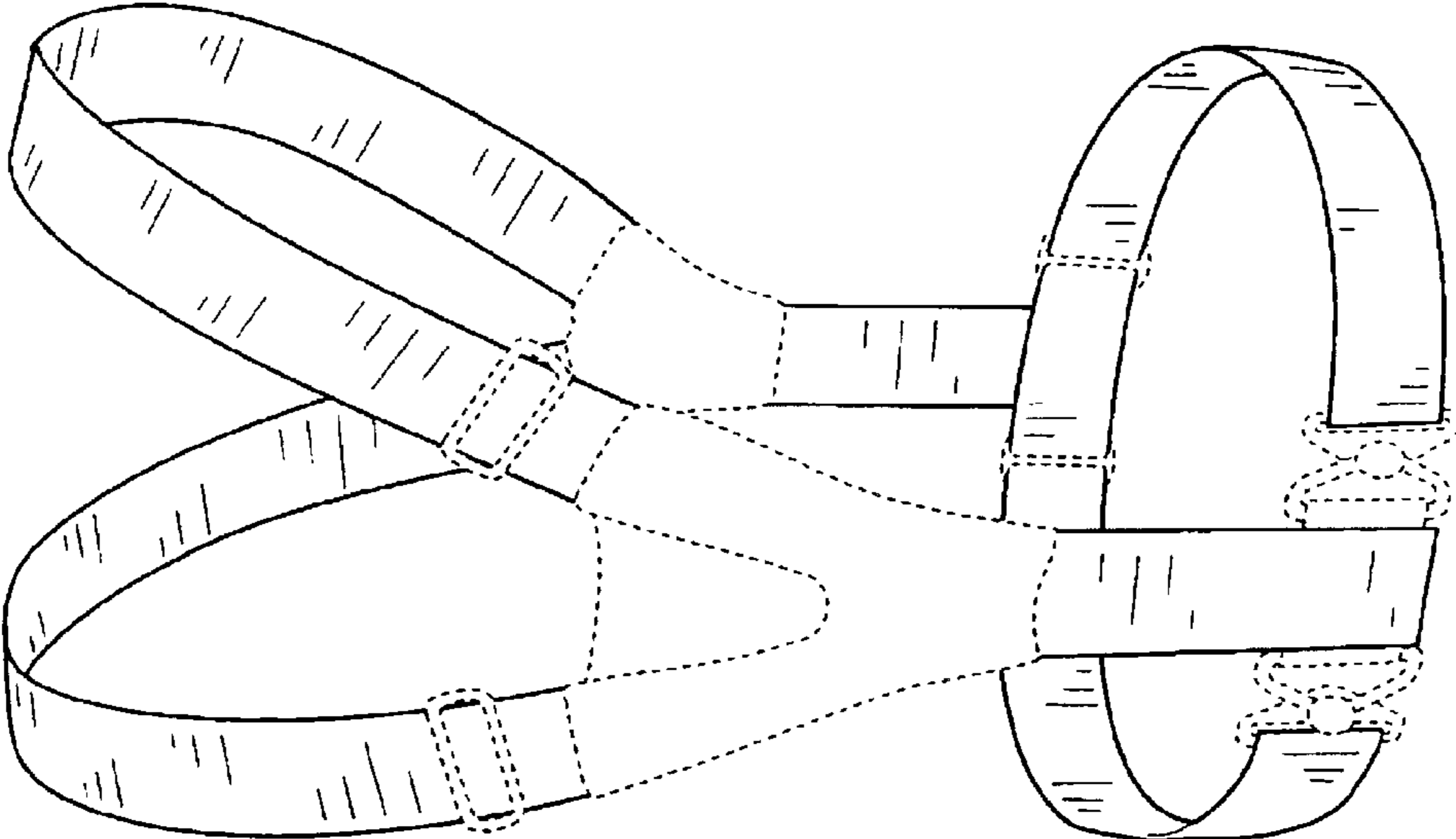

FIG. 19

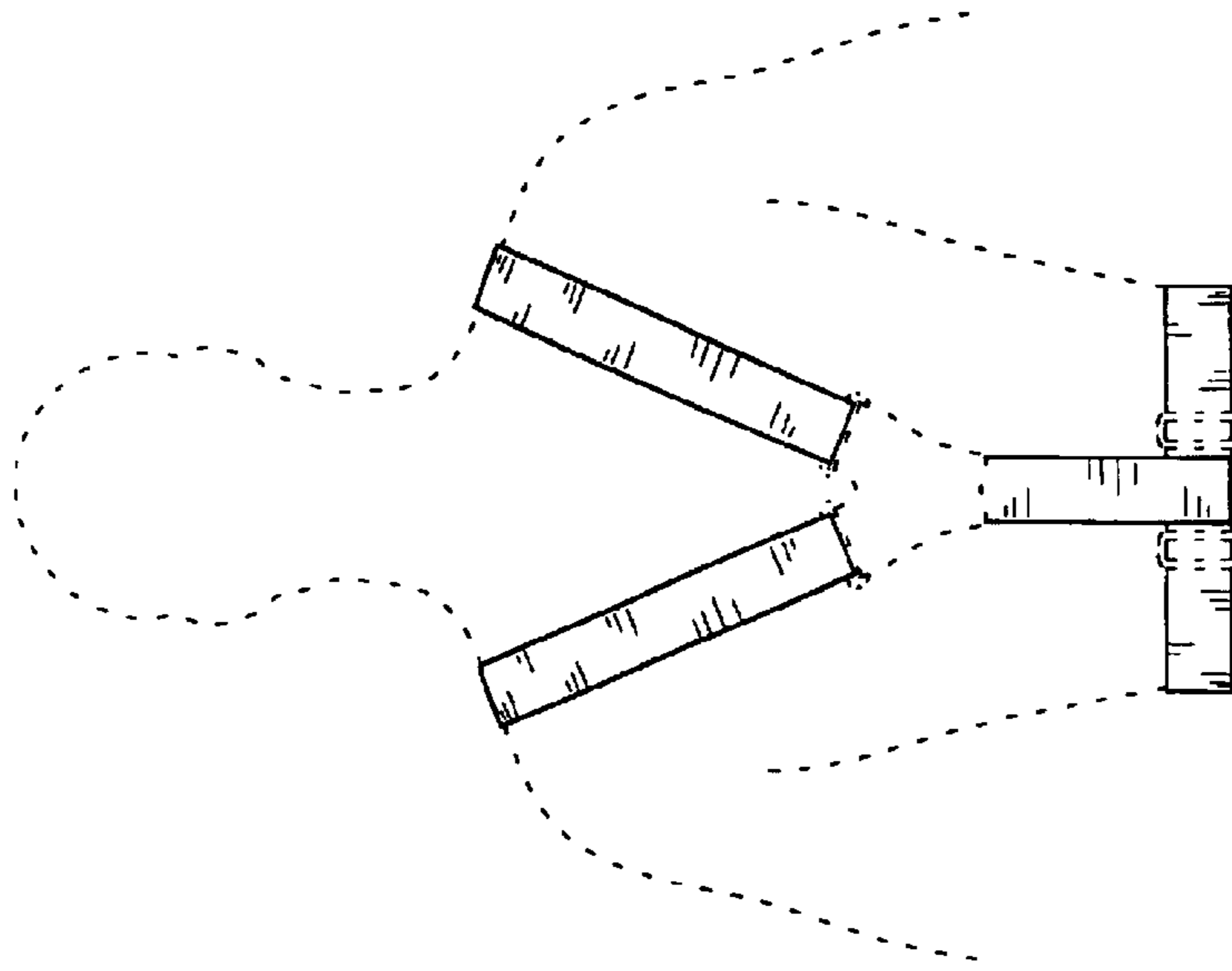

FIG. 21

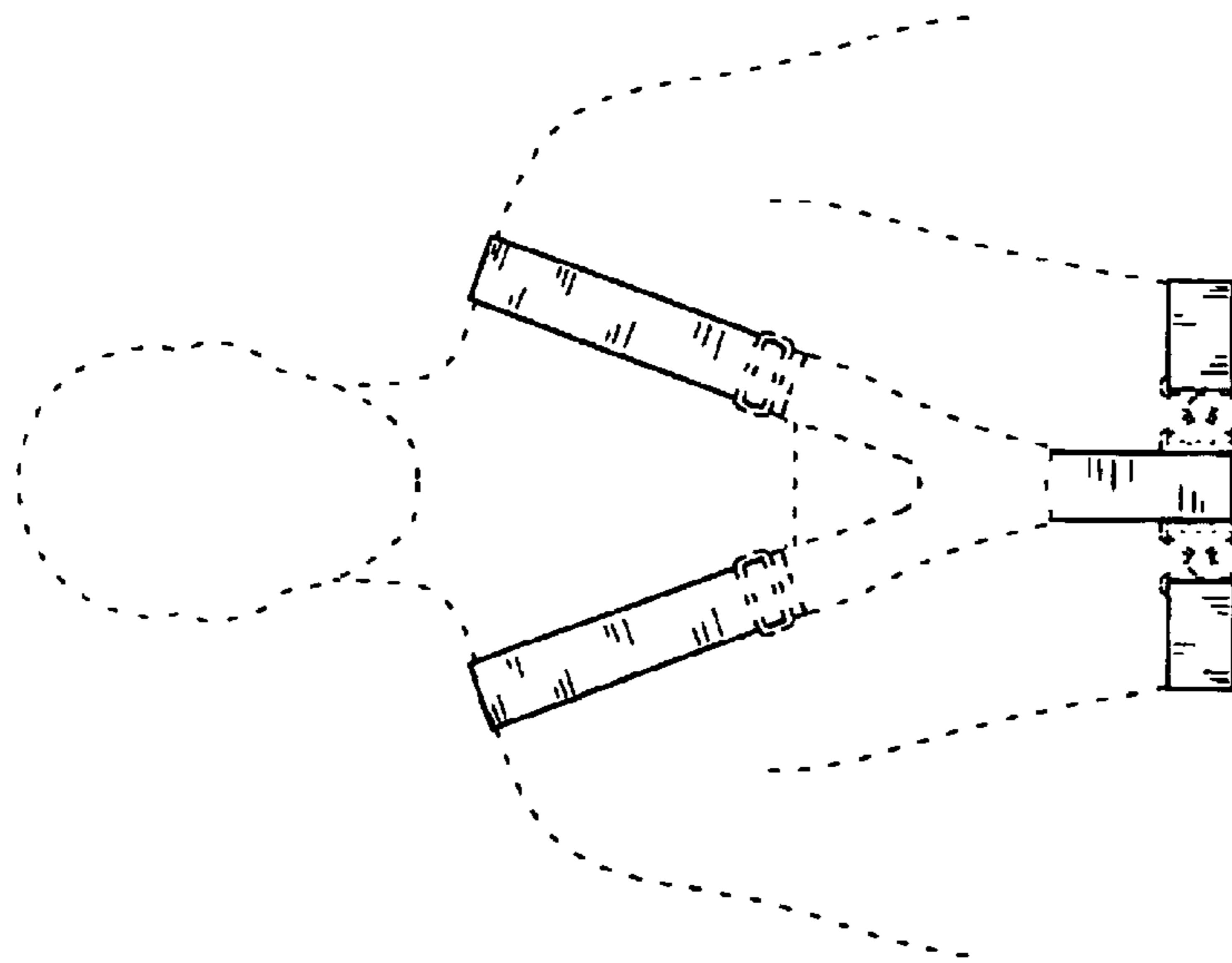

FIG. 20

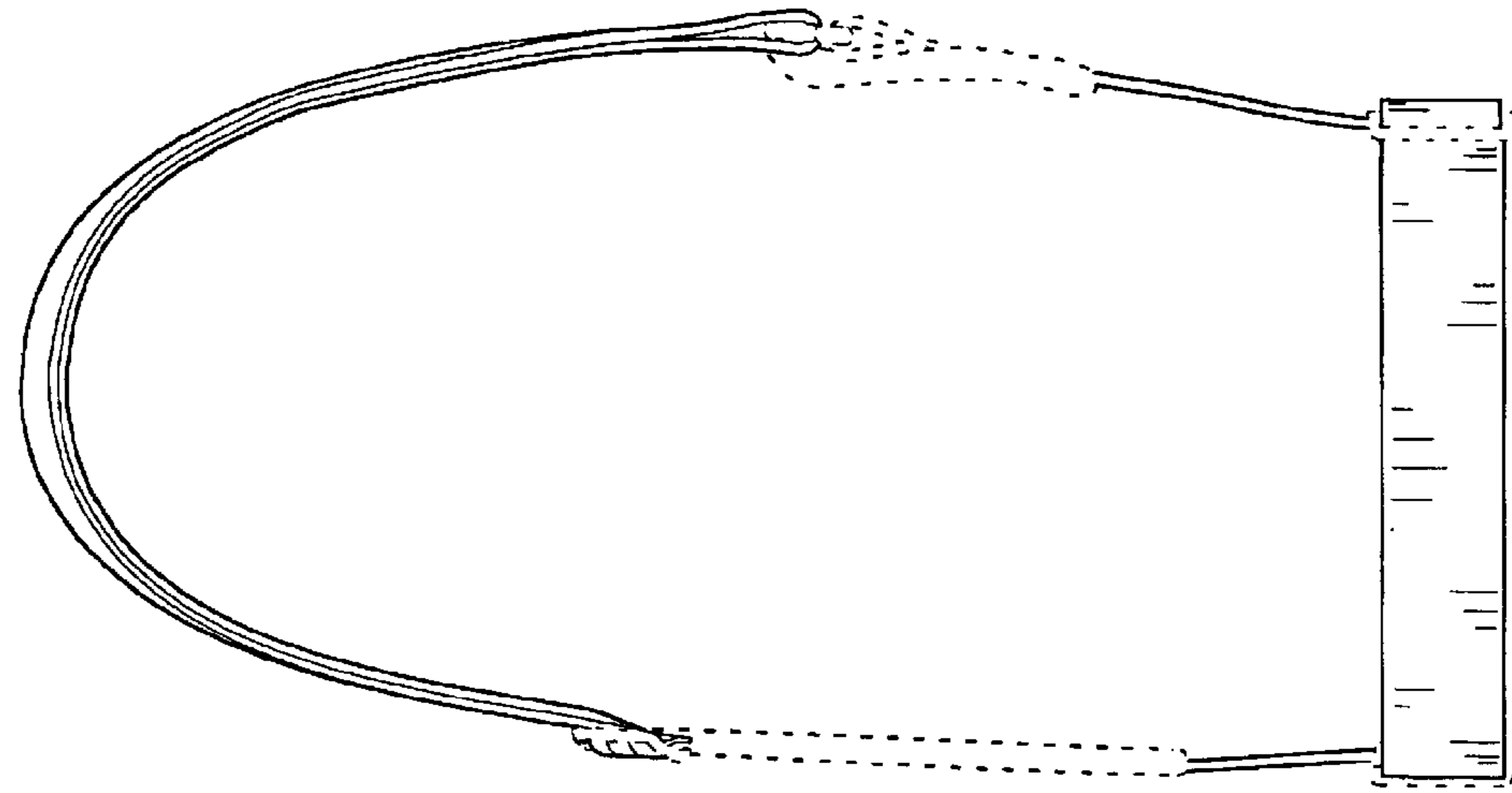

FIG. 24

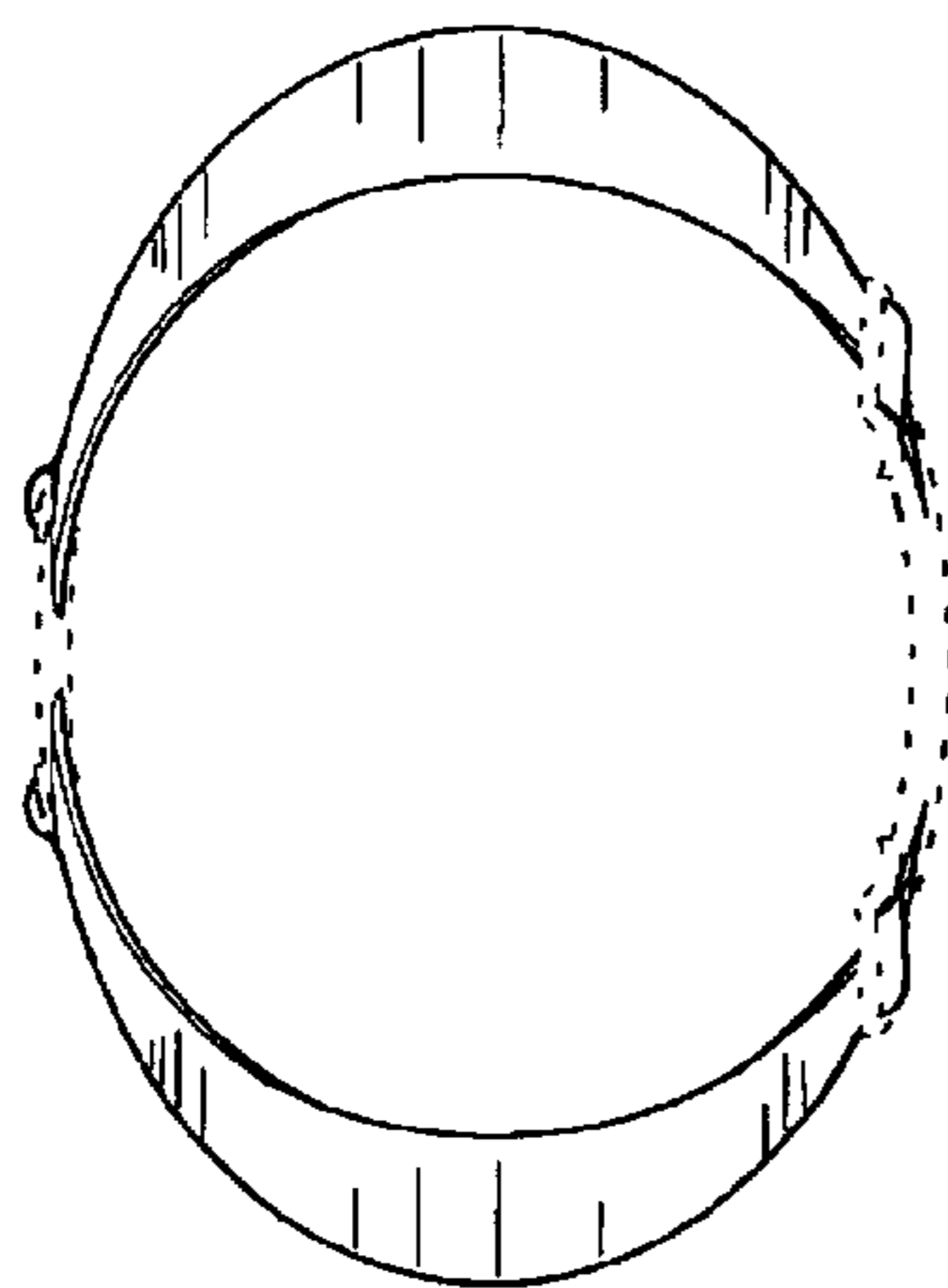

FIG. 22

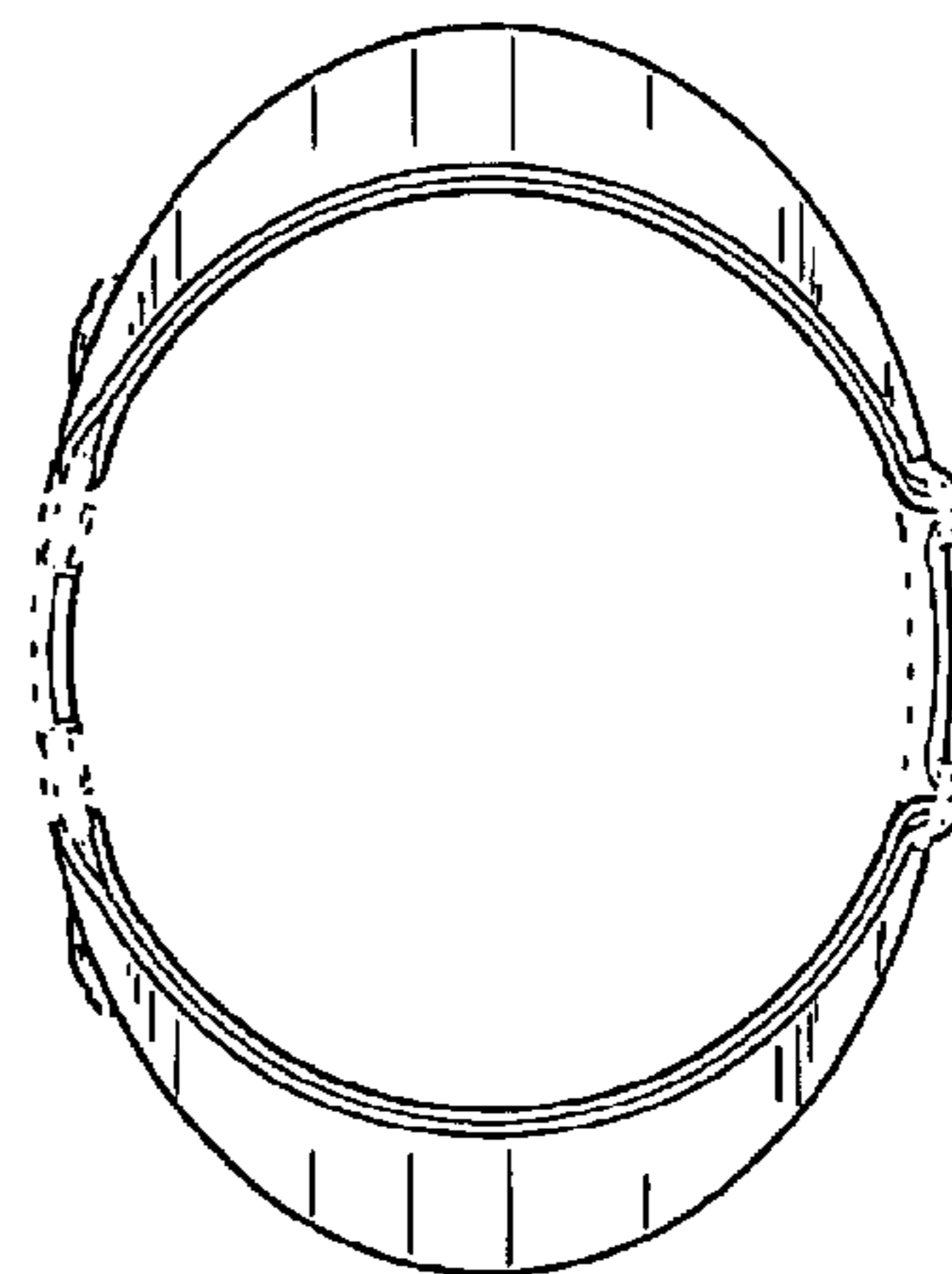

FIG. 23

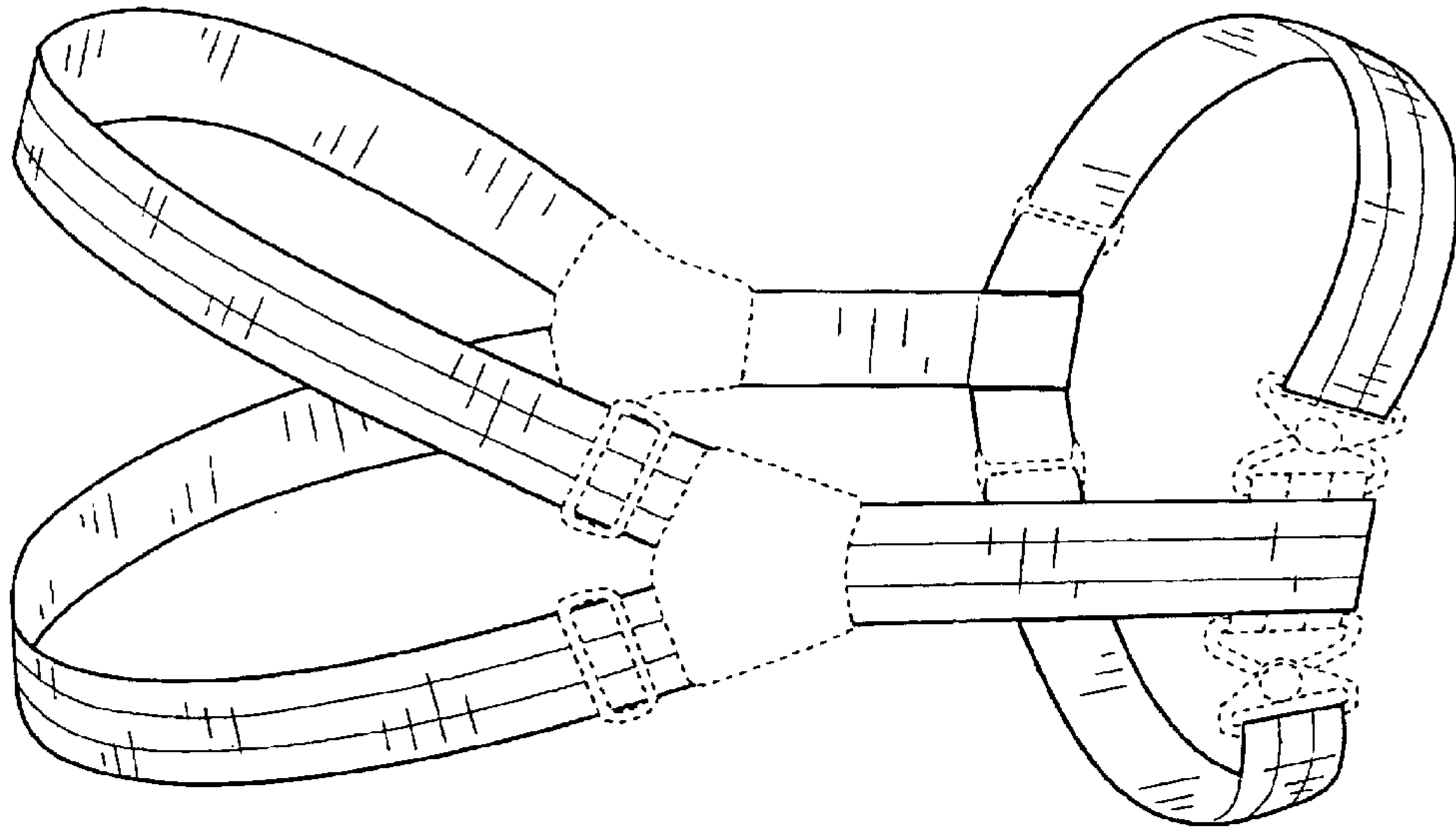

FIG. 25

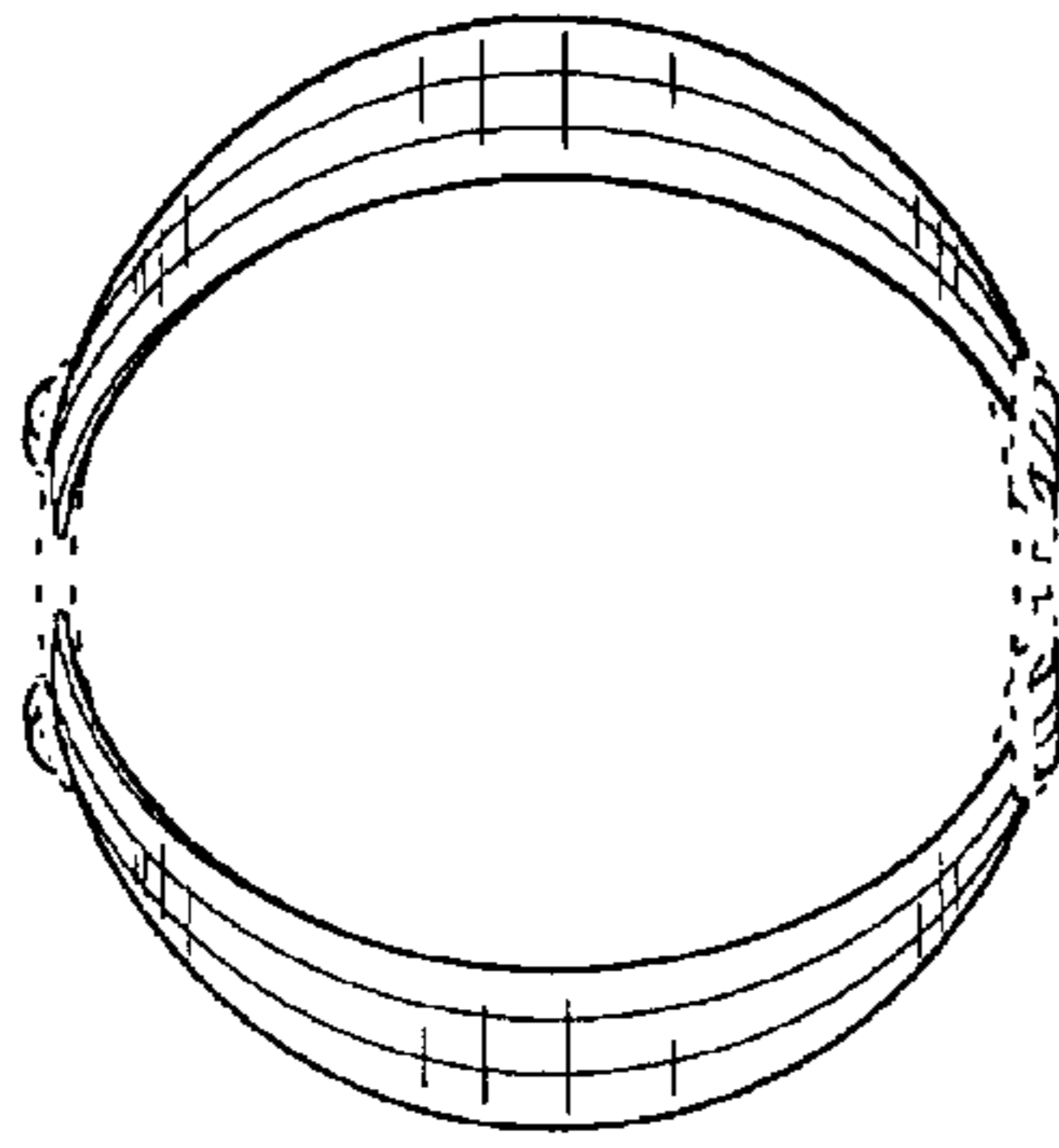

FIG. 27

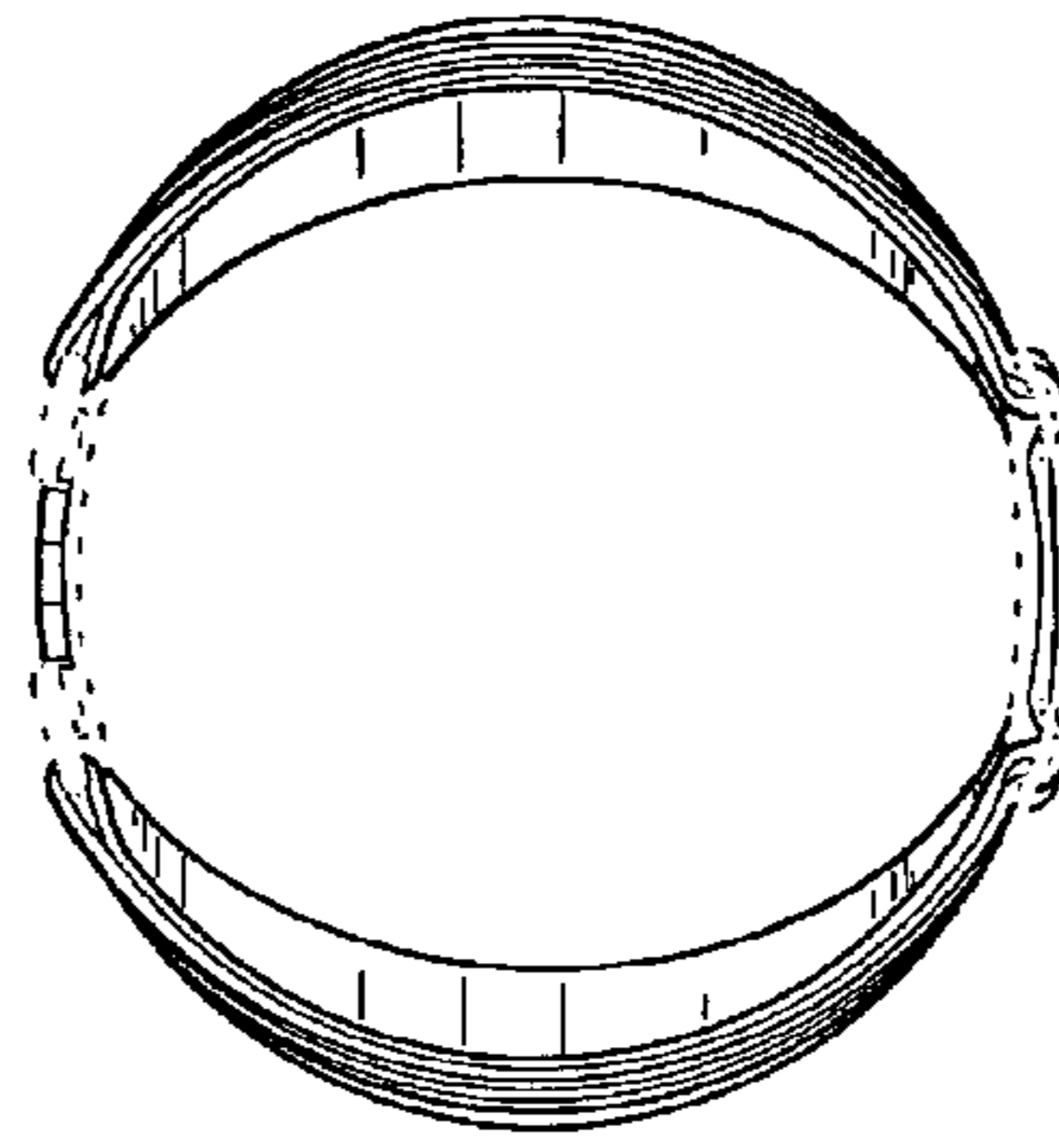

FIG. 28

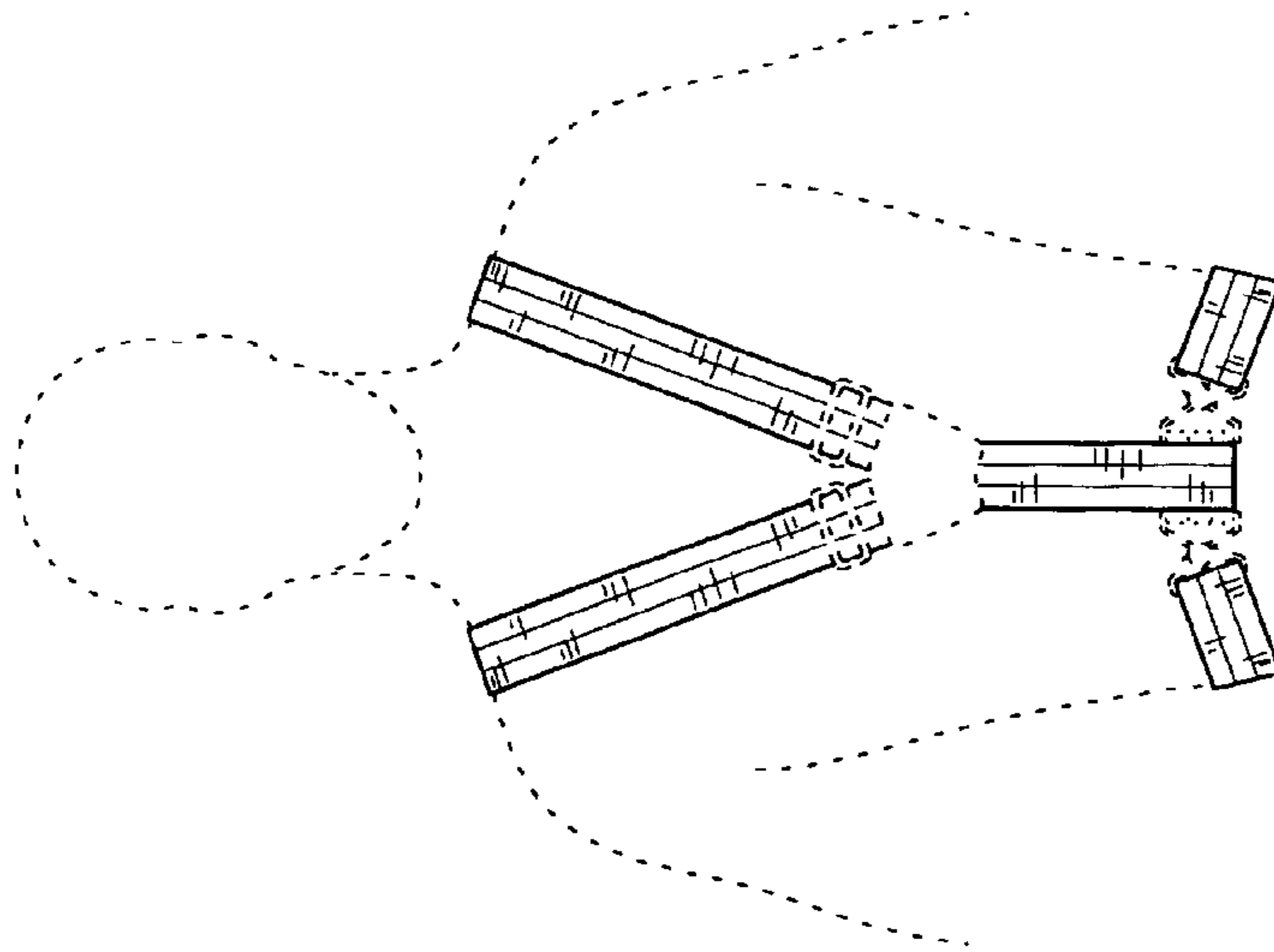

FIG. 26

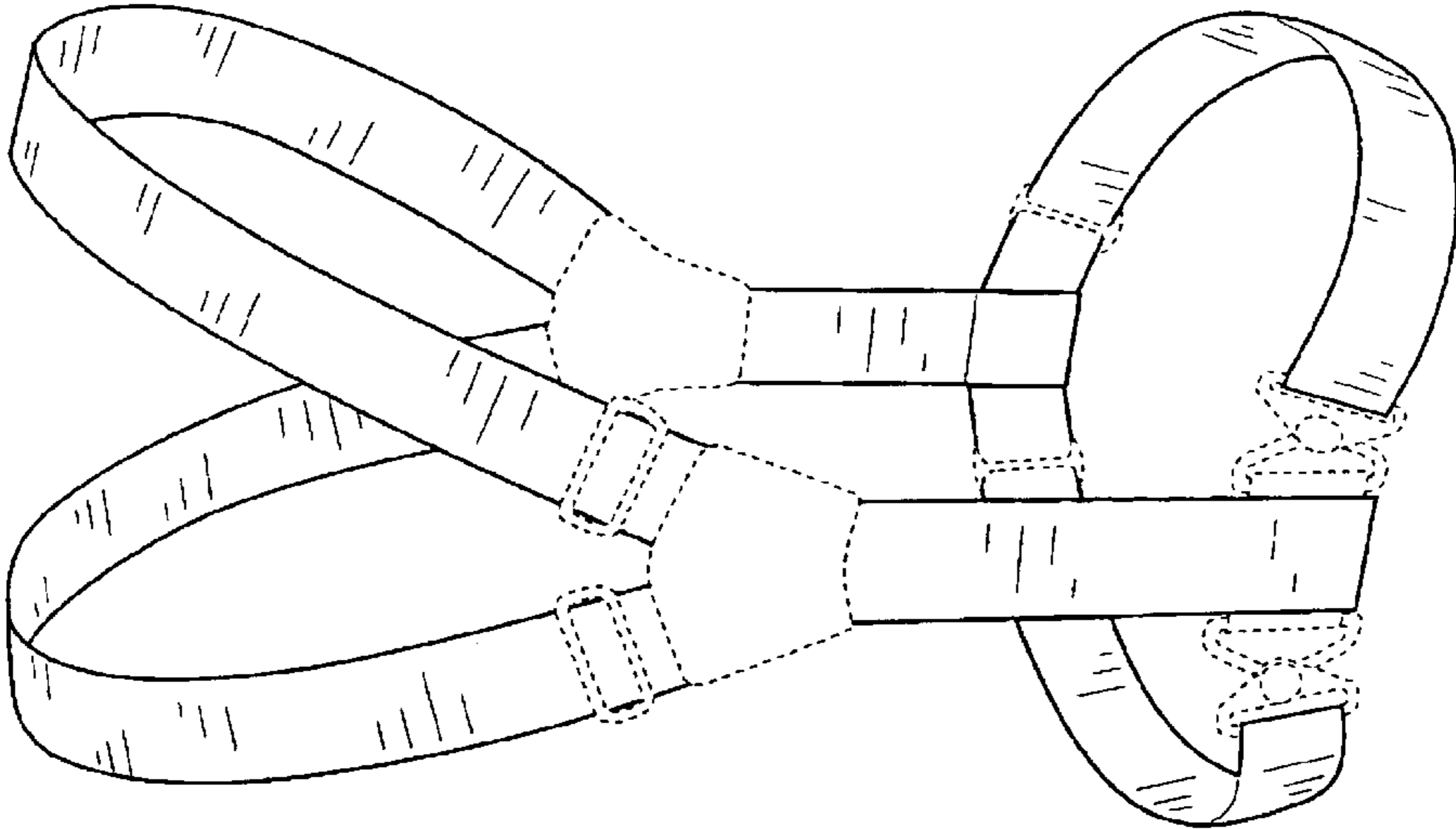

FIG. 29

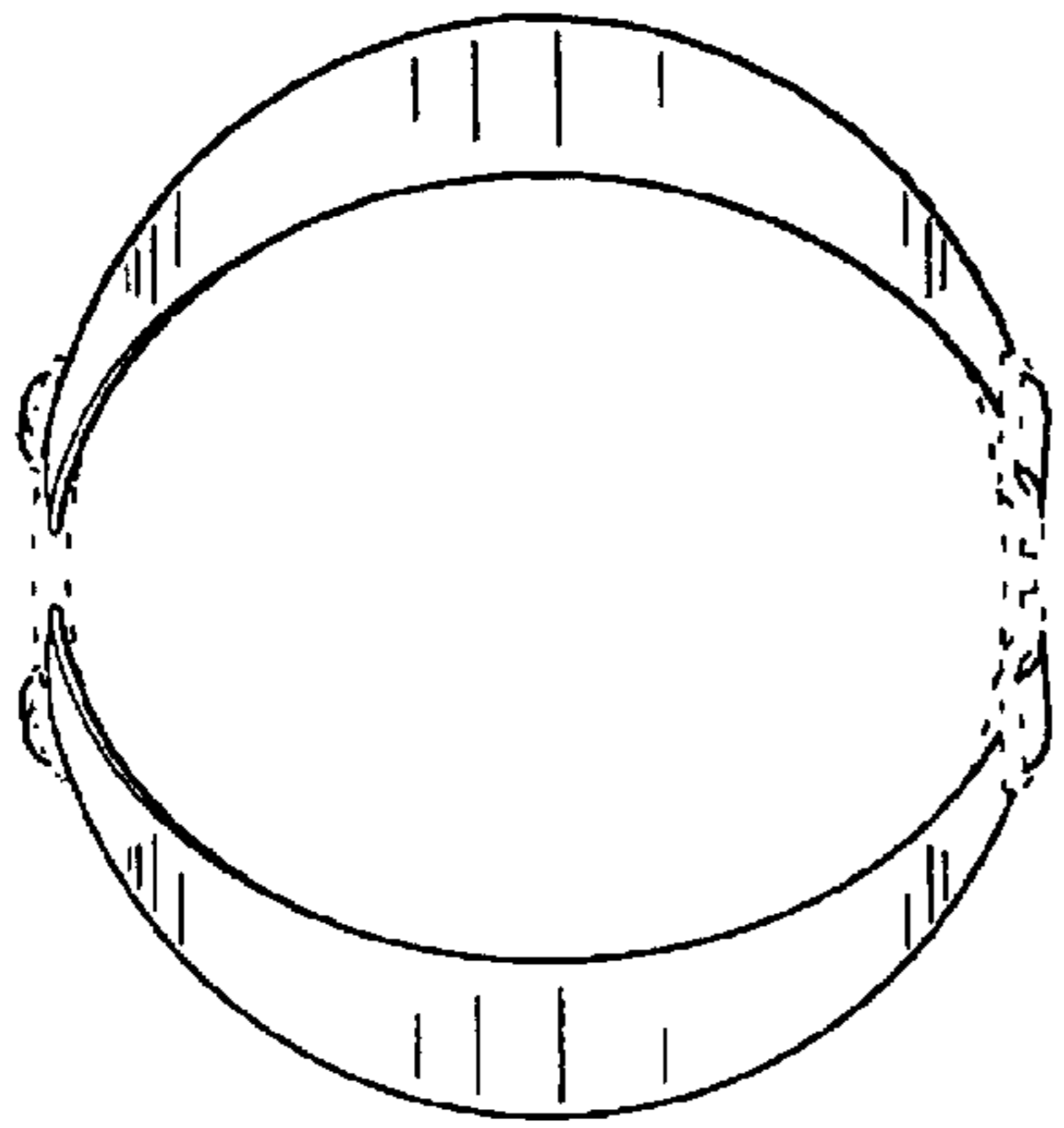

FIG. 31

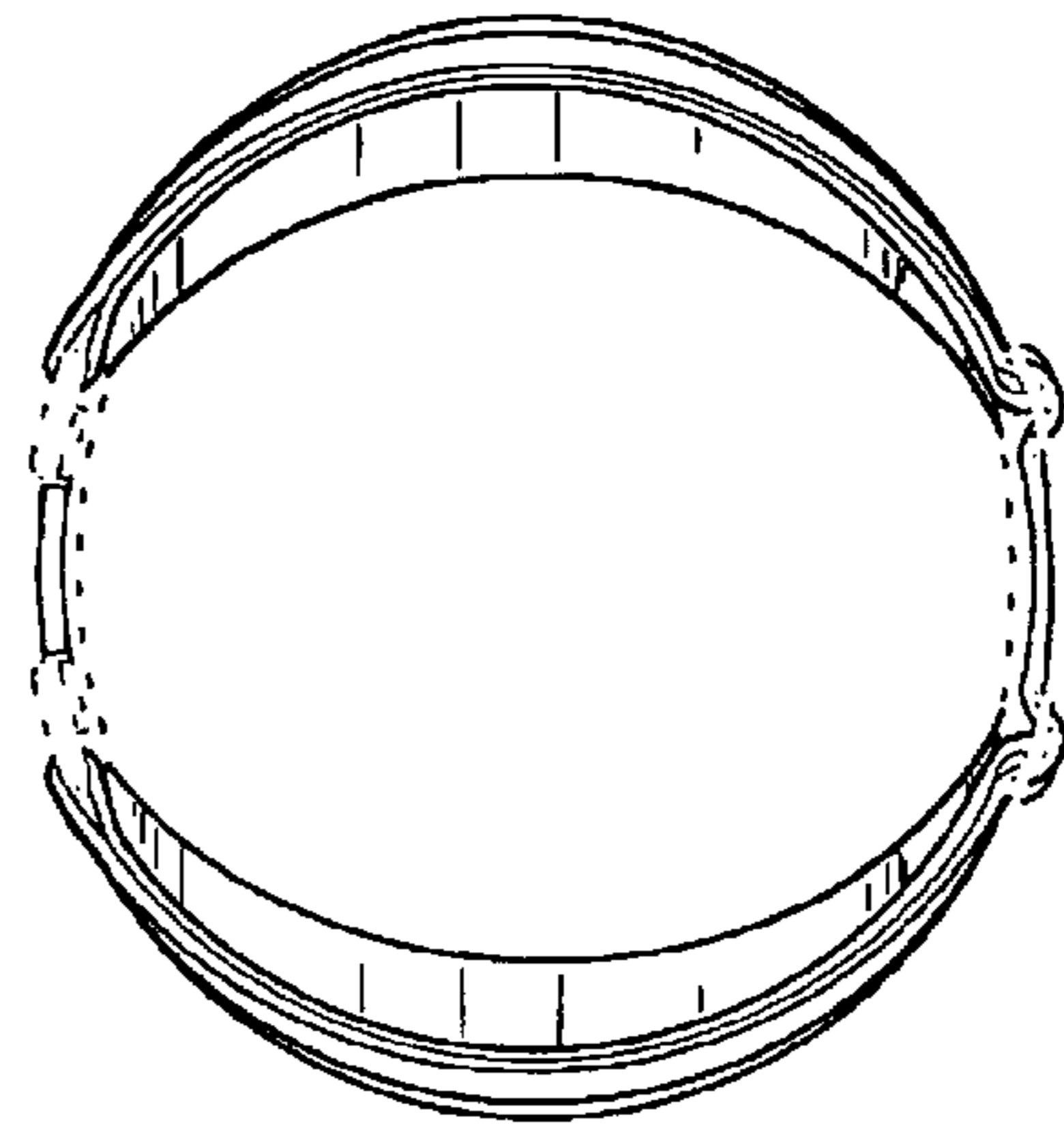

FIG. 32

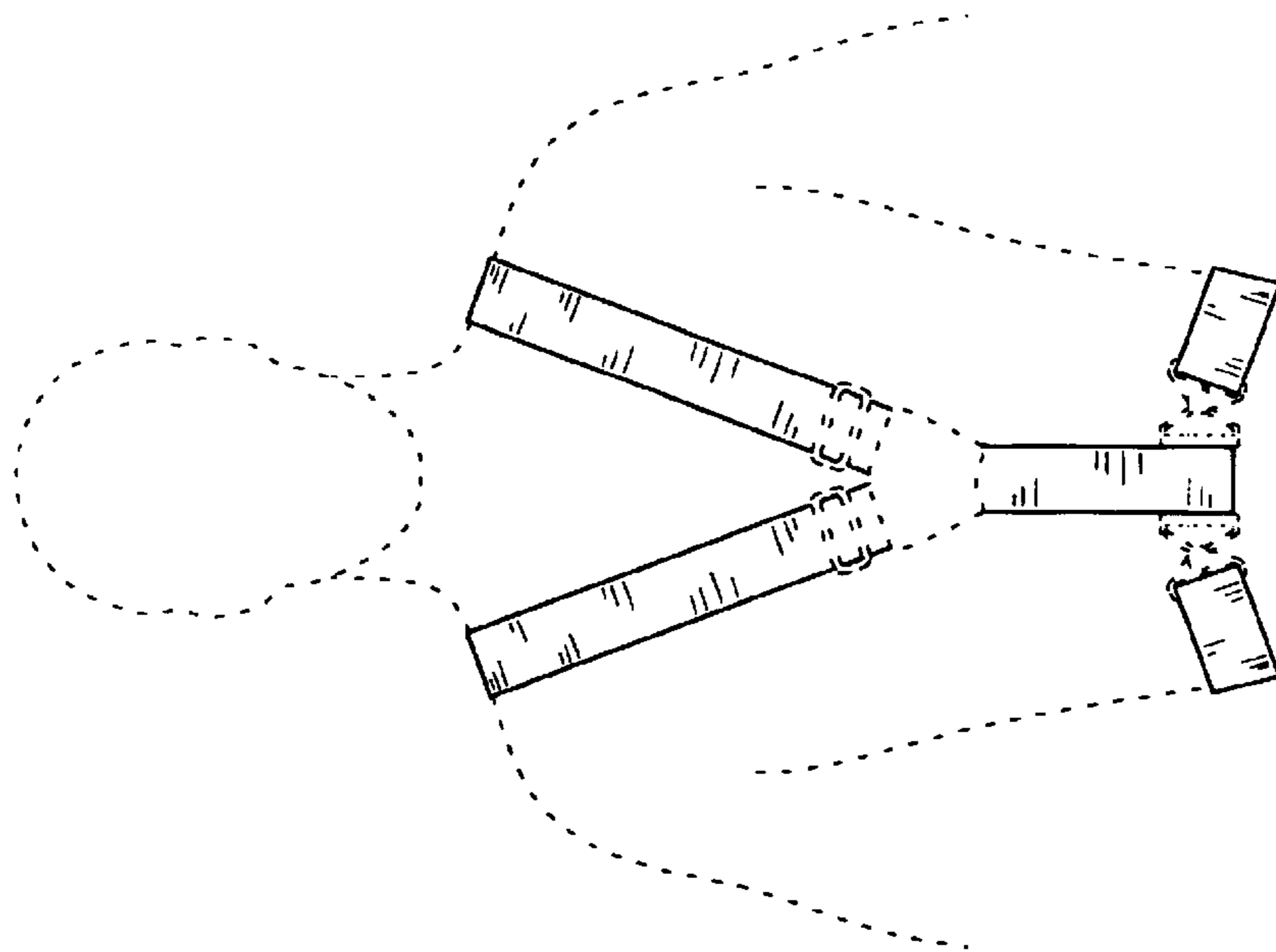

FIG. 30

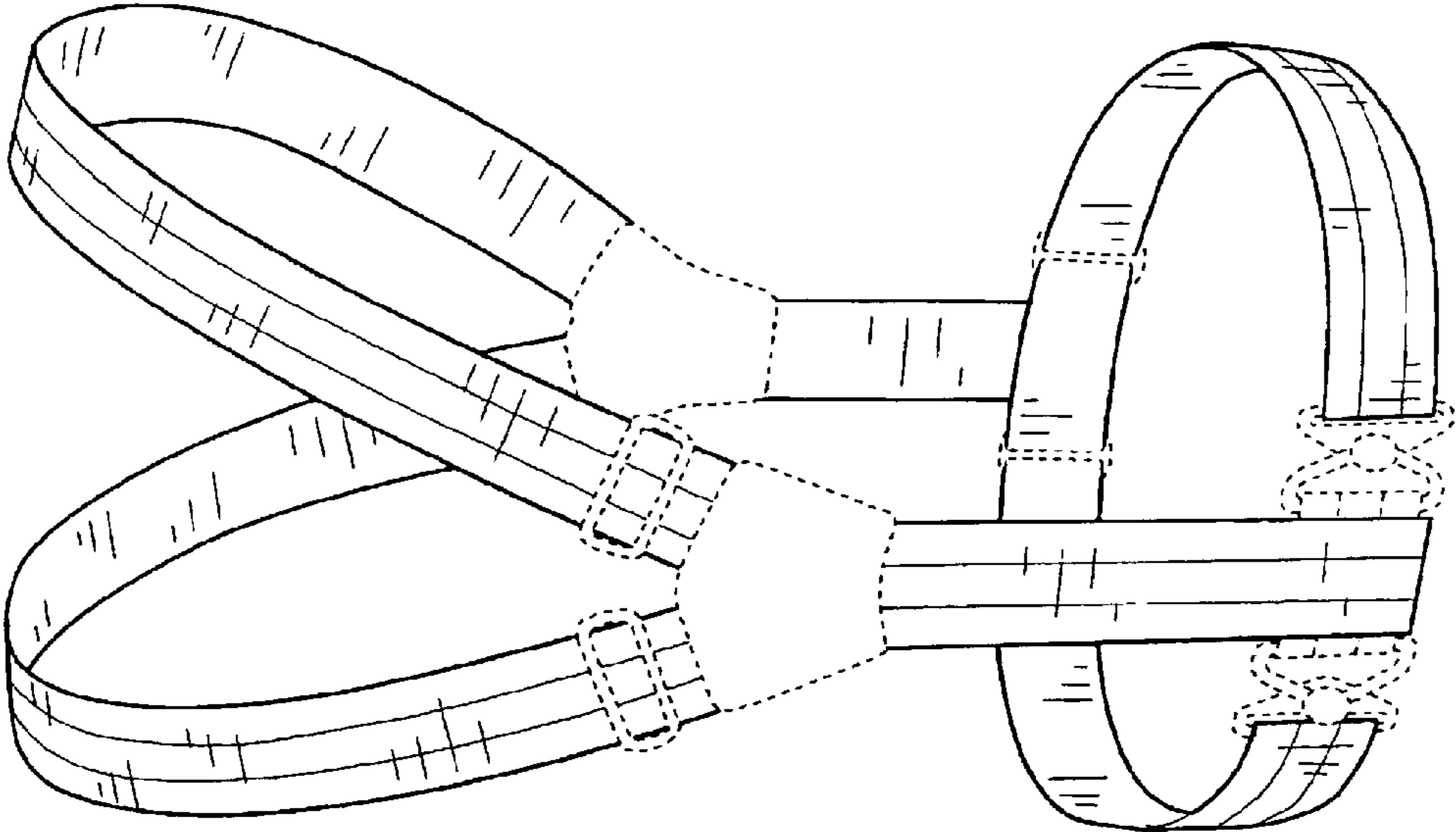

FIG. 33

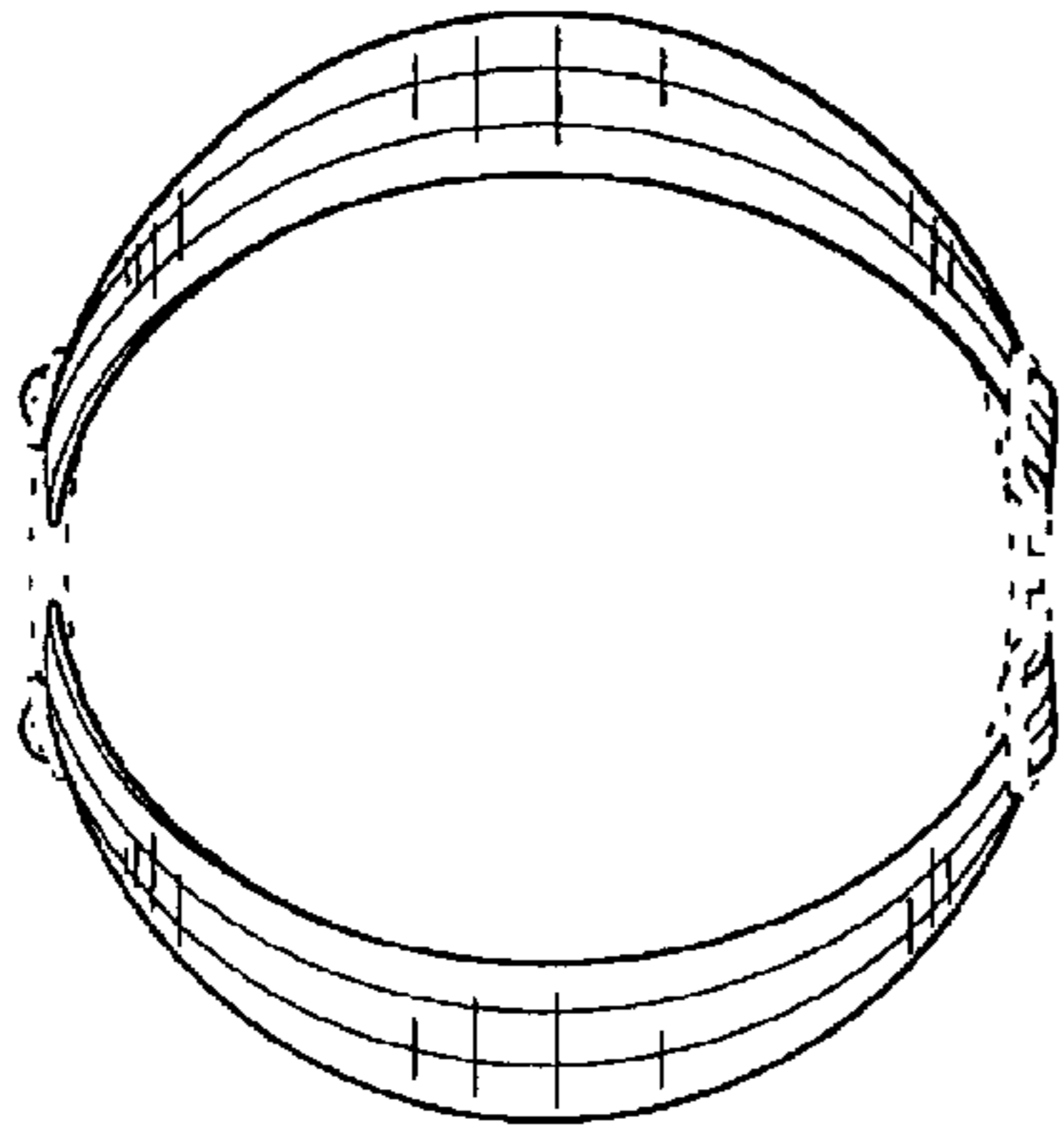

FIG. 35

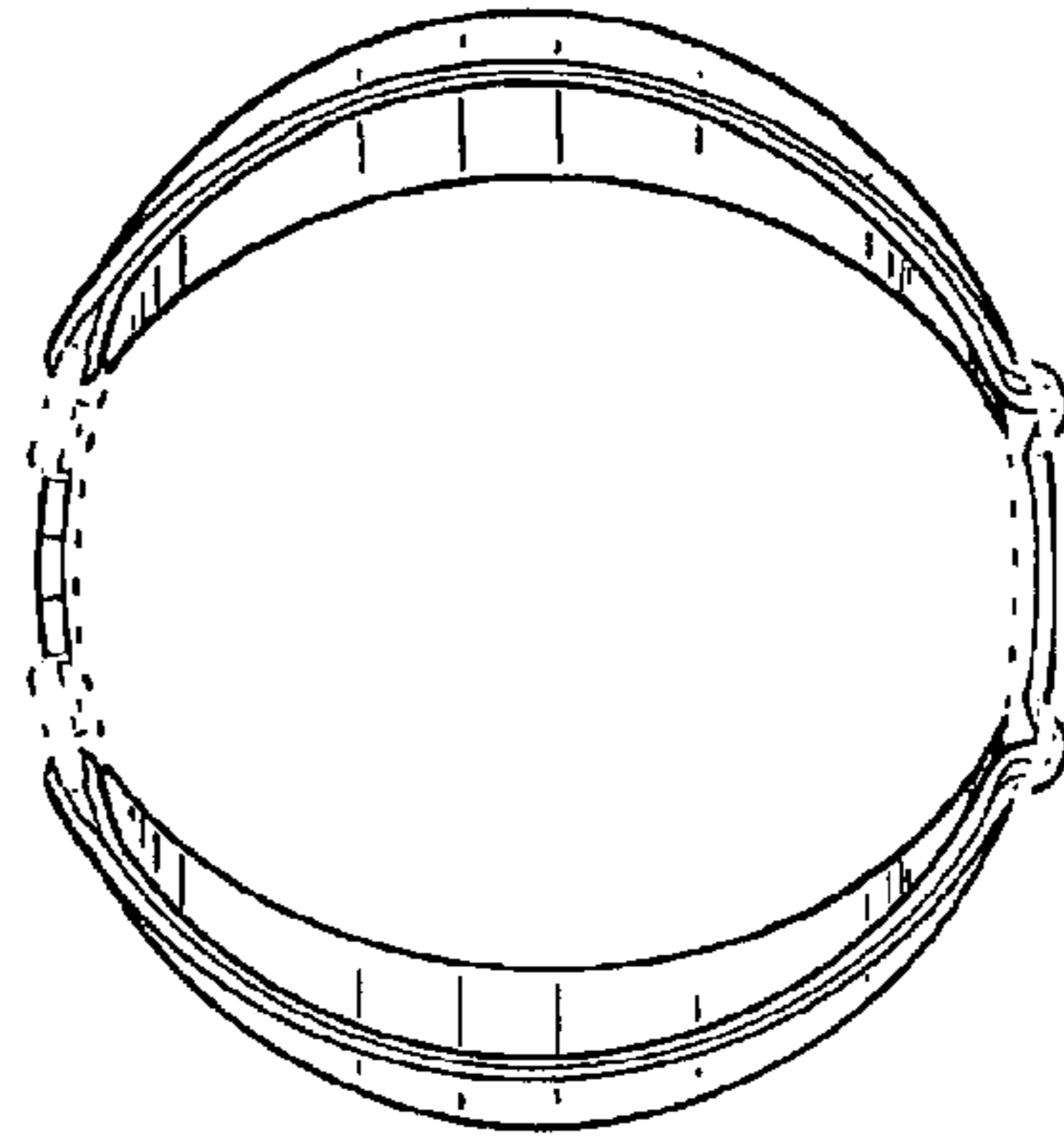

FIG. 36

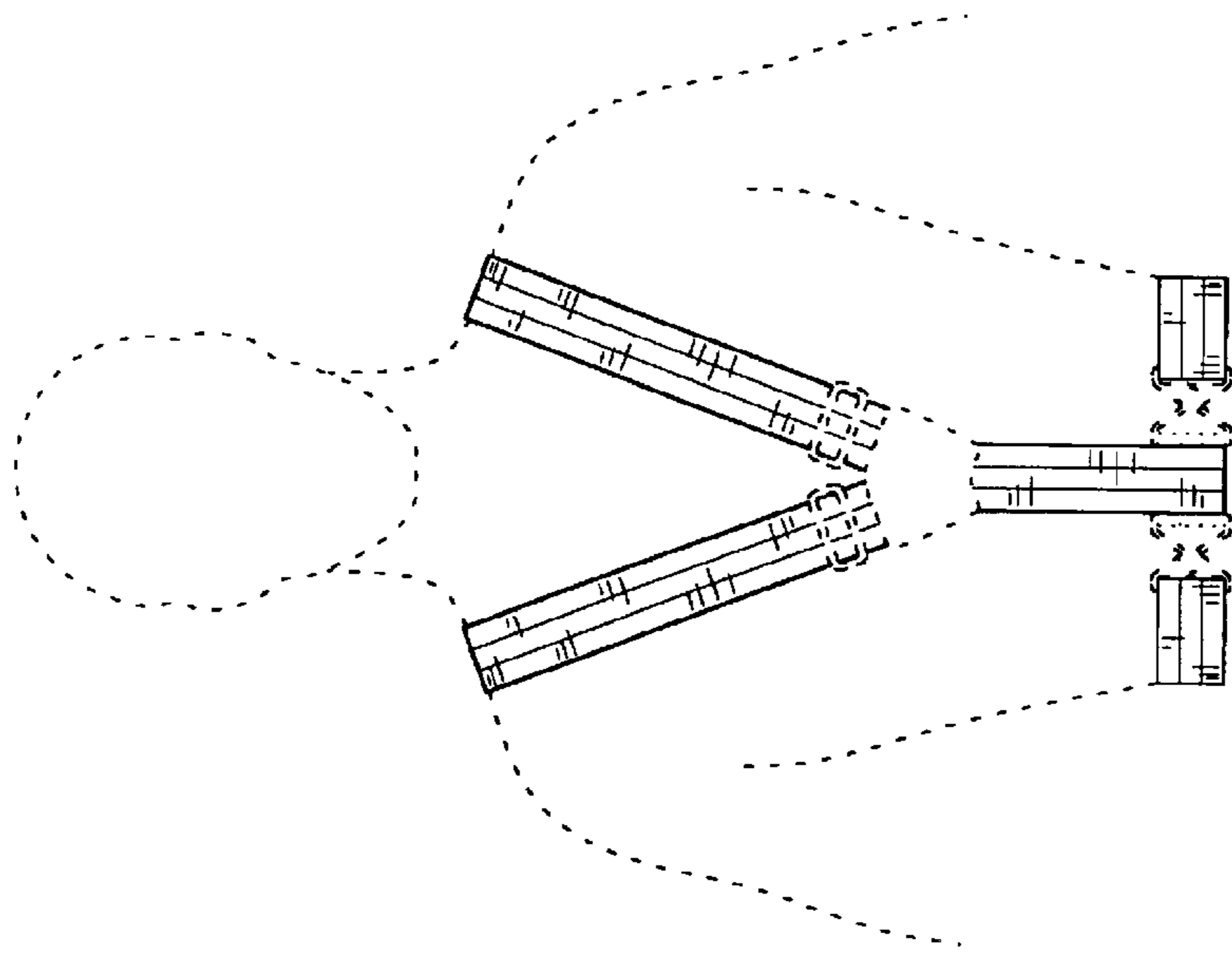

FIG. 34

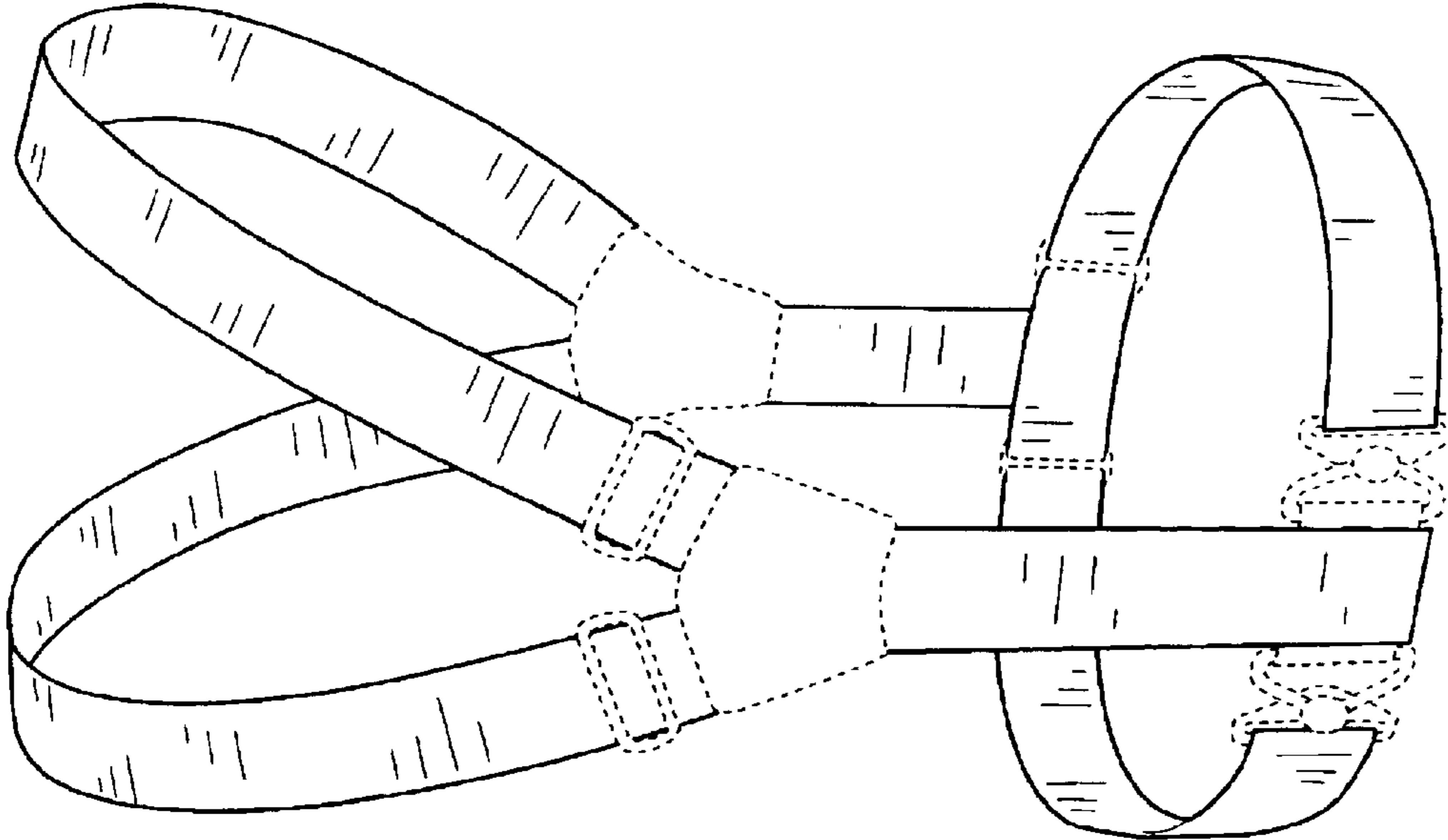

FIG. 37

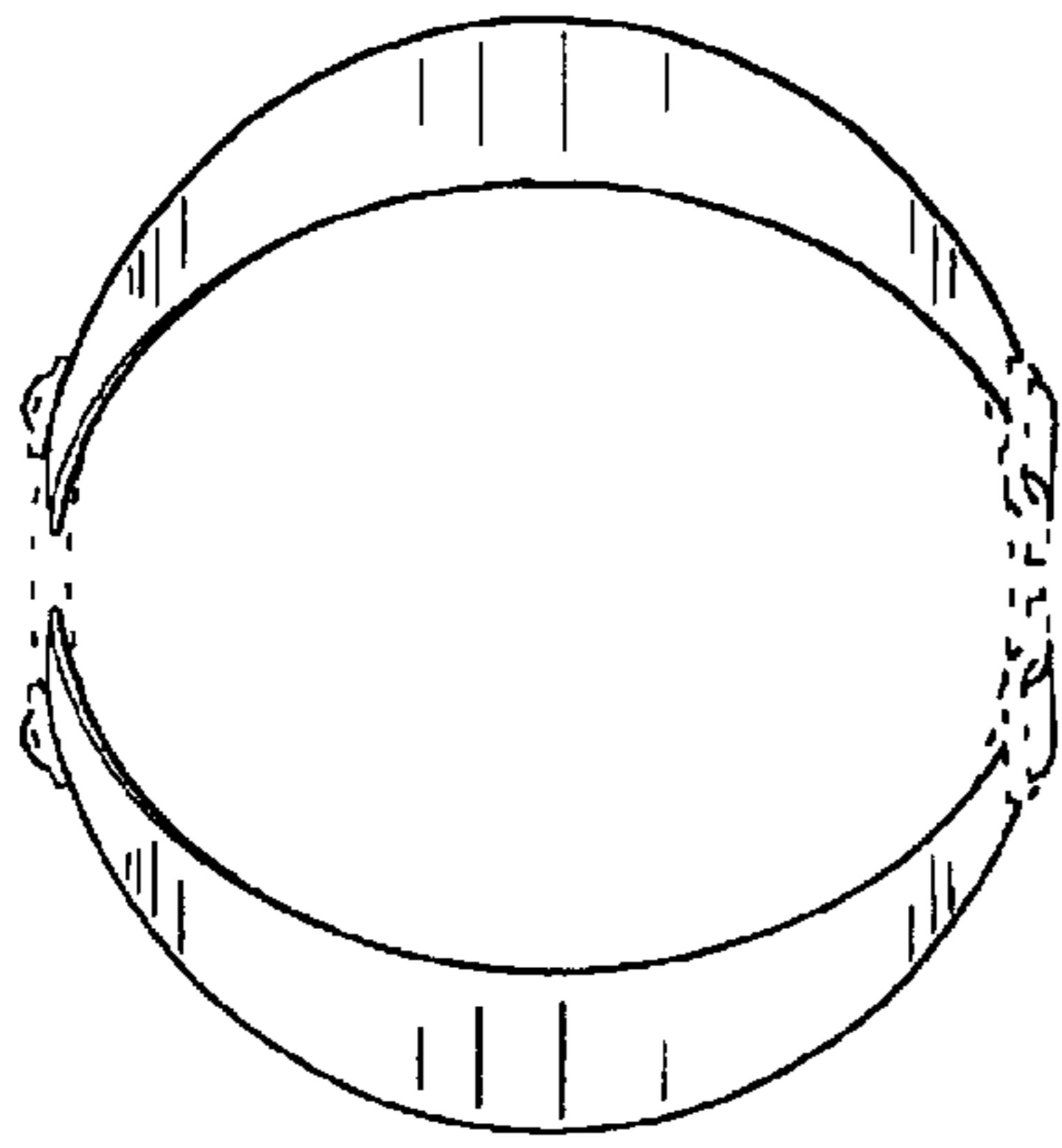

FIG. 39

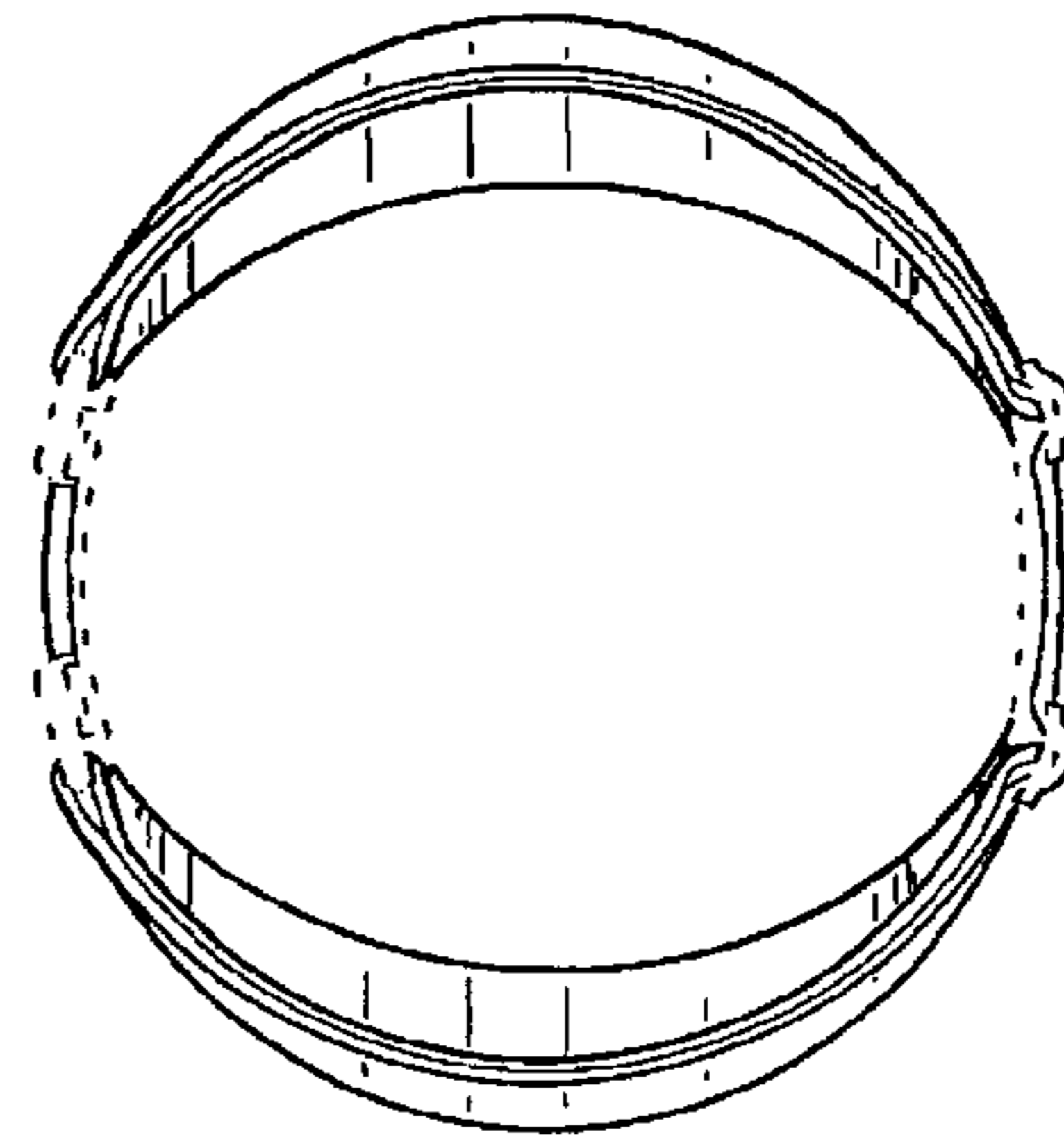

FIG. 40

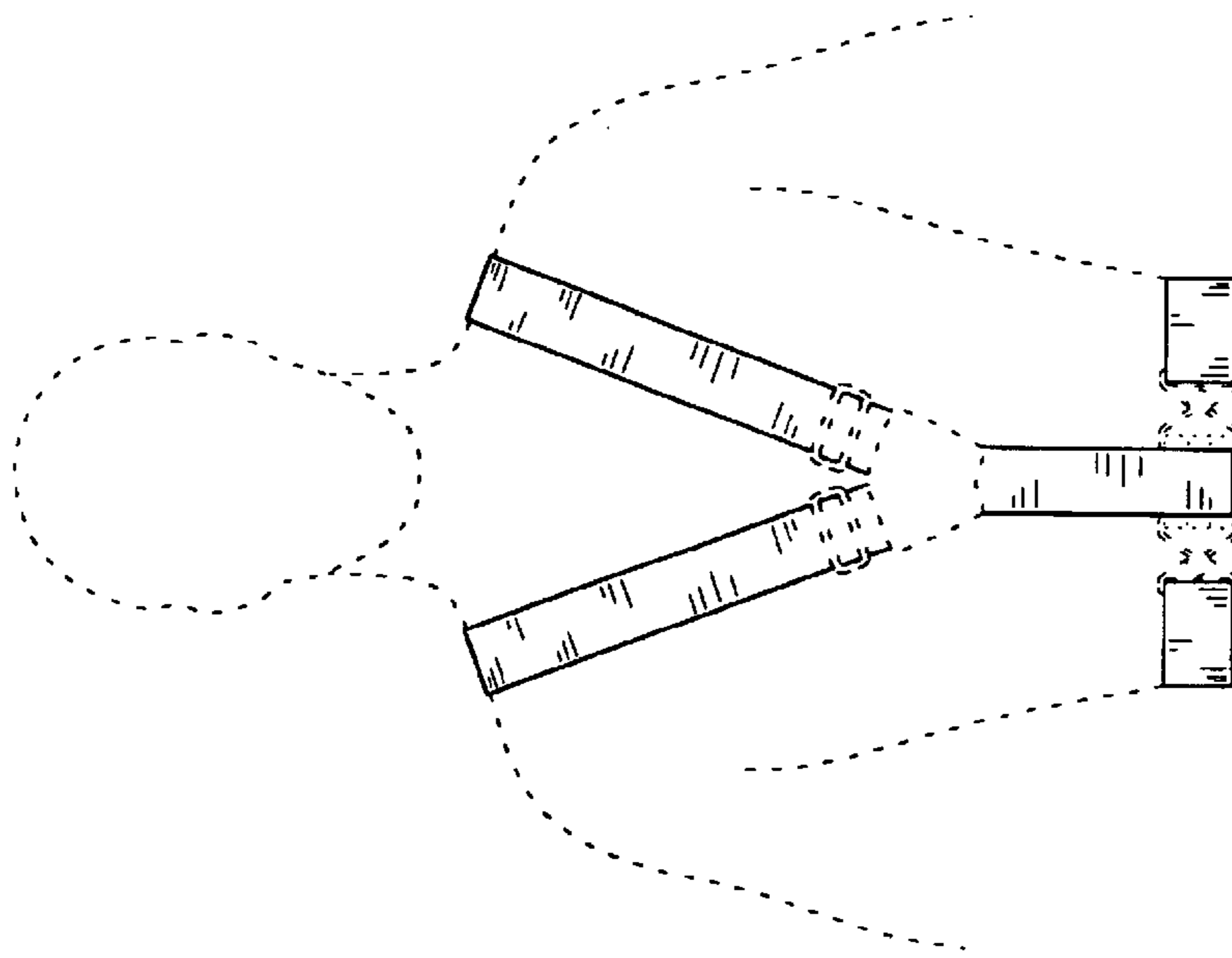

FIG. 38

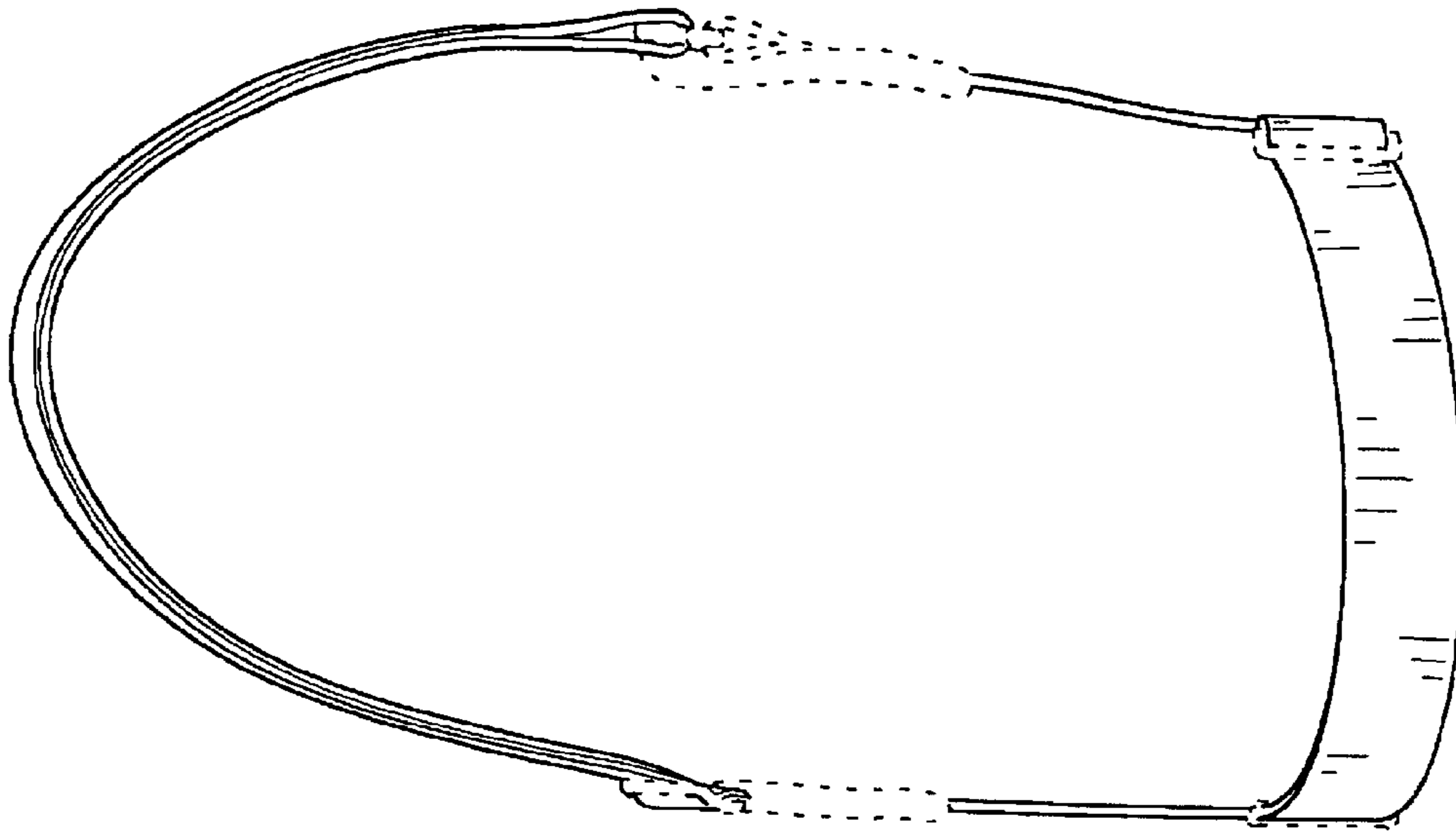

FIG. 42

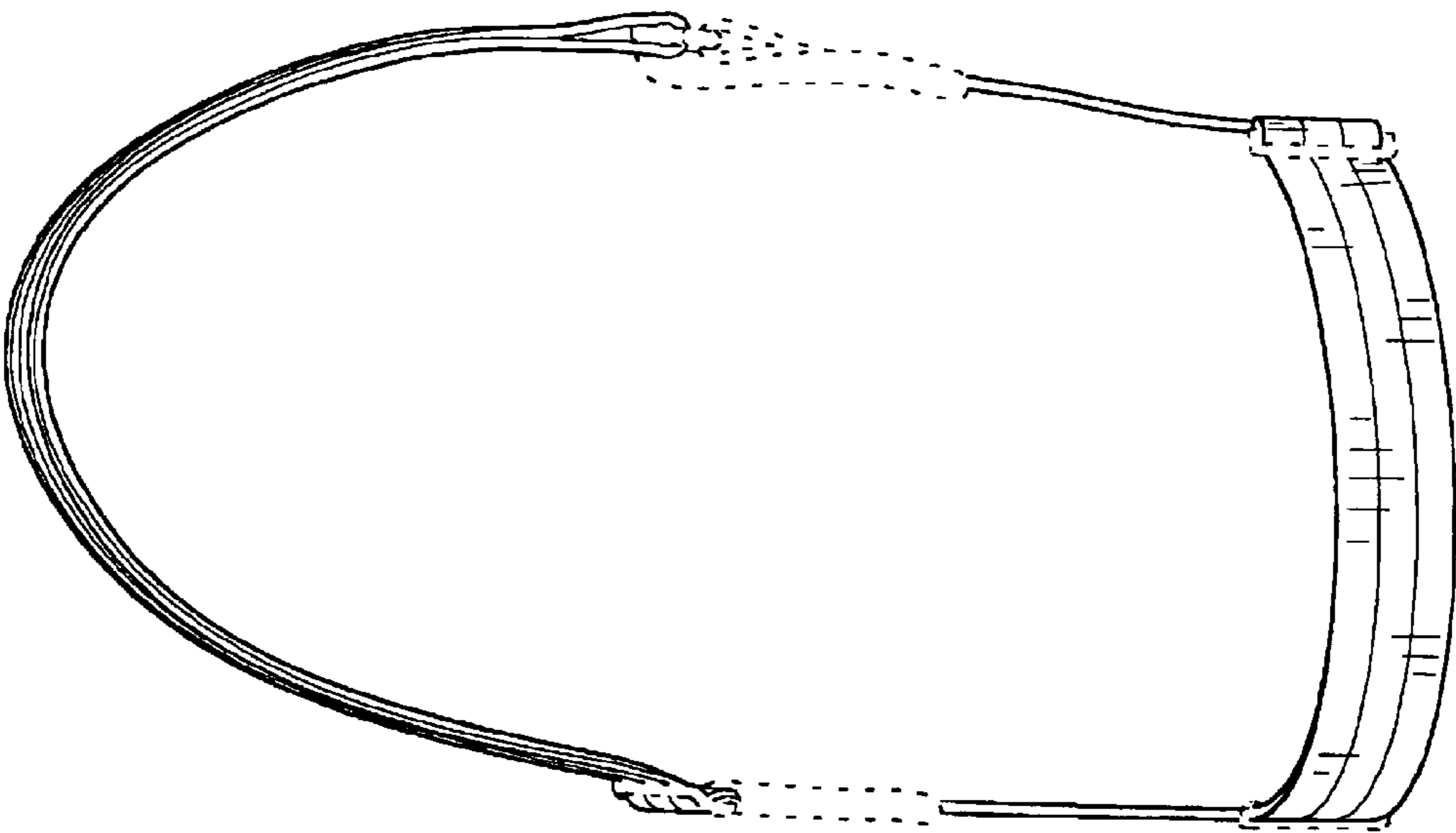

FIG. 41

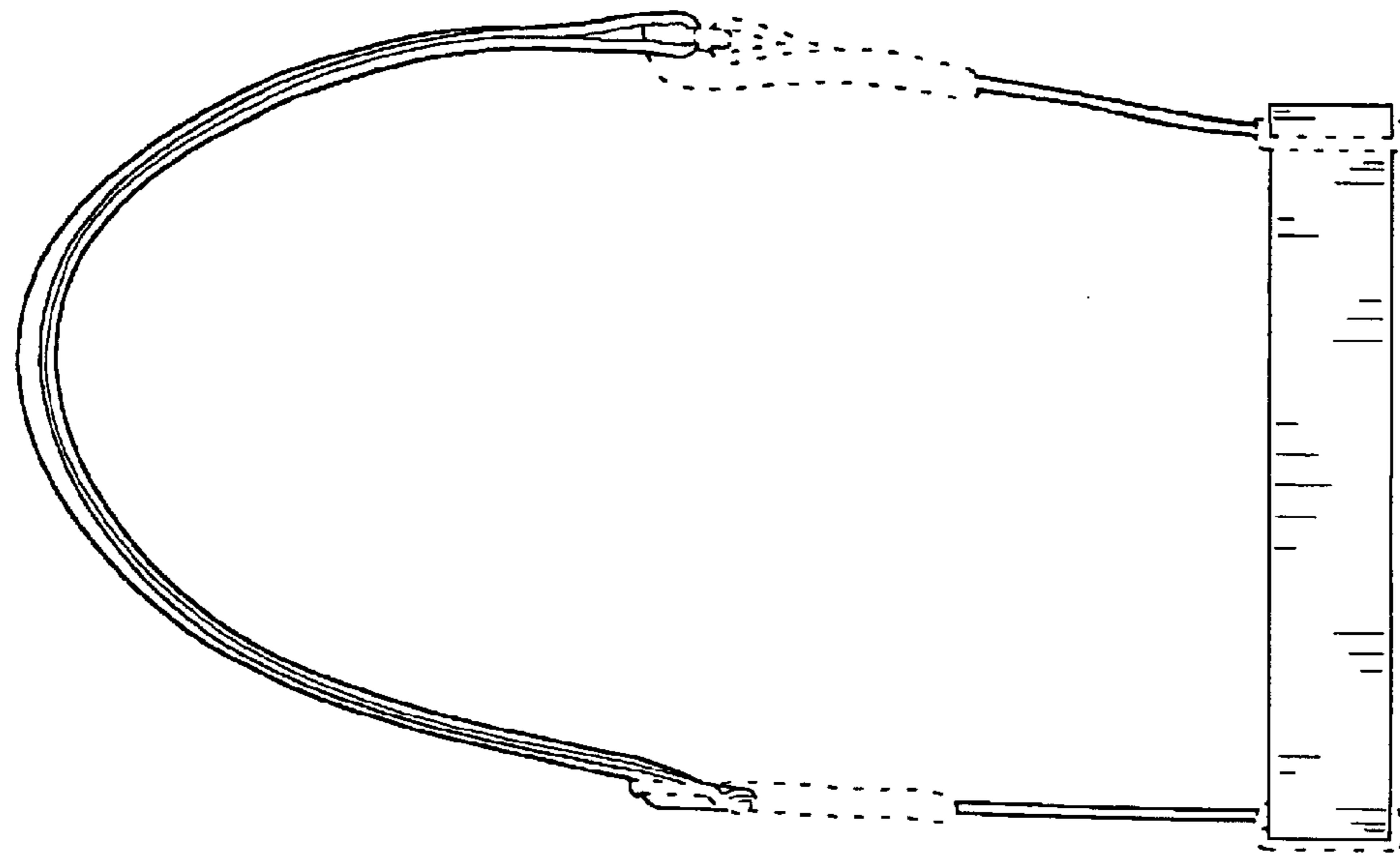

FIG. 44

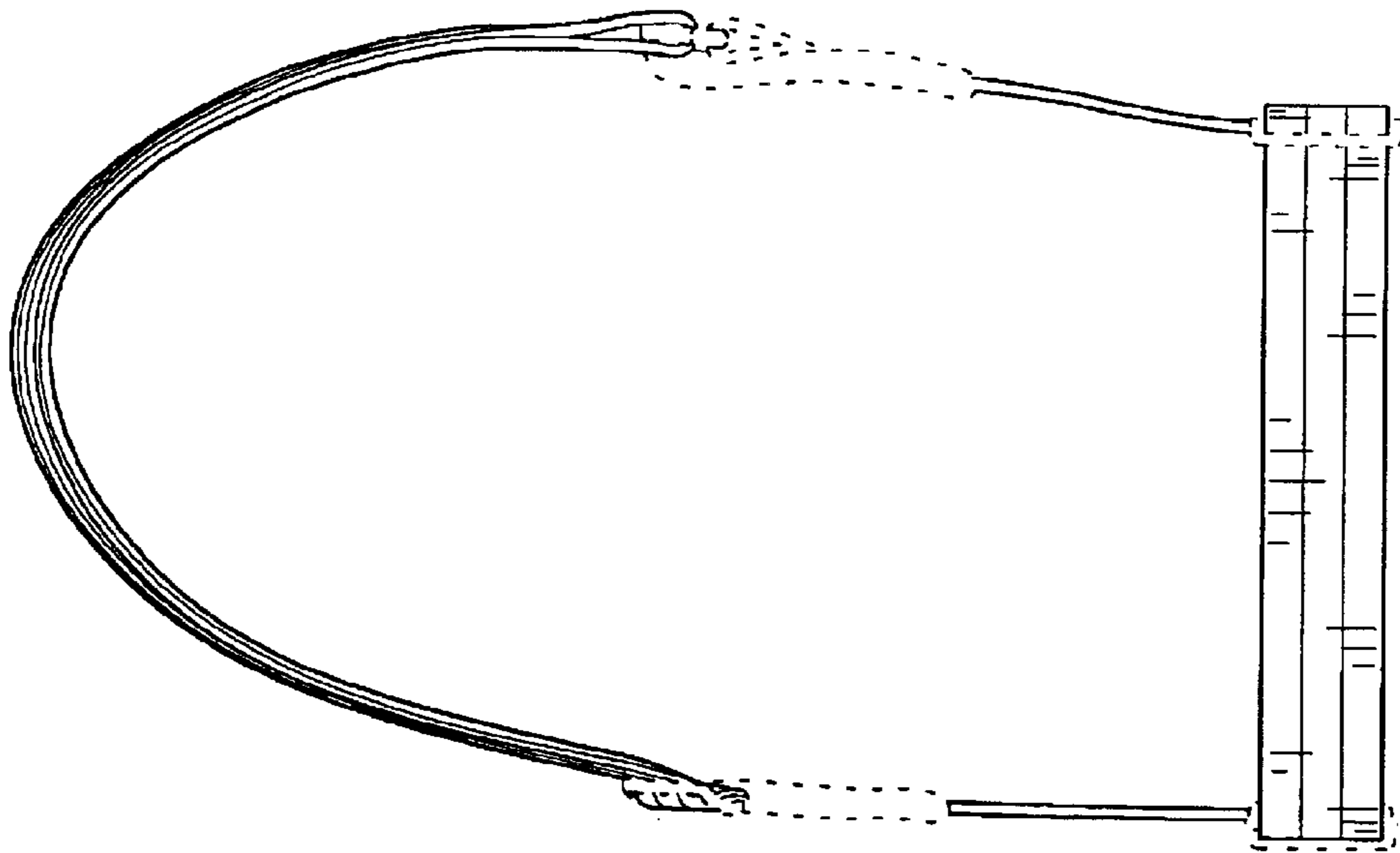

FIG. 43