



US00D512531S

(12) **United States Design Patent**  
**Khubani et al.**

(10) **Patent No.:** **US D512,531 S**  
(45) **Date of Patent:** **\*\* Dec. 6, 2005**

(54) **ELECTRIC RAZOR**

(75) Inventors: **Anand Khubani**, Towaco, NJ (US);  
**Aaron Szymanski**, Thomaston, CT (US)

(73) Assignee: **Ideavillage Products Corp.**, Fairfield, NJ (US)

(\*\*) Term: **14 Years**

(21) Appl. No.: **29/216,819**

(22) Filed: **Nov. 9, 2004**

(51) **LOC (8) Cl.** ..... **28-03**

(52) **U.S. Cl.** ..... **D28/51**

(58) **Field of Search** ..... D28/49-54; 30/32,  
30/34.05, 34.1, 34.2, 35, 41.9, 43, 43.1-43.9,  
43.91, 43.92, 42, 44-46, 527

(56) **References Cited**

**U.S. PATENT DOCUMENTS**

D339,655 S	*	9/1993	Sulik	.....	D28/53
D342,345 S	*	12/1993	Yonezawa	.....	D28/53
D377,847 S	*	2/1997	Sulik	.....	D28/49

\* cited by examiner

*Primary Examiner*—Jennifer Rivard  
(74) *Attorney, Agent, or Firm*—Robert L. Epstein; Epstein Drangel Bazerman & James, LLP

(57) **CLAIM**

The ornamental design for an electric razor, substantially as shown and described.

**DESCRIPTION**

FIG. 1 is an isometric view showing the front, top and one side of our invention;

FIG. 2 is a top plan view of our invention;

FIG. 3 is a bottom plan view of our invention;

FIG. 4 is a front elevation view of our invention;

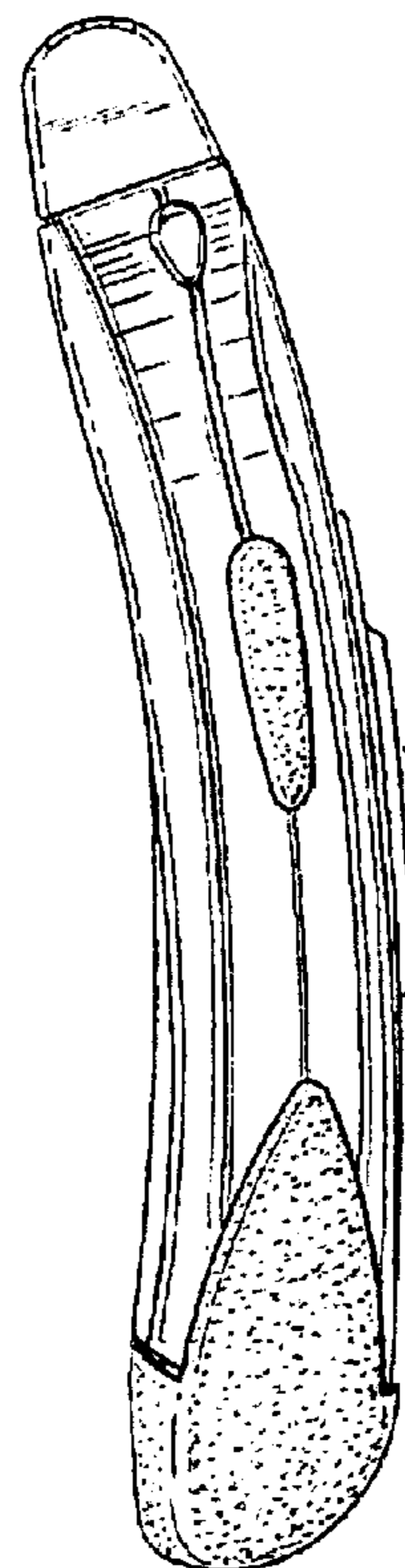
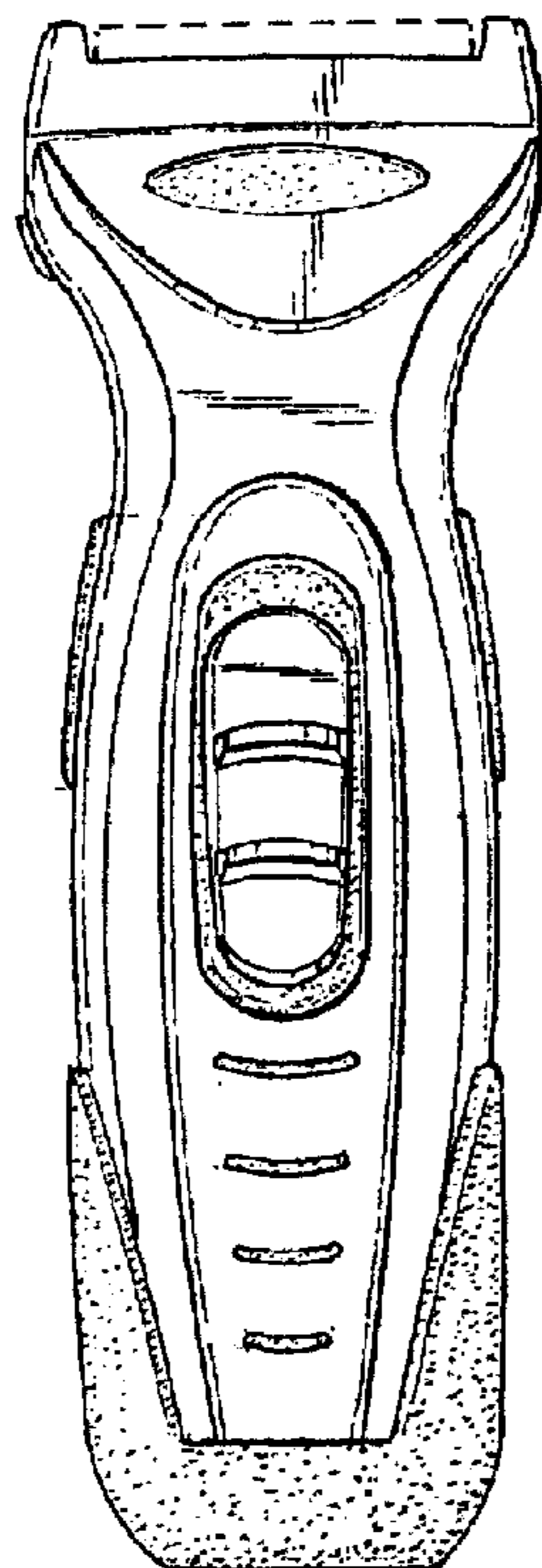
FIG. 5 is a rear elevation view of our invention;

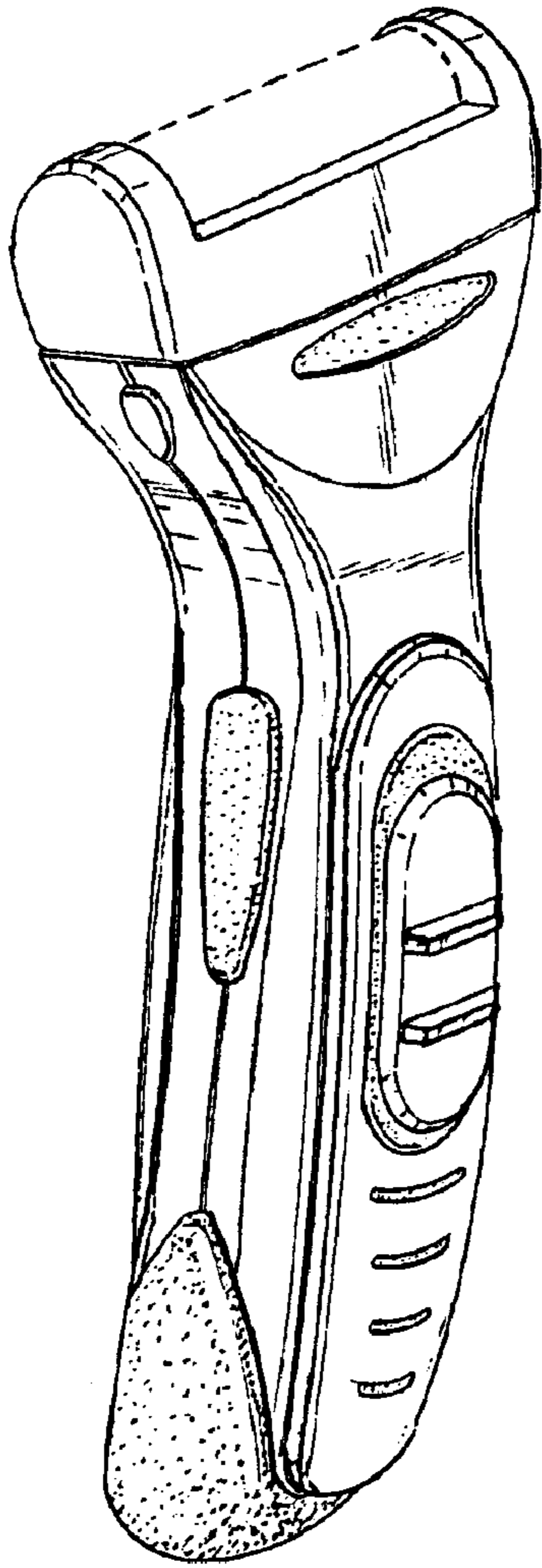
FIG. 6 is an elevation view showing one side of the electric razor of our invention; and,

FIG. 7 is an elevation view of the other side of the electric razor of our invention.

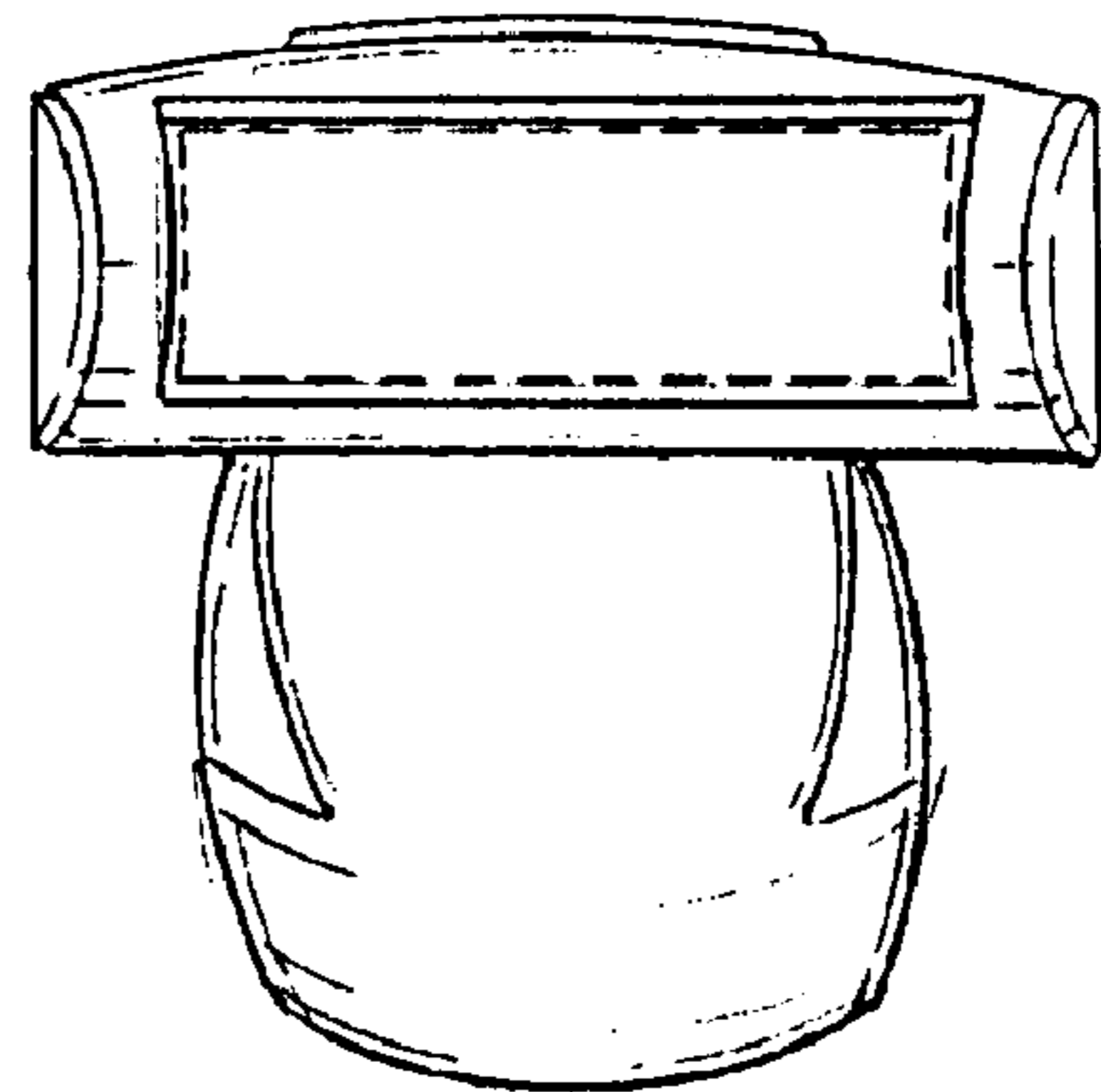
The broken lines are shown for illustrative purposes only and form no part of the claimed design.

**1 Claim, 3 Drawing Sheets**

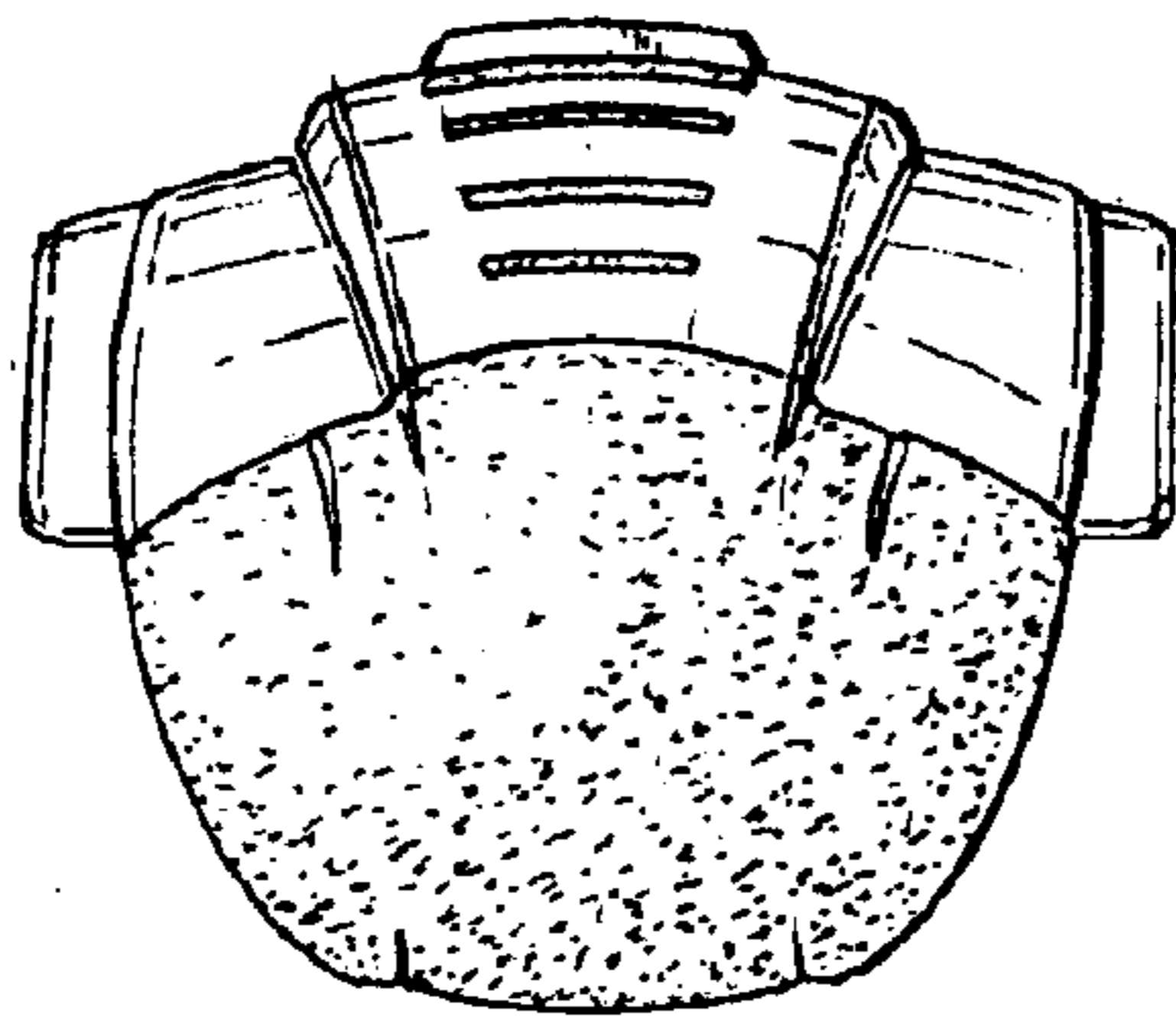




**FIG. 1**

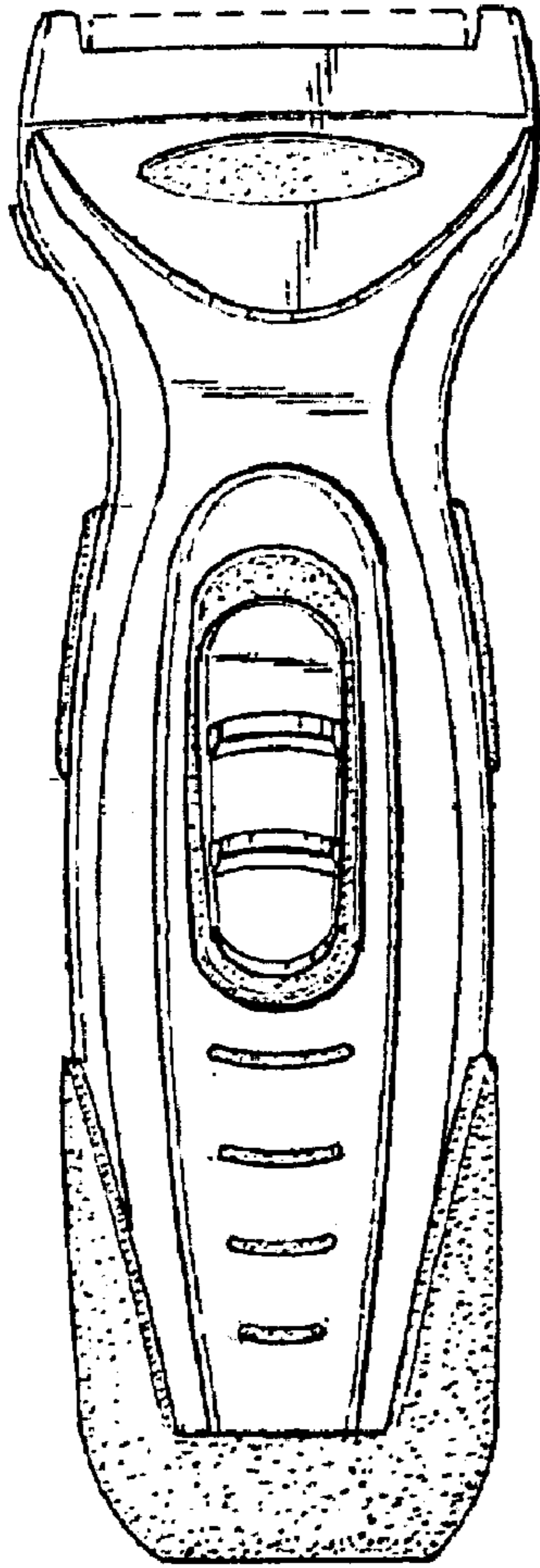


**FIG. 2**

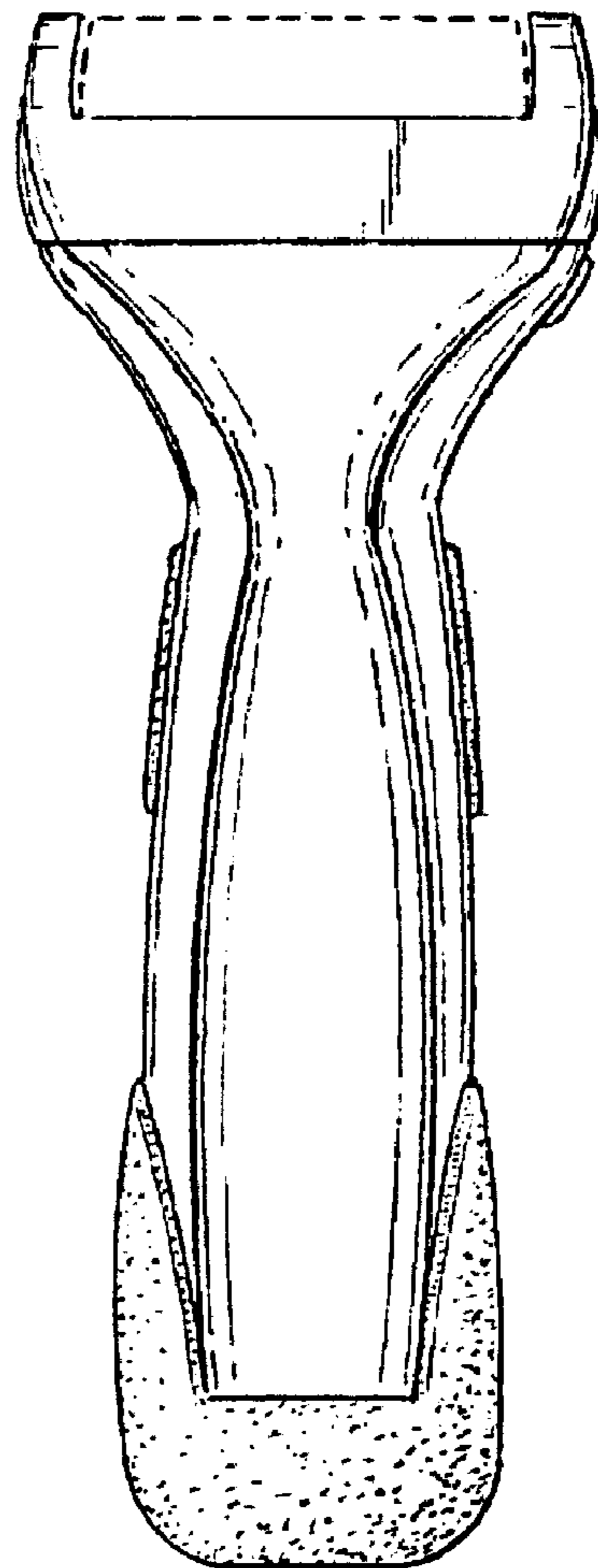


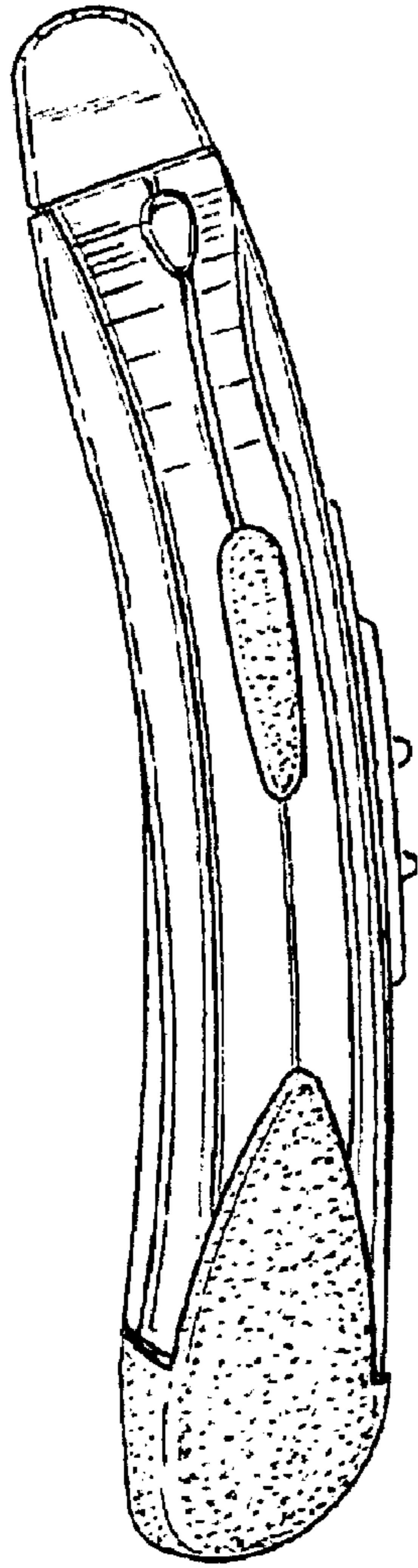
**FIG. 3**

**FIG. 4**

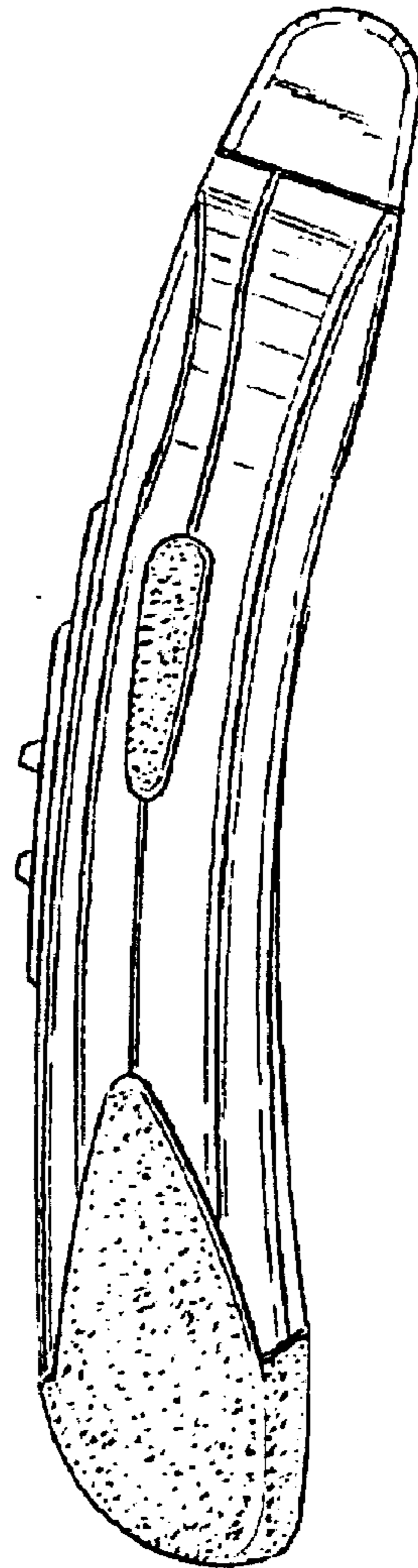


**FIG. 5**





**FIG. 6**



**FIG. 7**