



US00D512433S

(12) **United States Design Patent** (10) **Patent No.:** **US D512,433 S**
Korpai (45) **Date of Patent:** **** *Dec. 6, 2005**

(54) **SCREEN BORDER**

(76) Inventor: **James Korpai**, 67-23 50th Ave., Woodside, NY (US) 11377

(*) Notice: This patent is subject to a terminal disclaimer.

(**) Term: **14 Years**

(21) Appl. No.: **29/181,509**

(22) Filed: **May 12, 2003**

(51) **LOC (8) Cl.** **14-02**

(52) **U.S. Cl.** **D14/450**

(58) **Field of Search** D14/441-446, D14/448-450, 126; D13/162, 184, 199; 312/223.2; 361/690-696; 40/725; 248/442.2

(56) **References Cited**

U.S. PATENT DOCUMENTS

5,549,267	A	*	8/1996	Armbruster et al.	248/442.2
5,901,937	A		5/1999	Compeau et al.		
D437,695	S		2/2001	Leung		
D453,504	S	*	2/2002	Bong et al.	D14/126
D461,113	S		8/2002	Aubert Capella		
D473,877	S	*	4/2003	Korpai	D14/448
6,543,167	B1	*	4/2003	Dwyer	40/725
6,550,172	B2	*	4/2003	Korpai	40/725

* cited by examiner

Primary Examiner—Freda S. Nunn

(57) **CLAIM**

The ornamental design for a screen border, as shown and described.

DESCRIPTION

FIG. 1 is a front view of a screen border showing my new design being attached to a monitor that is shown in dotted

lines for environment and forms no part of the claimed invention;

FIG. 2 is a rear view thereof;
 FIG. 3 is a perspective view thereof;
 FIG. 4 is a top view thereof;
 FIG. 5 is a bottom view thereof;
 FIG. 6 is a left end view thereof;
 FIG. 7 is a right end view thereof;
 FIG. 8 is a front view showing a second embodiment of my new design;
 FIG. 9 is a rear view thereof;
 FIG. 10 is a perspective view thereof;
 FIG. 11 is a top view thereof;
 FIG. 12 is a bottom view thereof;
 FIG. 13 is a right end view thereof;
 FIG. 14 is a left end view thereof;
 FIG. 15 is a front view showing a third embodiment of my new design, wherein the squared cover members are transparent. The rear view of this embodiment is represented by FIG. 2;
 FIG. 16 is a perspective view thereof;
 FIG. 17 is a top view thereof;
 FIG. 18 is a bottom view thereof;
 FIG. 19 is a left end view thereof;
 FIG. 20 is a right end view thereof;
 FIG. 21 is a front view showing a fourth embodiment of my new design, wherein the squared cover members are transparent. The rear view of this embodiment is represented by FIG. 9;
 FIG. 22 is a perspective view thereof;
 FIG. 23 is a left end view thereof;
 FIG. 24 is a right end view thereof;
 FIG. 25 is a top view thereof; and
 FIG. 26 is a bottom view thereof.

The squared portions of the border of my new design may be transparent, translucent or opaque.

1 Claim, 18 Drawing Sheets

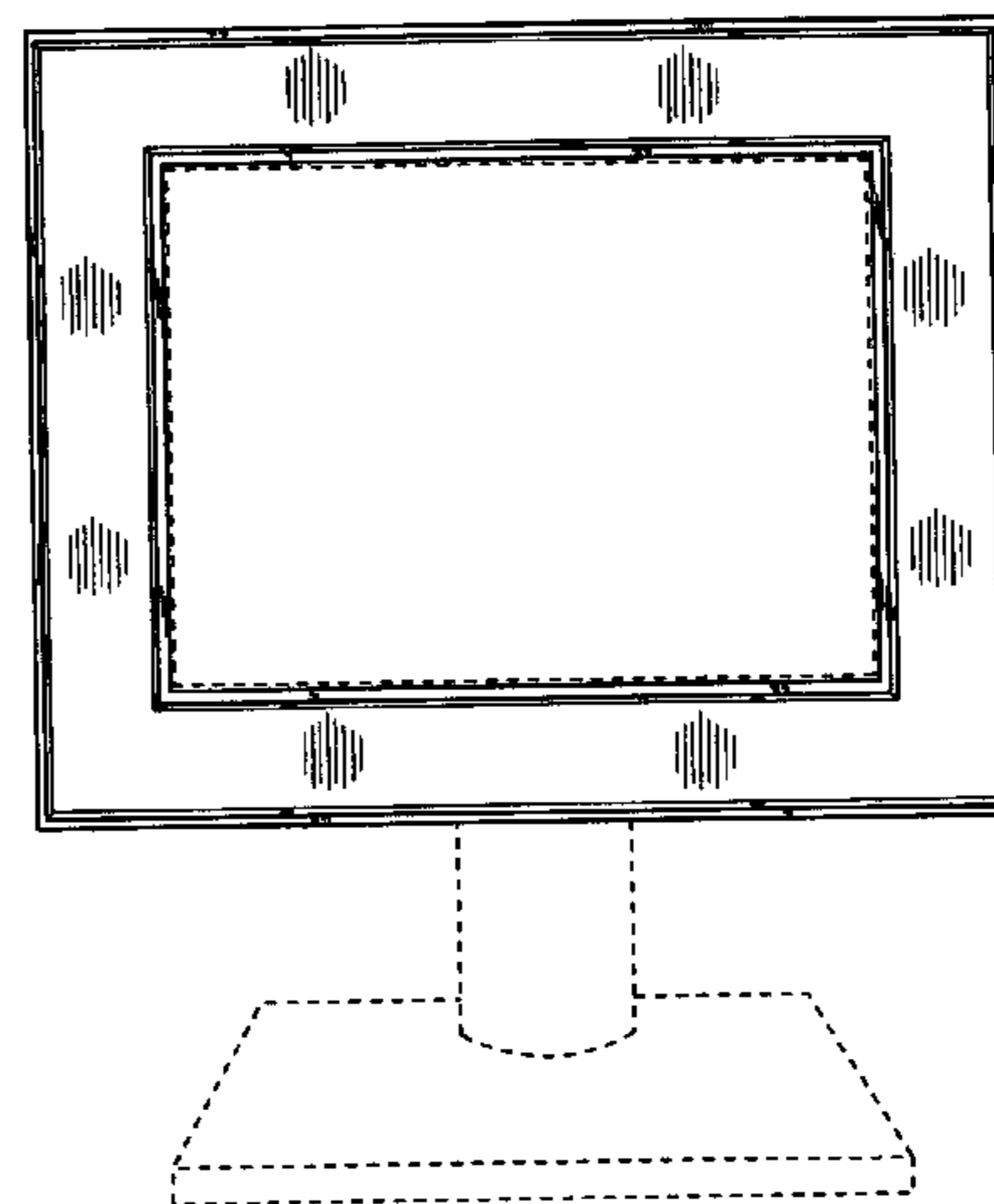
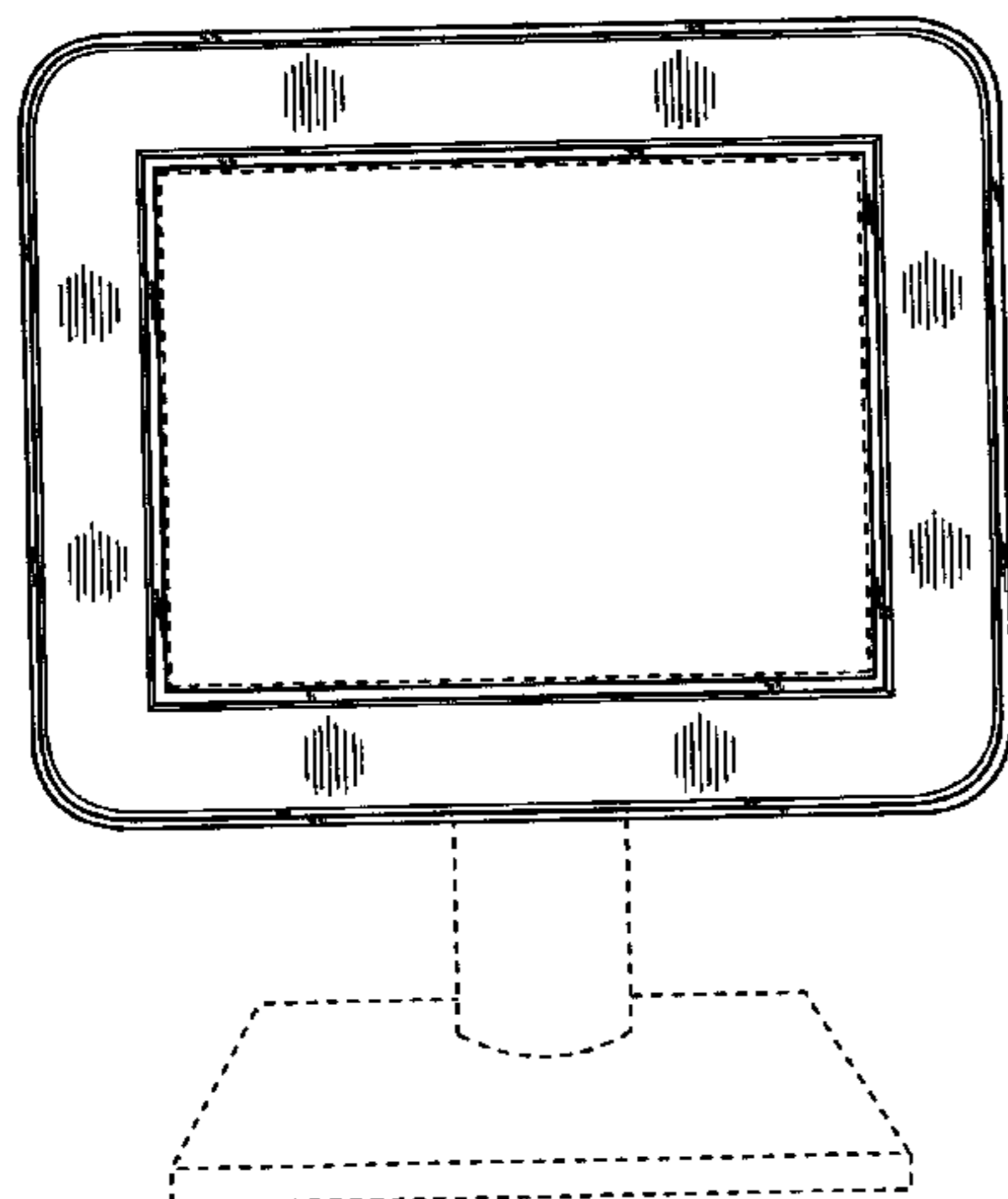

FIG. 1

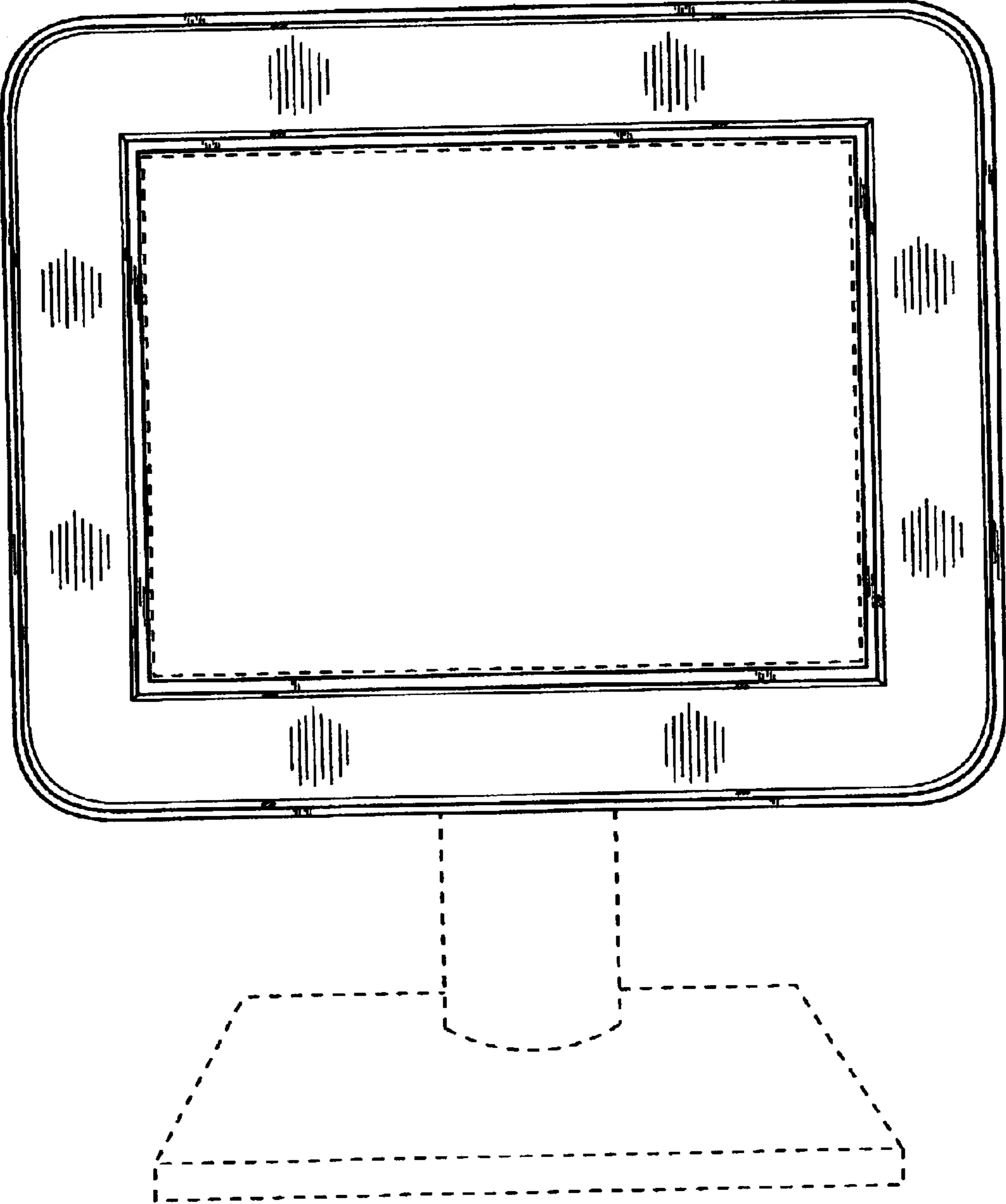

FIG. 2

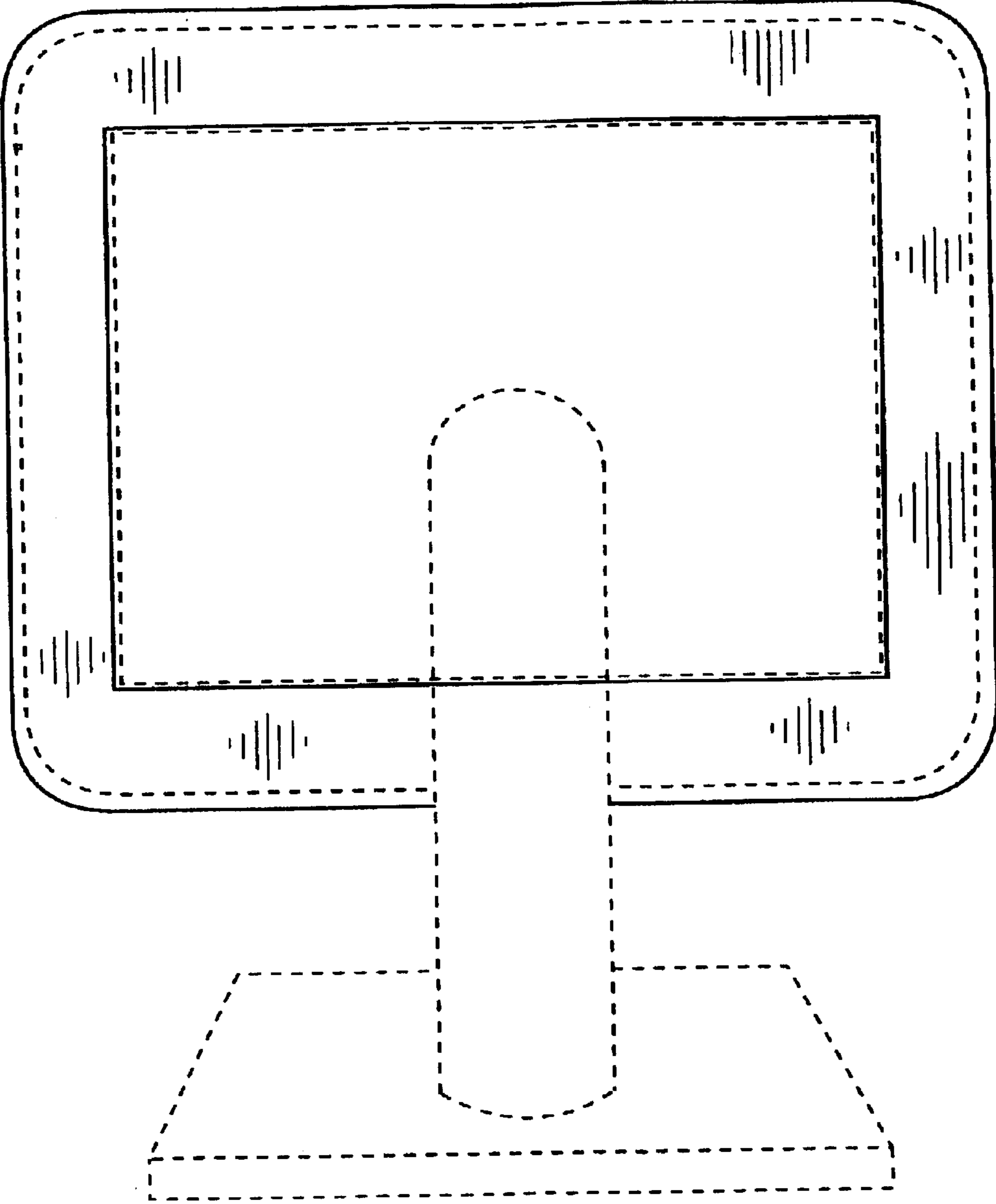

FIG. 3

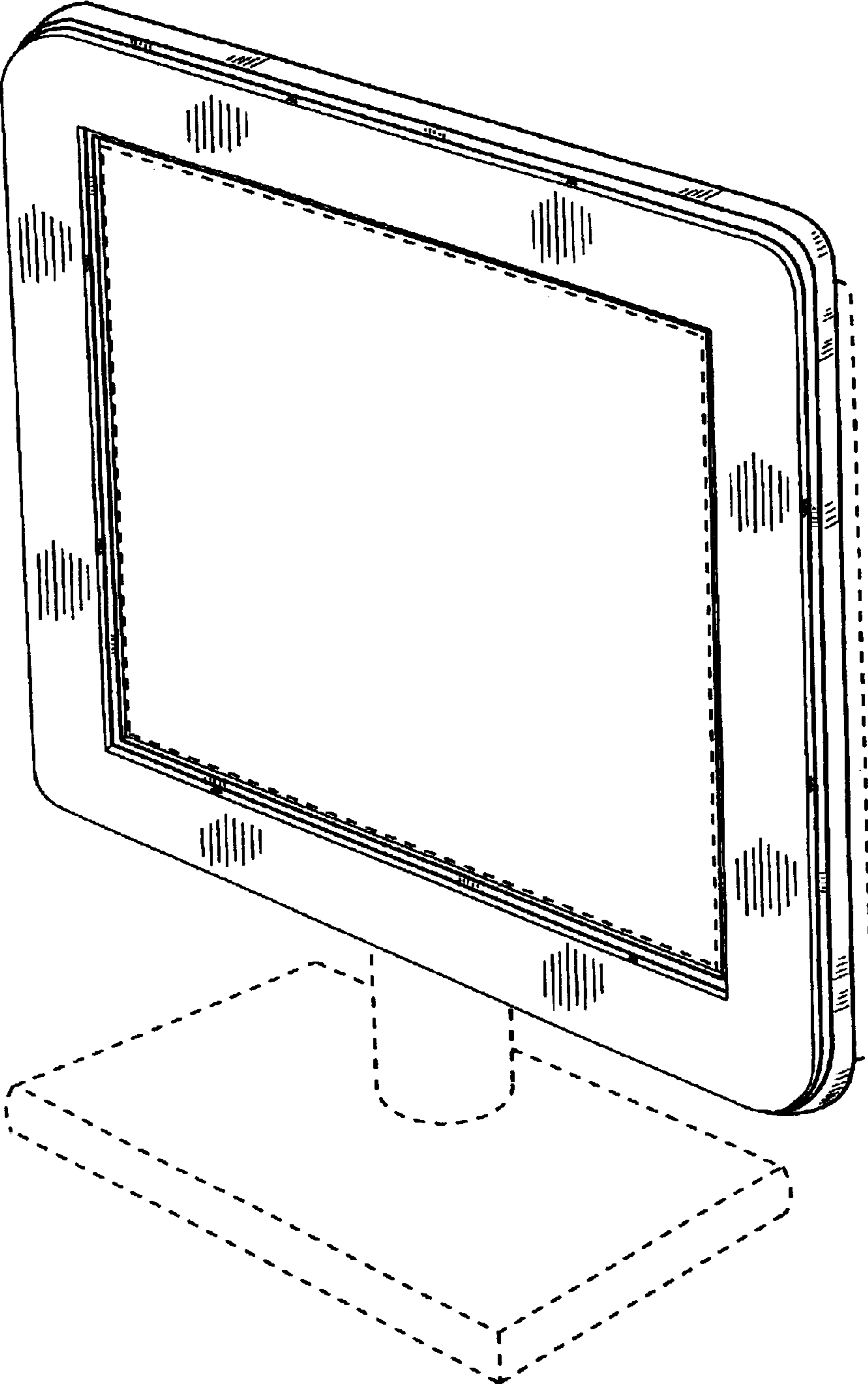

FIG. 4

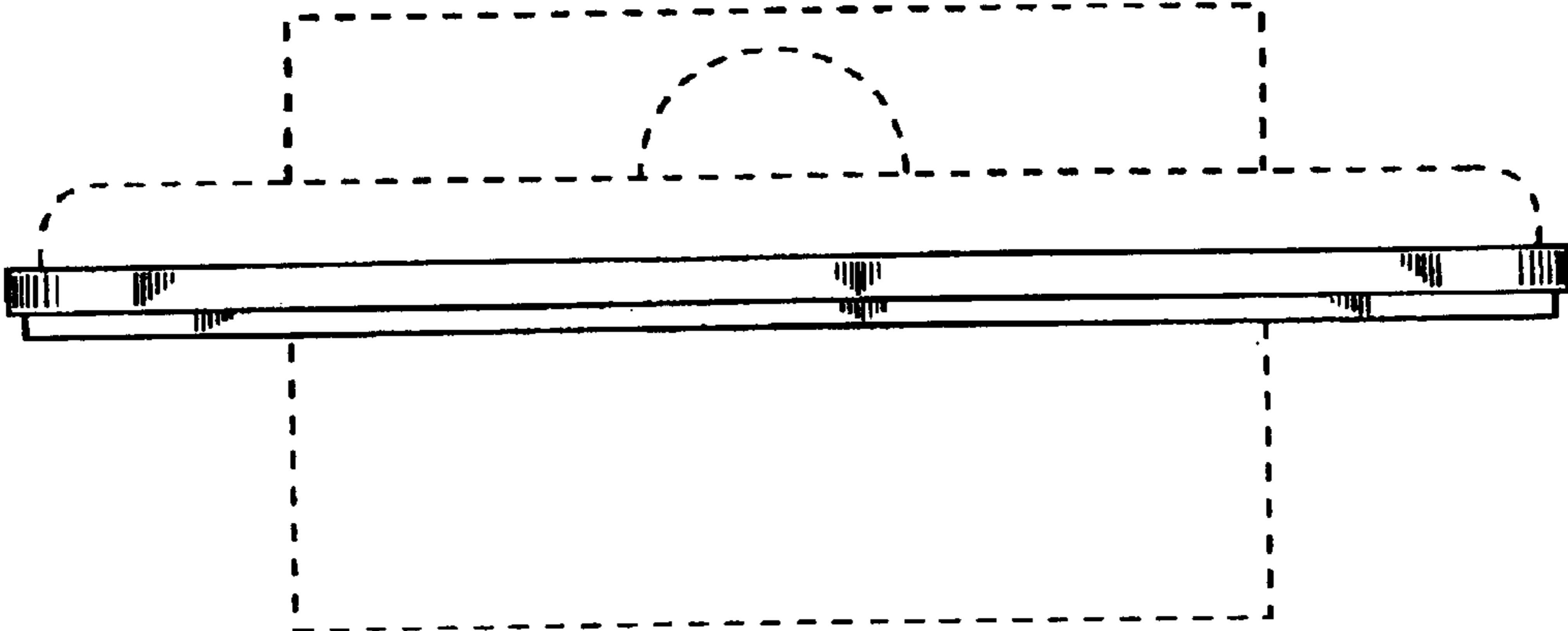

FIG. 5

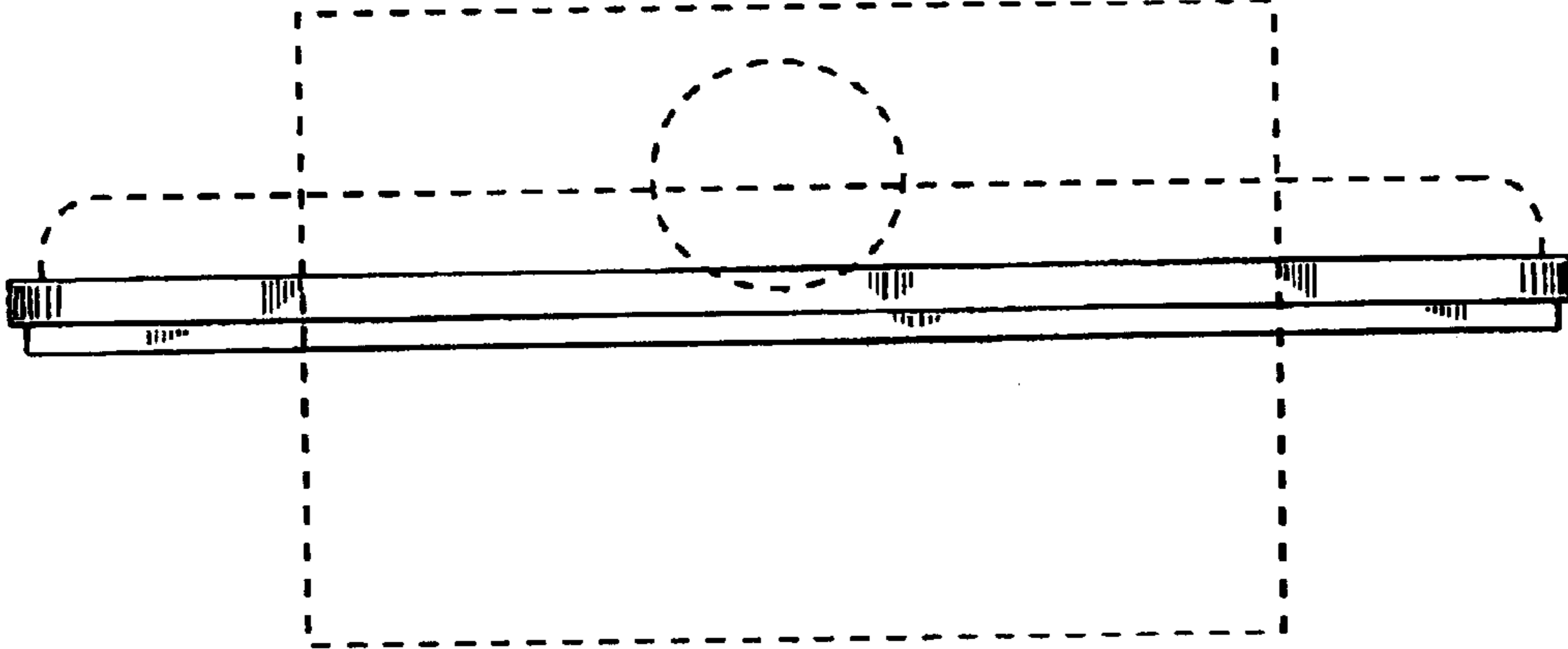

FIG. 6

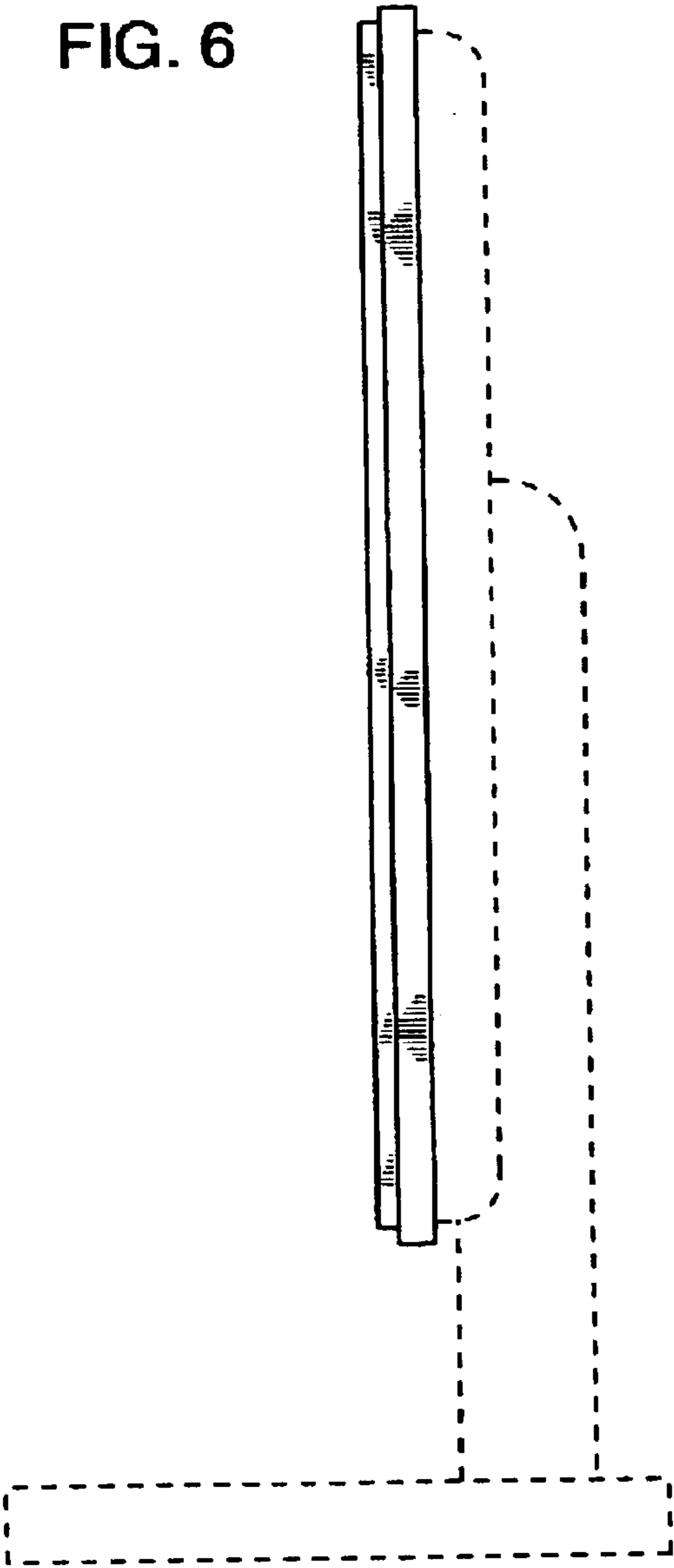

FIG. 7

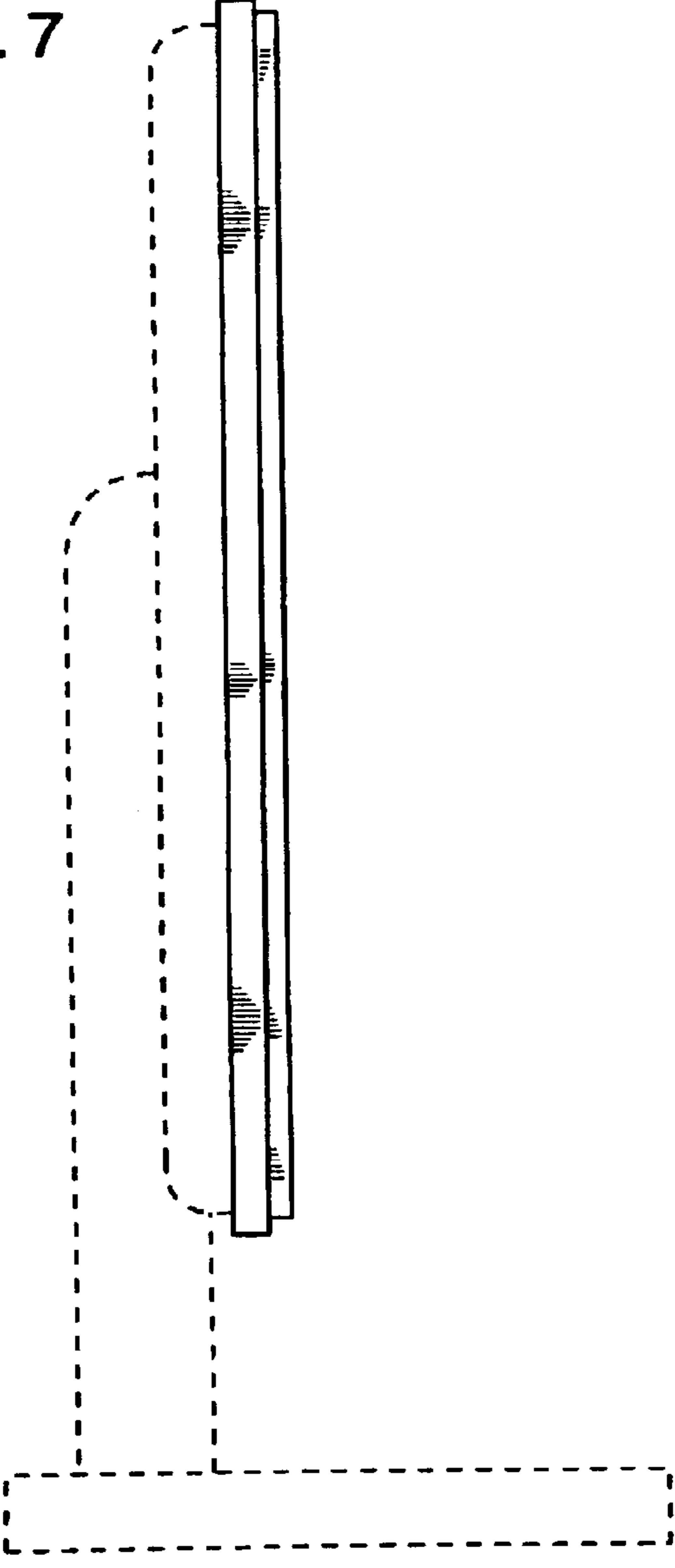

FIG. 8

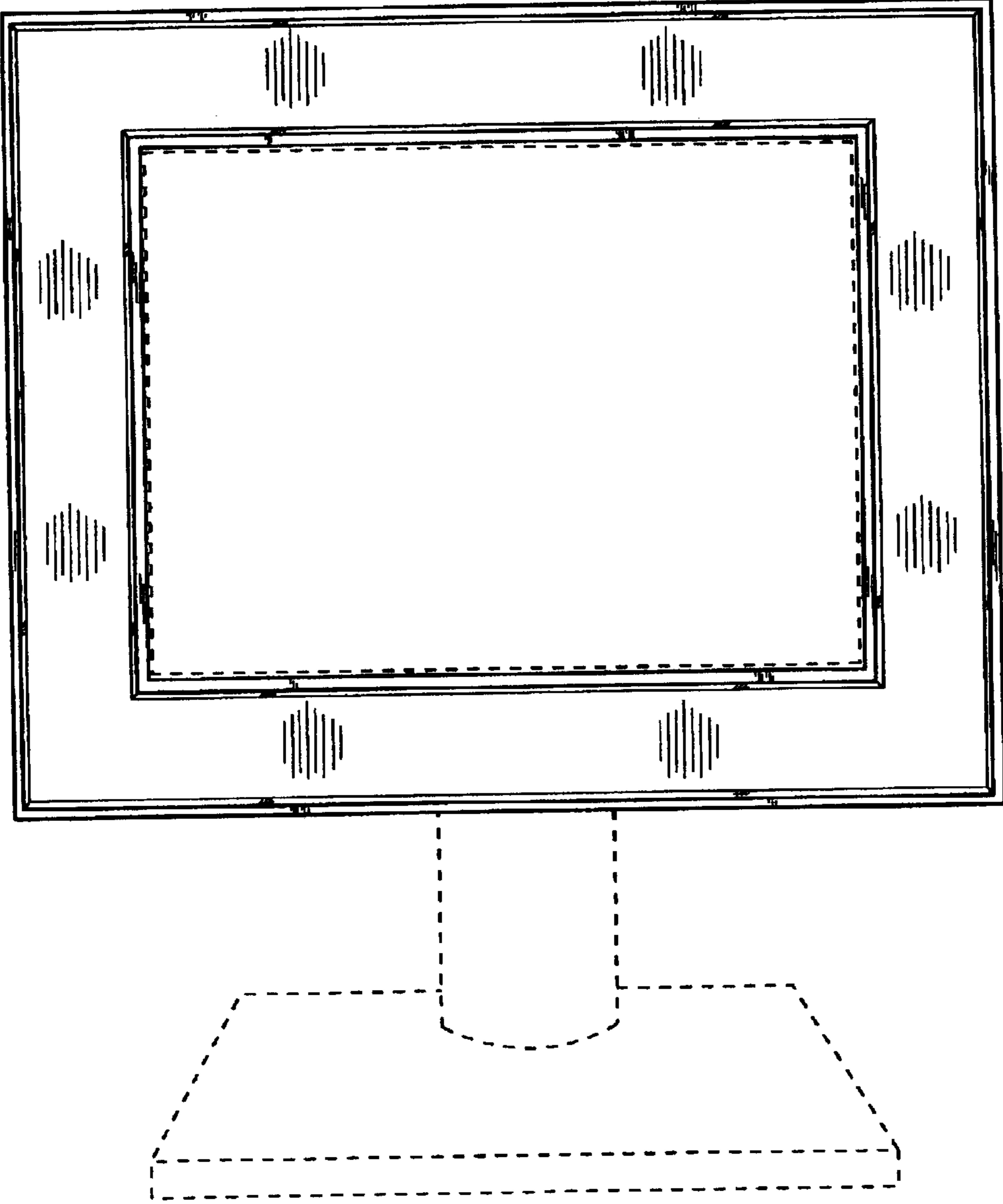

FIG. 9

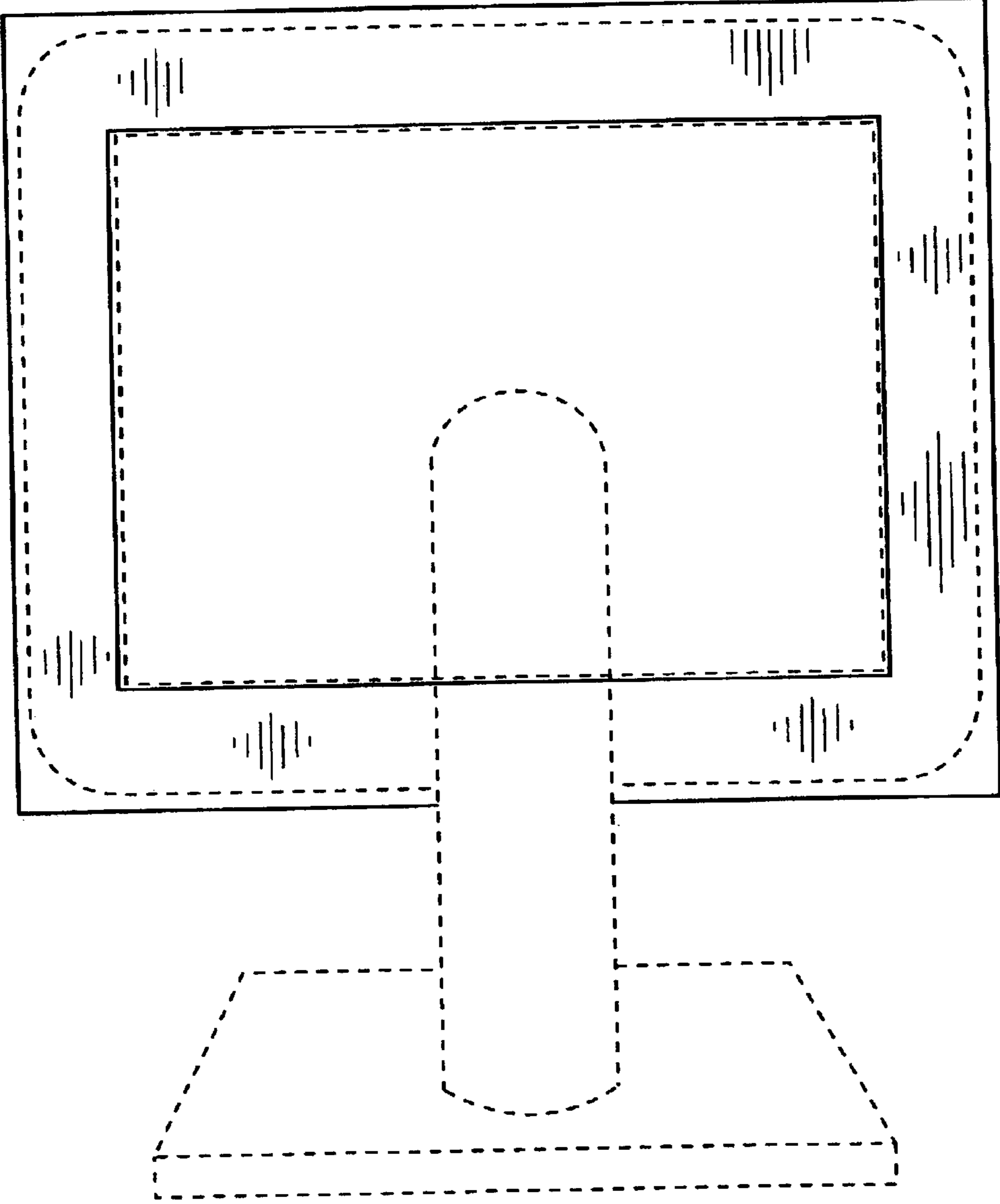

FIG. 10

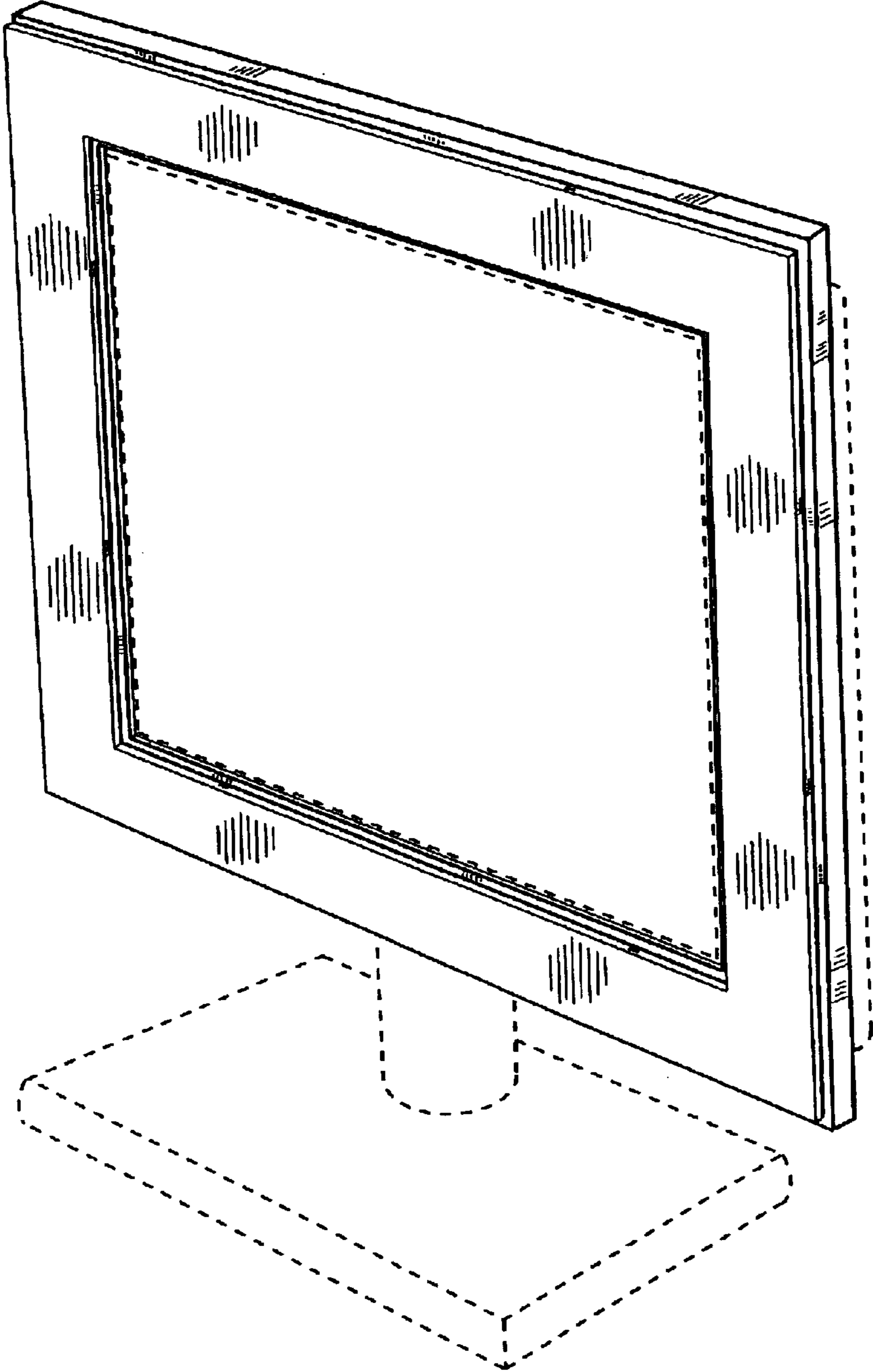

FIG. 11

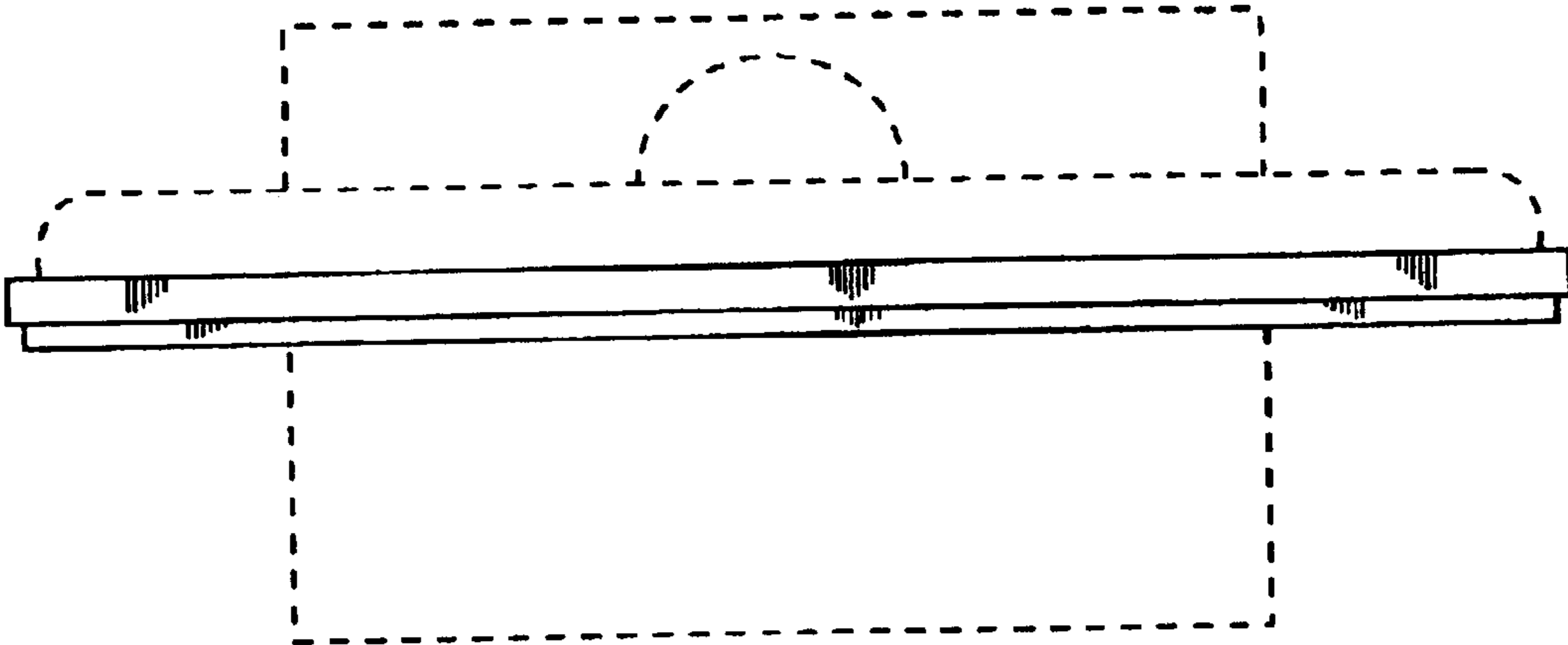

FIG. 12

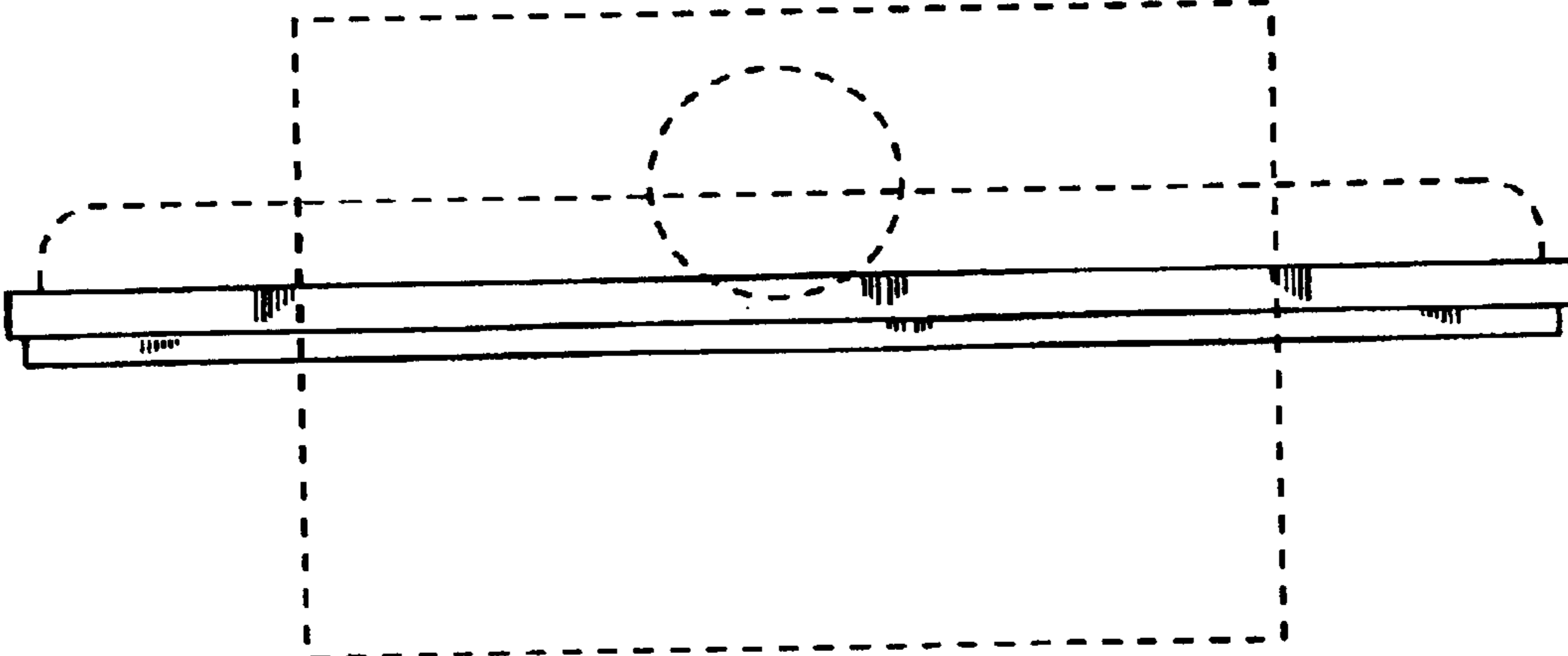

FIG. 13

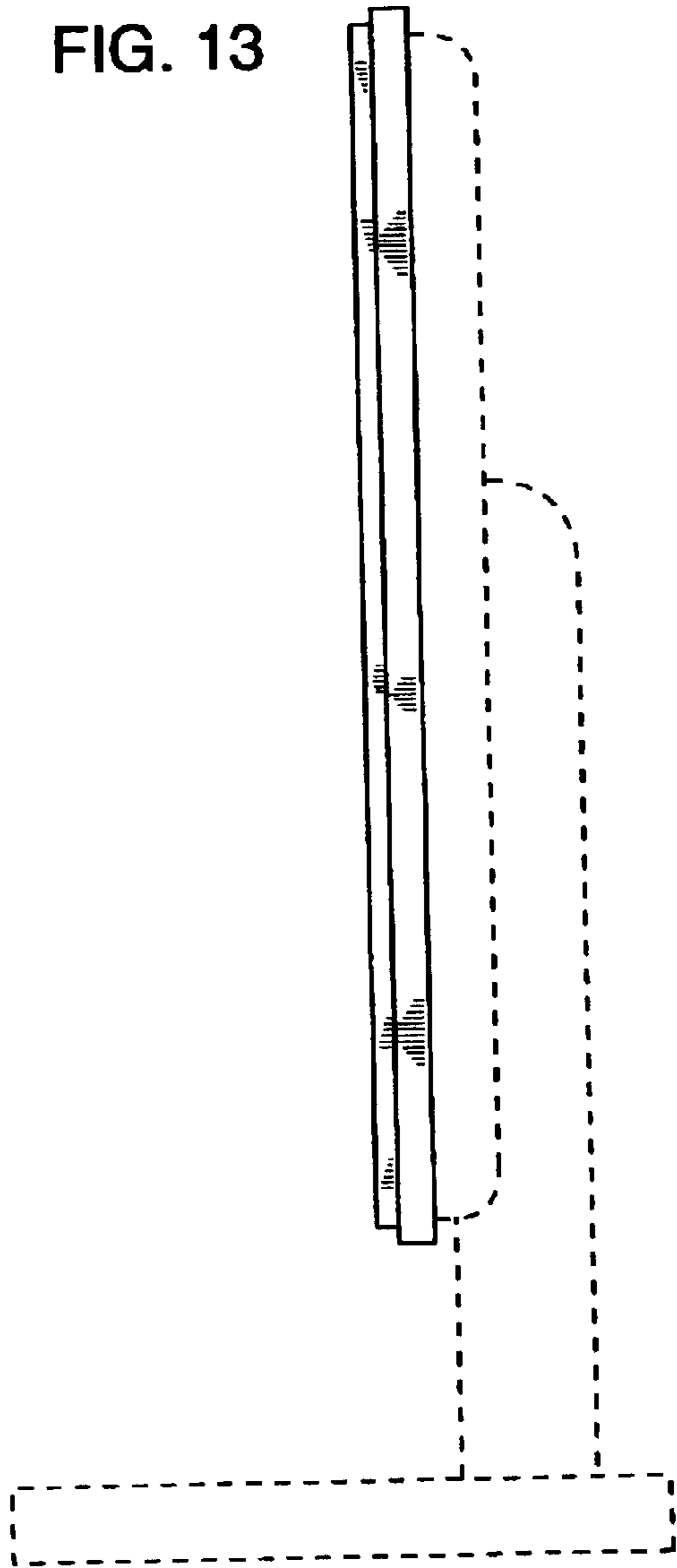

FIG. 14

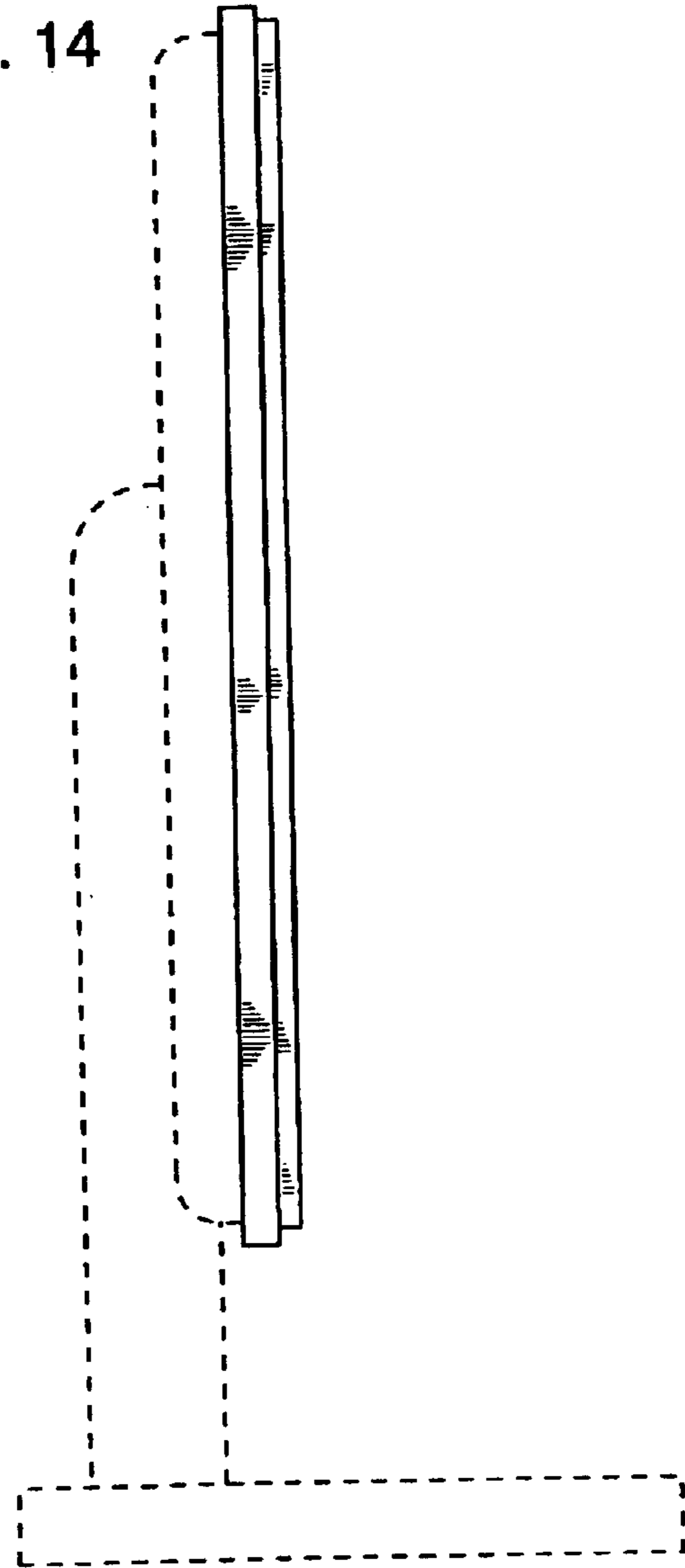

FIG. 15

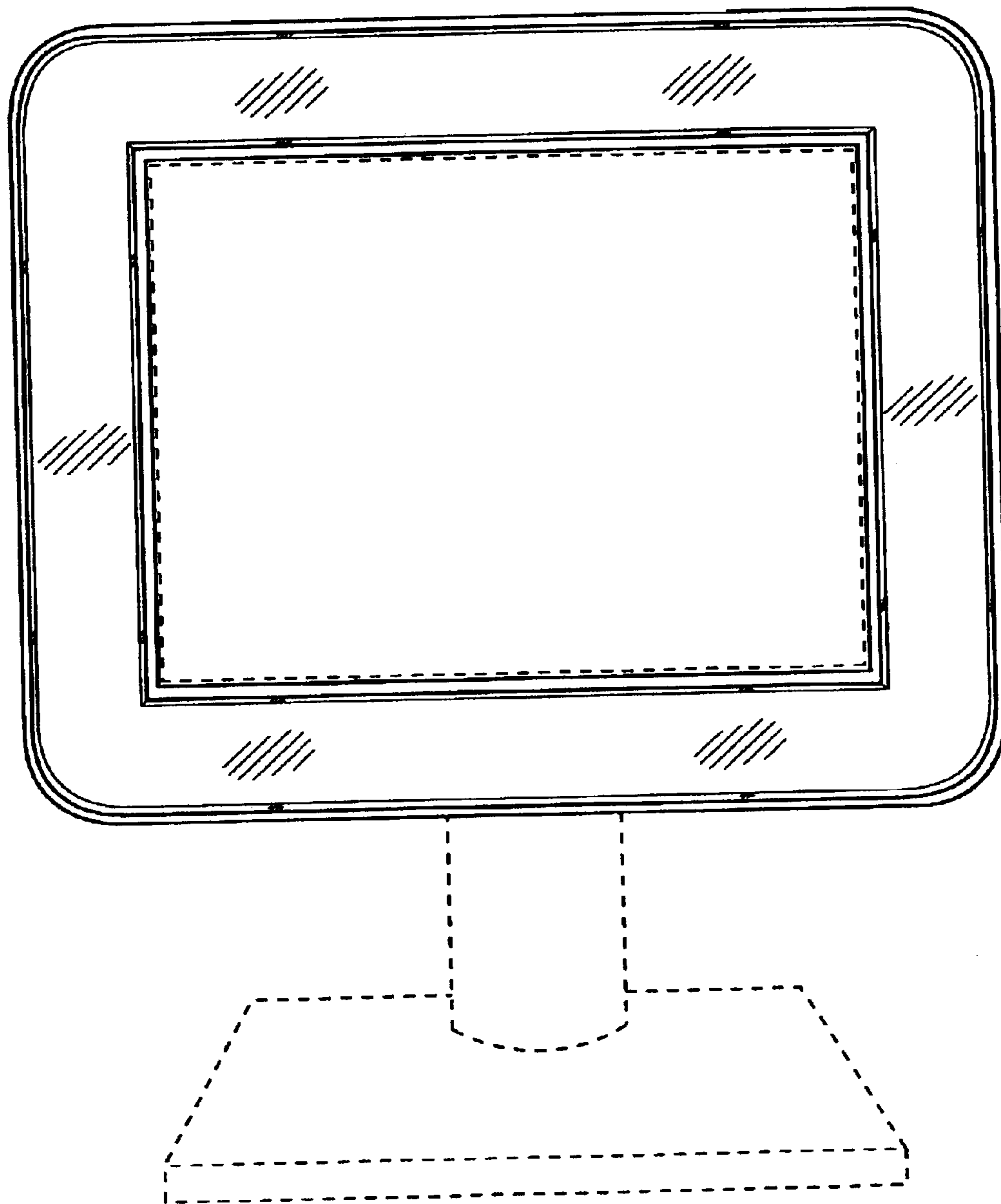

FIG. 16

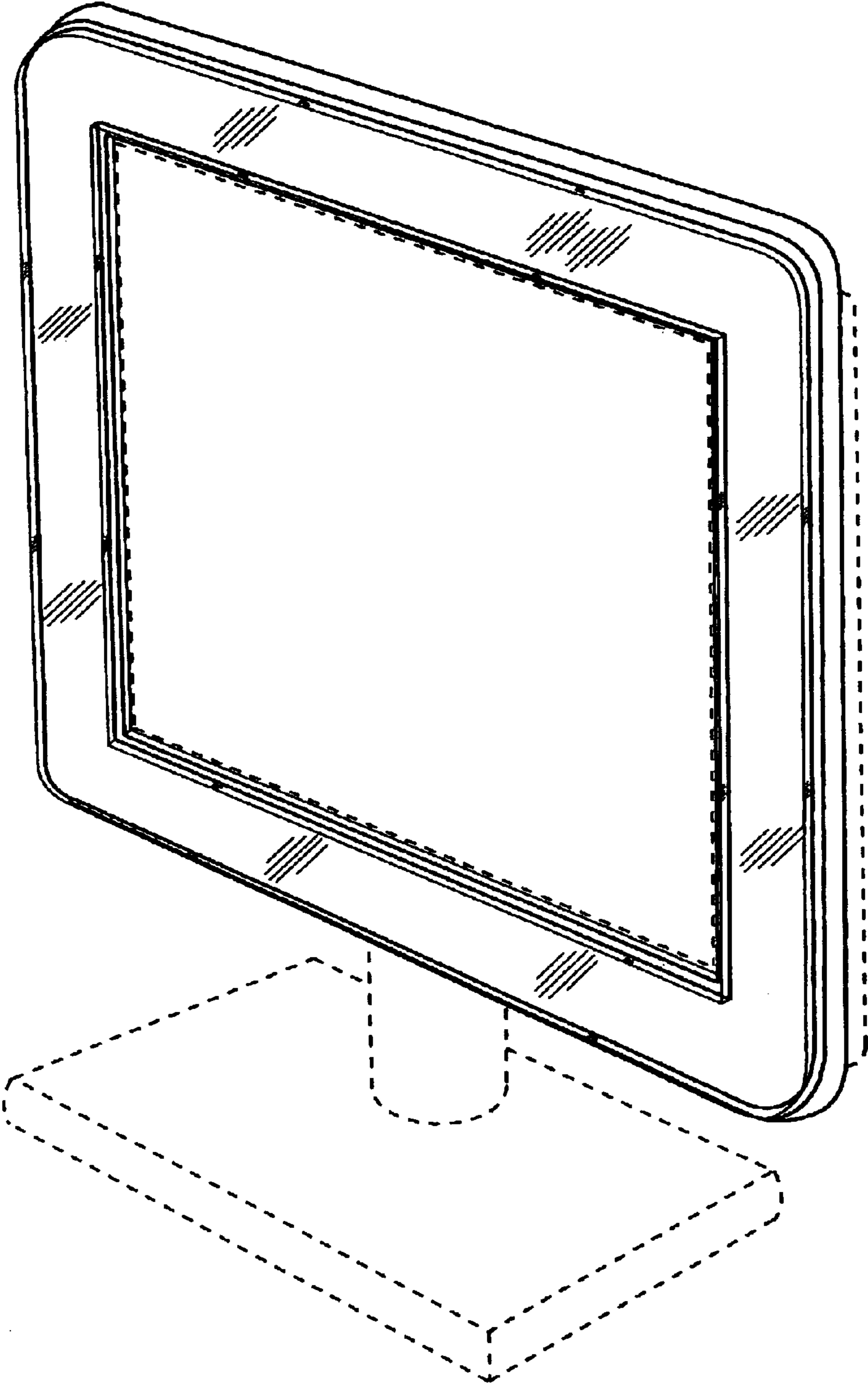

FIG. 17

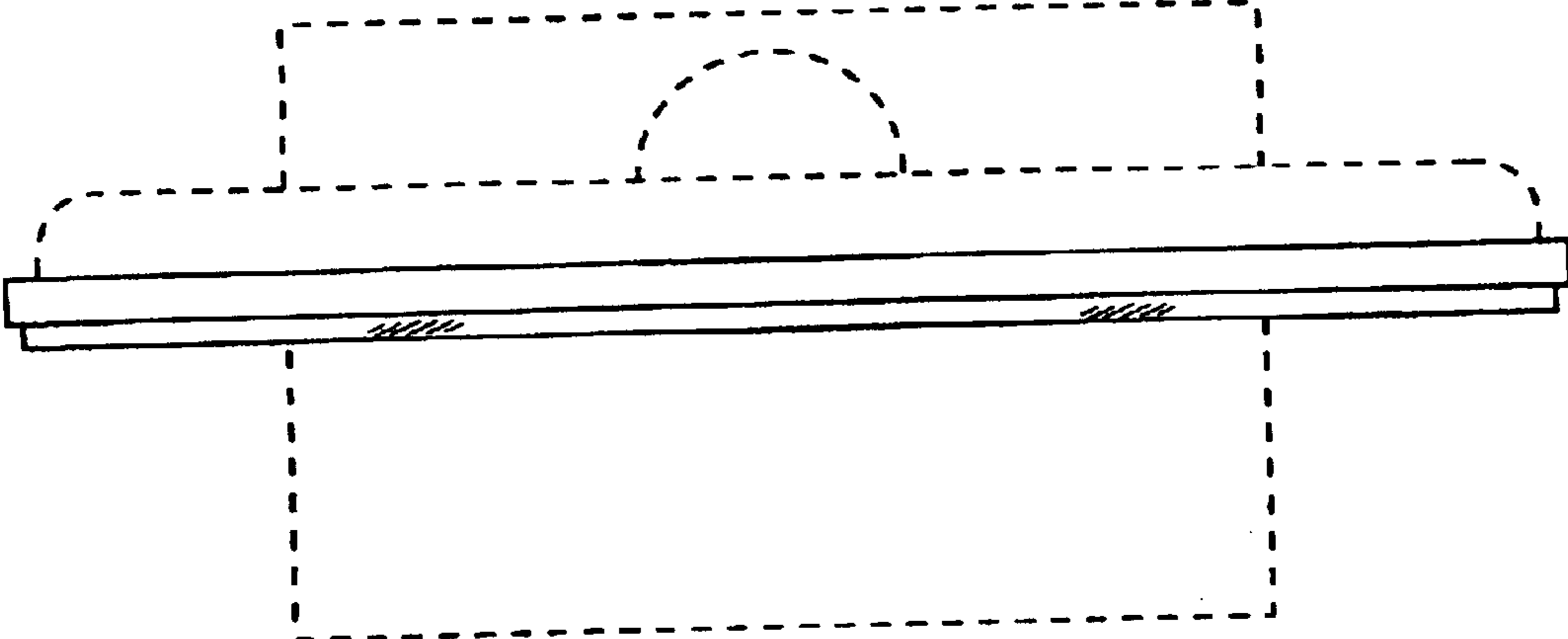

FIG. 18

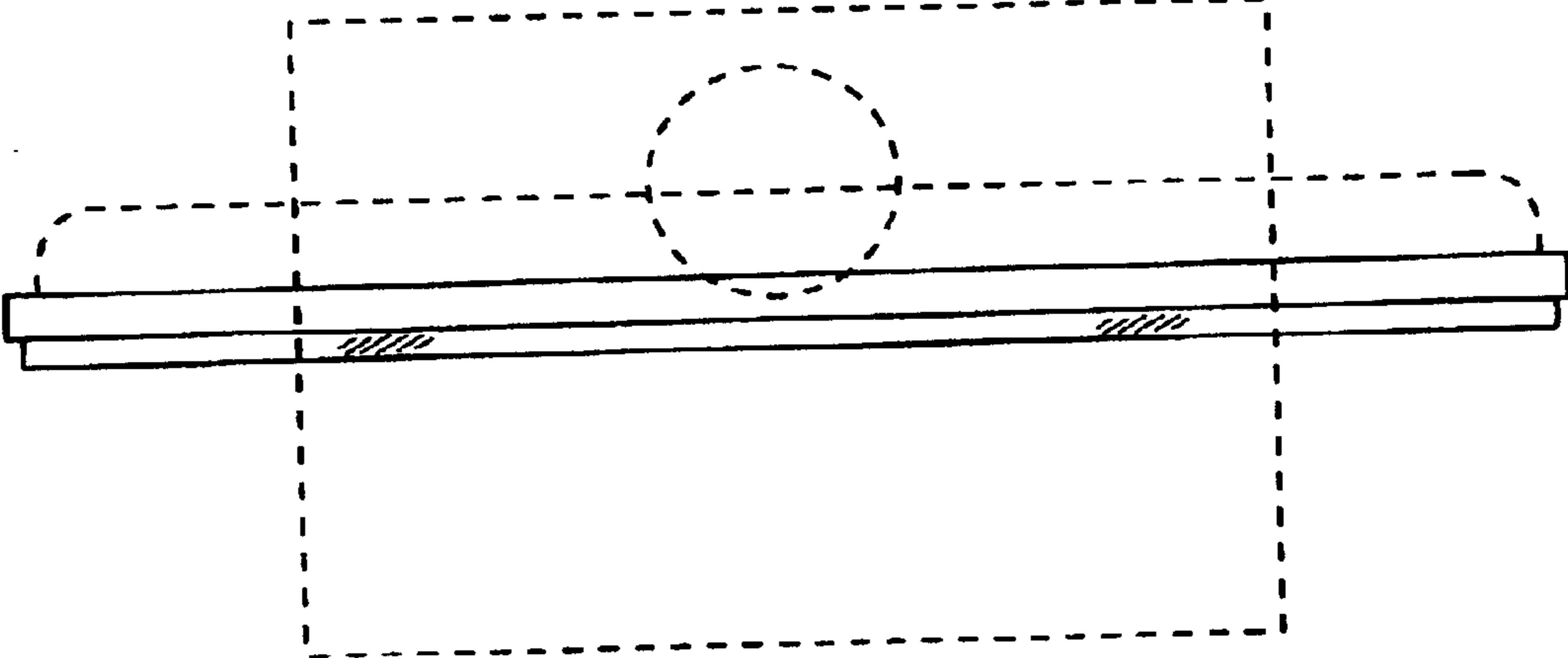

FIG. 19

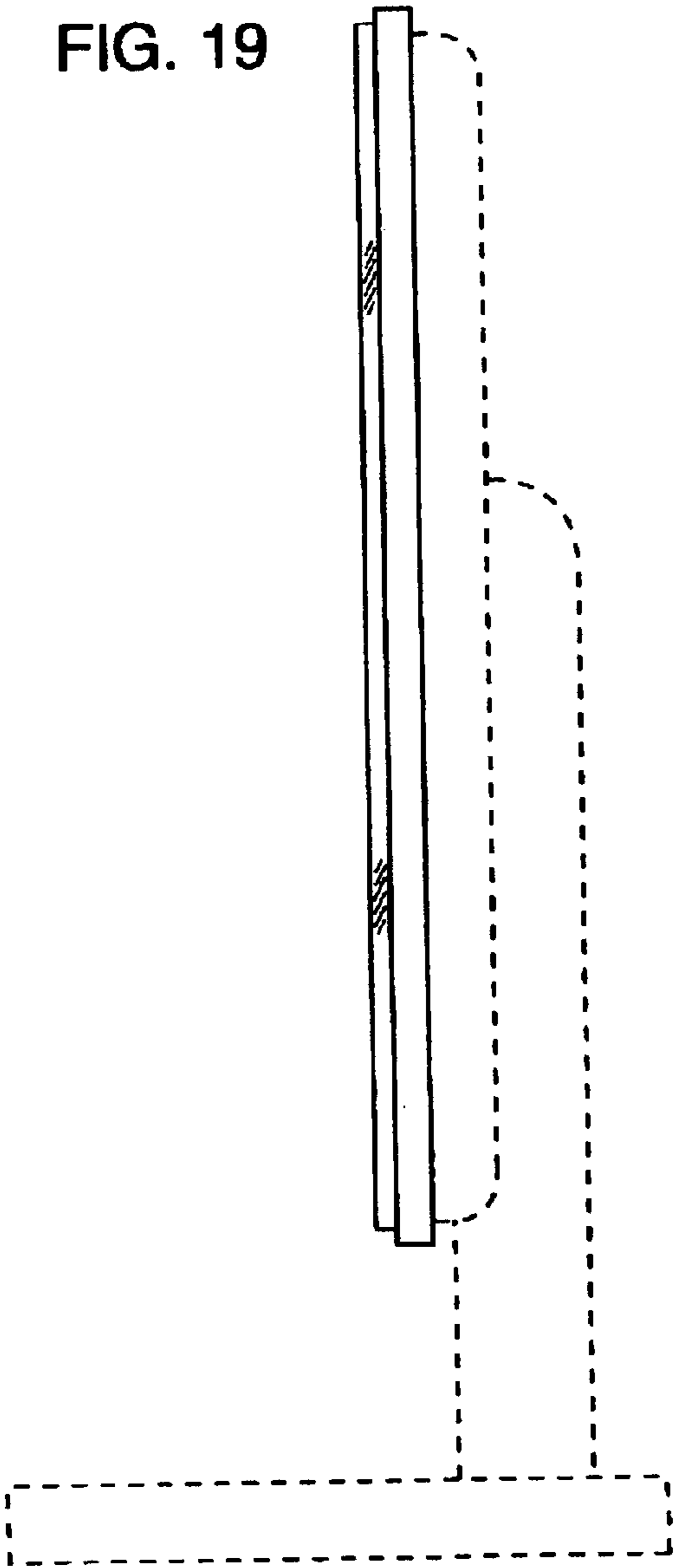

FIG. 20

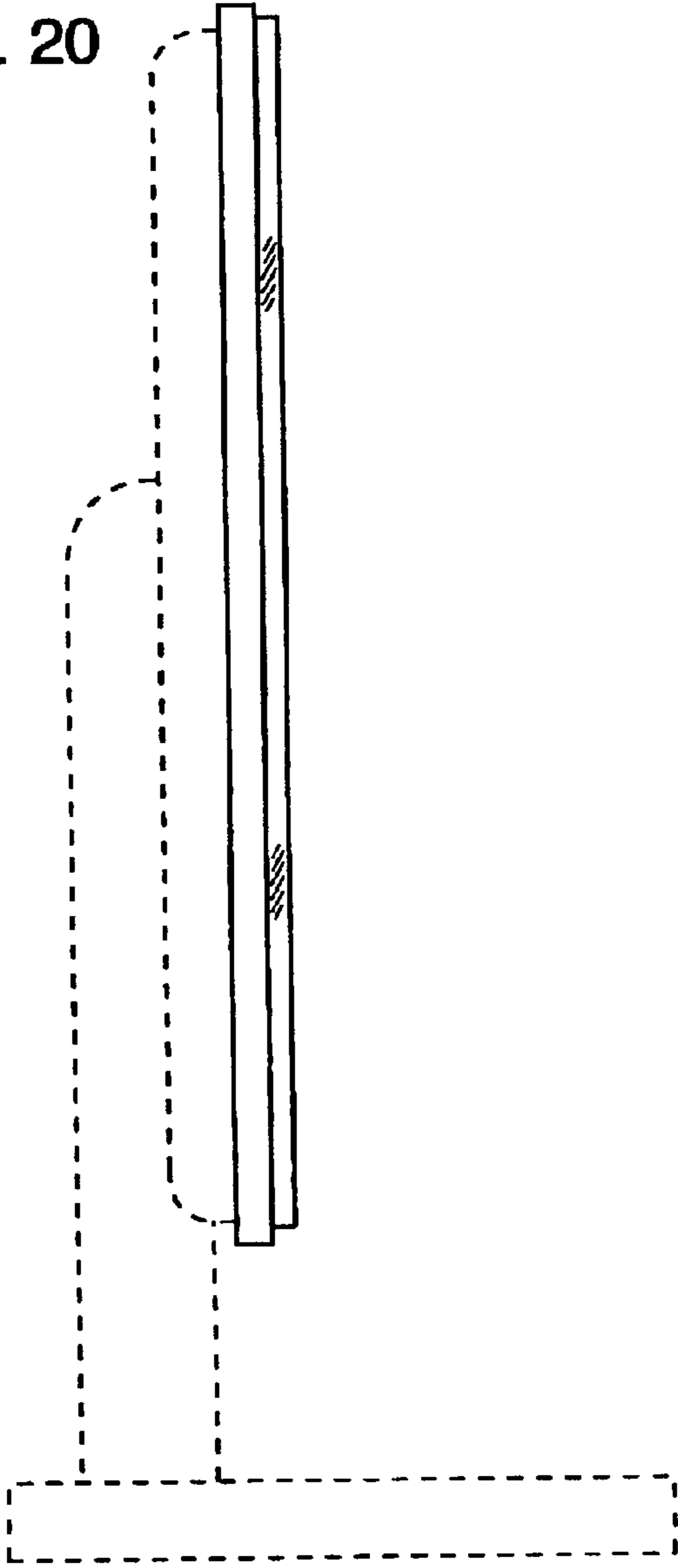

FIG. 21

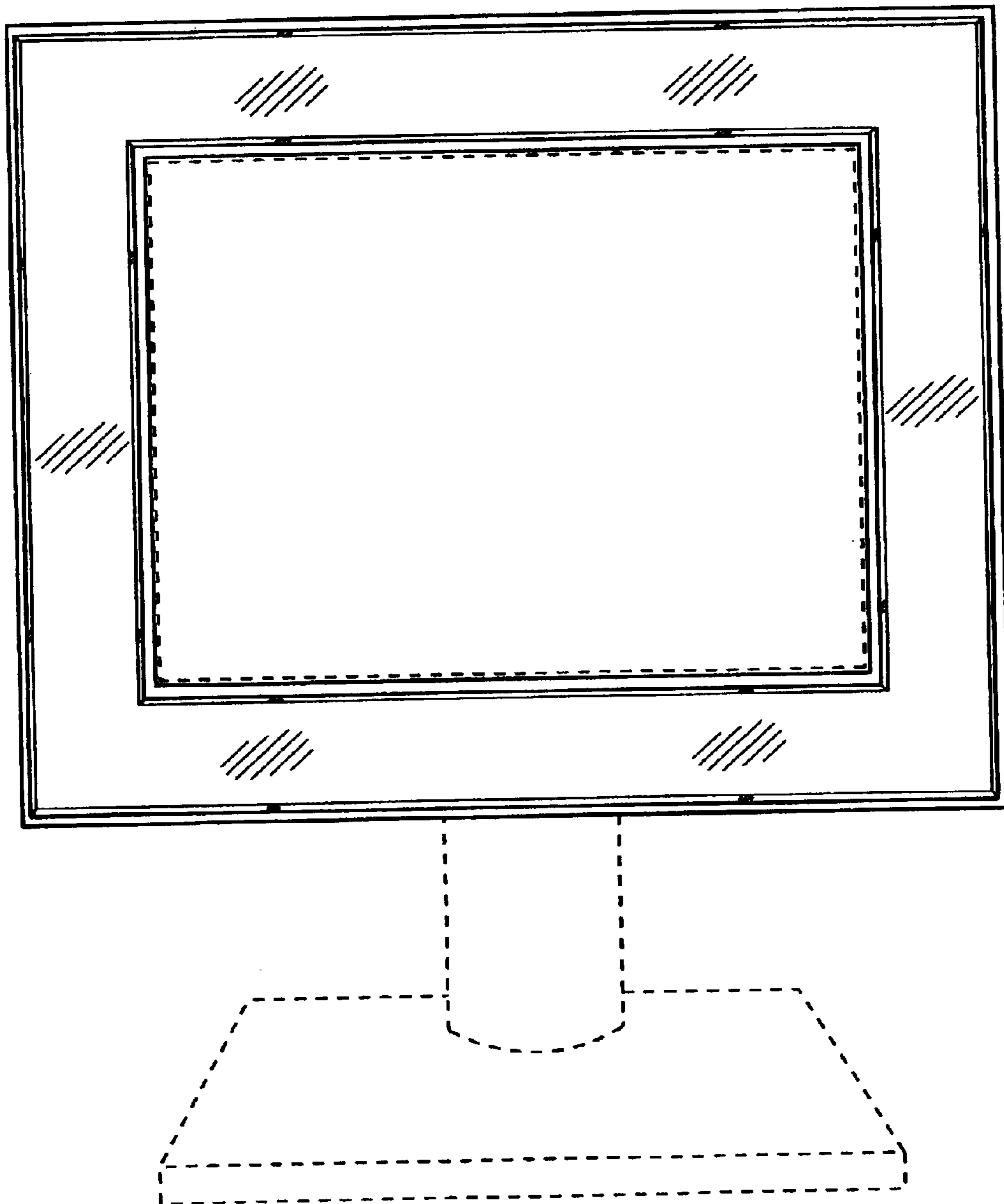

FIG. 22

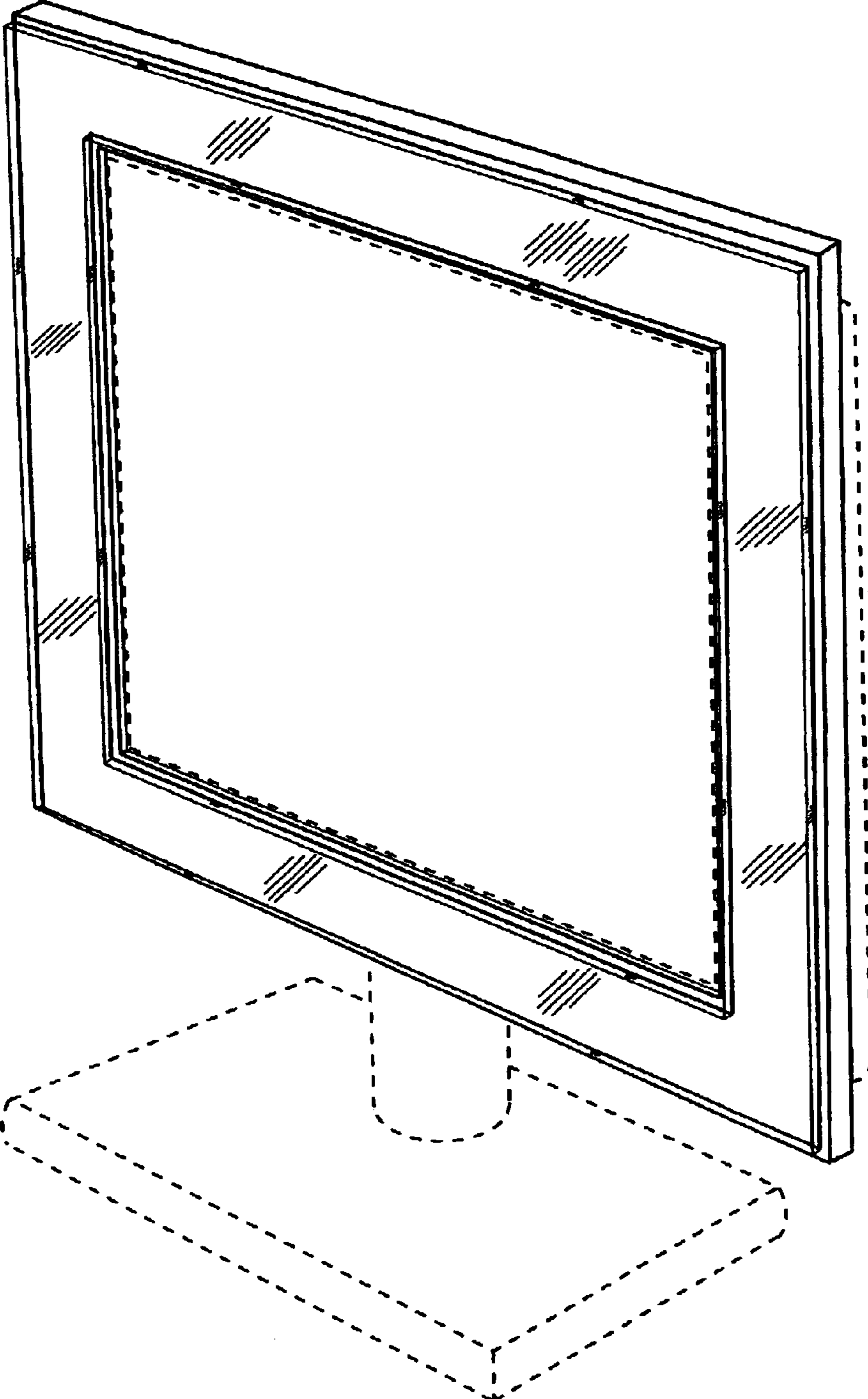

FIG. 23

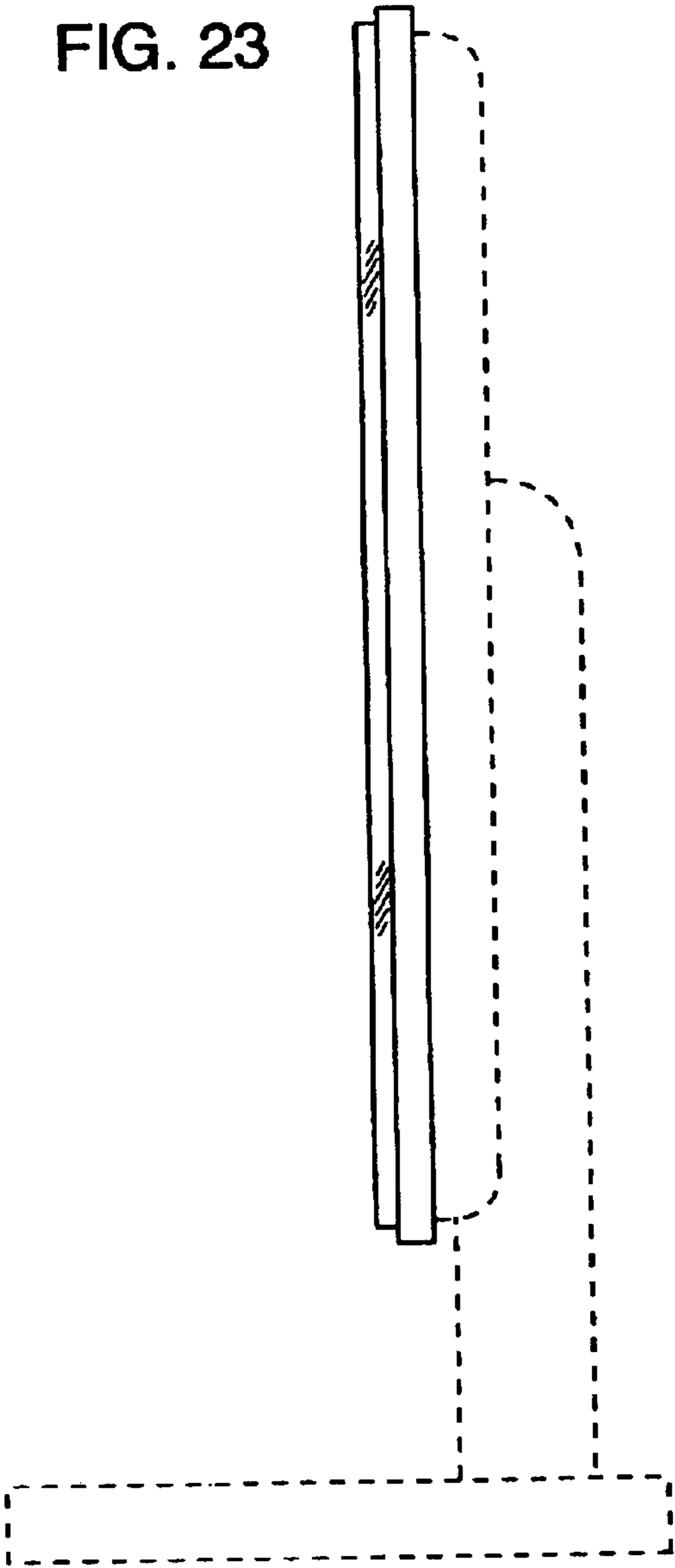

FIG. 24

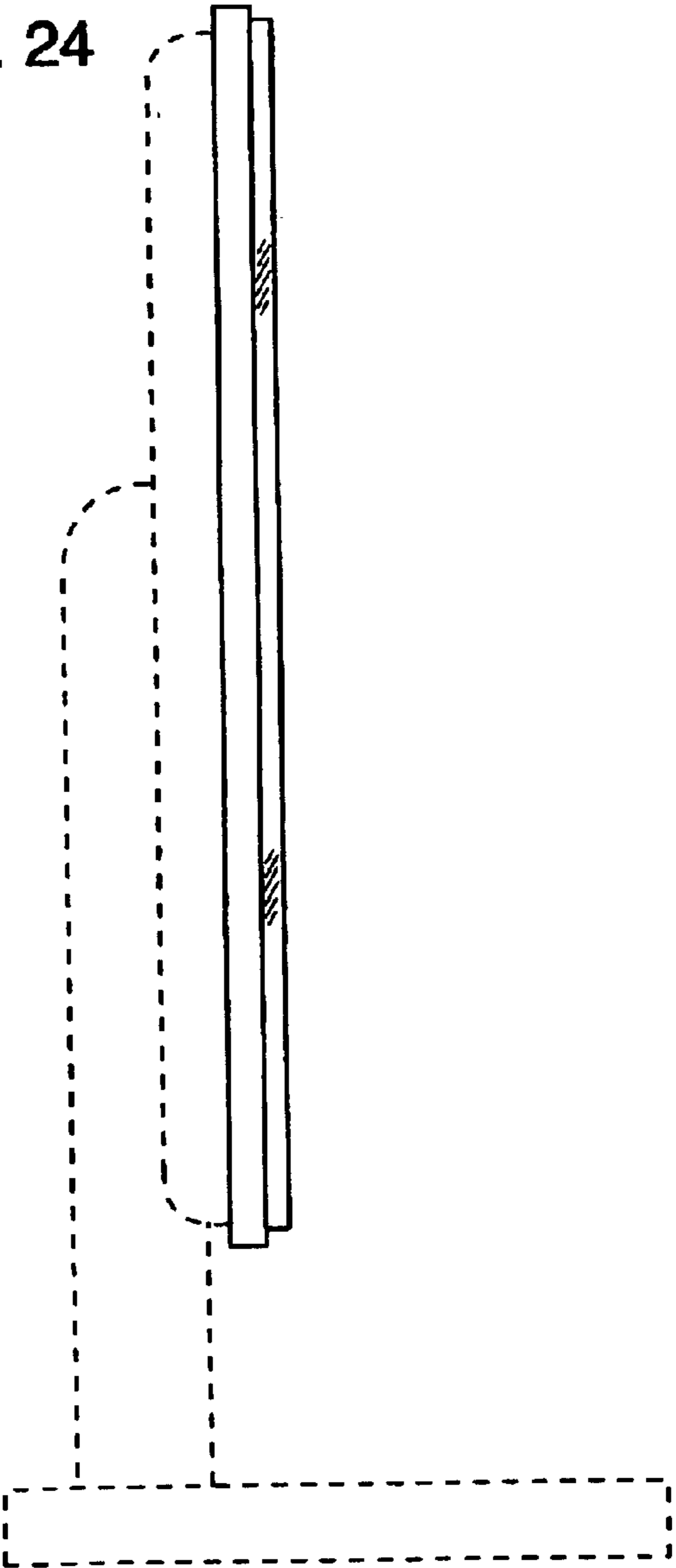

FIG. 25

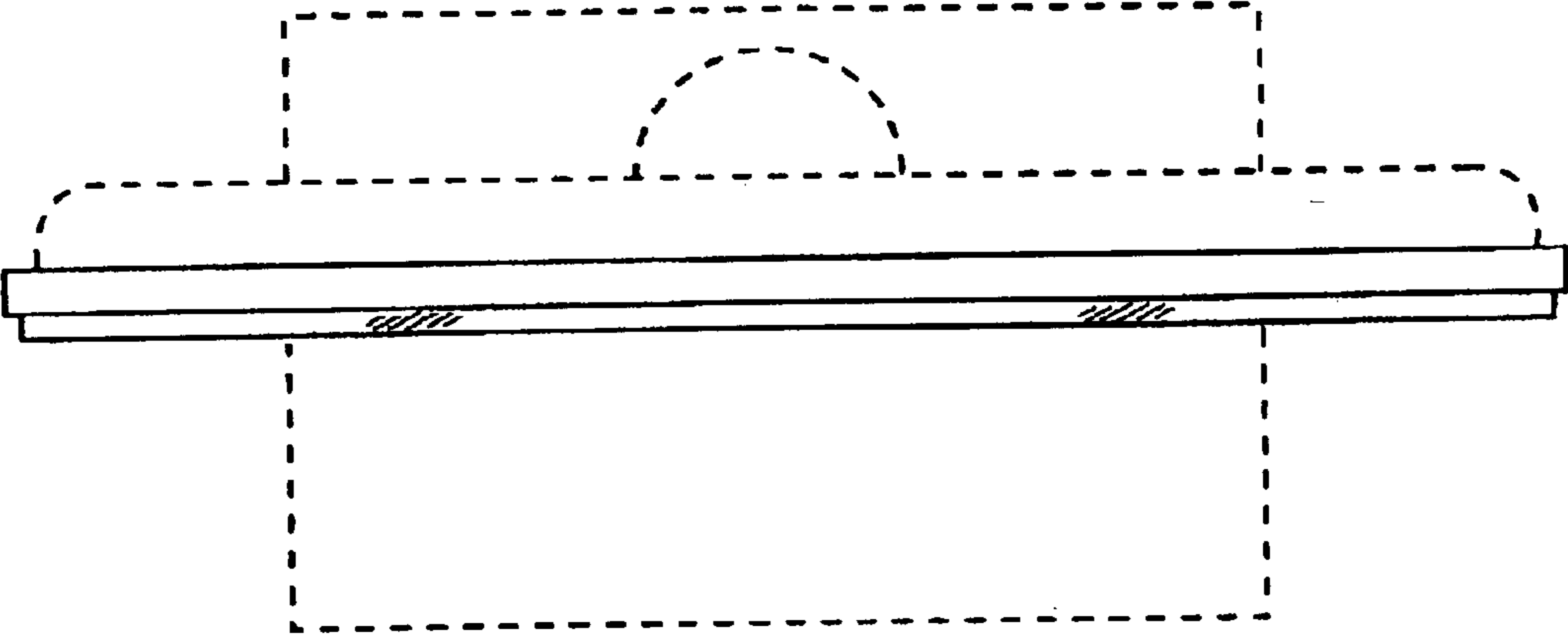

FIG. 26

