



US00D512380S

(12) **United States Design Patent** (10) **Patent No.:** **US D512,380 S**
Shimizu et al. (45) **Date of Patent:** **** Dec. 6, 2005**

(54) **ELECTRICAL CONNECTOR**
(75) **Inventors:** **Kazuomi Shimizu, Aichi (JP); Akihiko Onchi, Aichi (JP); Daisuke Miyachi, Aichi (JP)**
(73) **Assignee:** **J.S.T. Mfg. Co., Ltd., Osaka (JP)**
(**) **Term:** **14 Years**

JP D1139132 S 4/2002
JP D1142410 S 6/2002
JP D1142925 S 6/2002
JP D1156383 S 10/2002
JP D1156384 S 10/2002
JP D1172560 S 5/2003
JP D1172564 S 5/2003
JP D1172566 S 5/2003
JP D1180010 S 7/2003
JP D1180302 S 7/2003

(21) **Appl. No.:** **29/213,864**

(22) **Filed:** **Sep. 24, 2004**

(30) **Foreign Application Priority Data**

Mar. 26, 2004 (JP) 2004-009148

(51) **LOC (8) Cl.** **13-03**

(52) **U.S. Cl.** **D13/147**

(58) **Field of Search** D13/146-147,
D13/199; 439/62, 260, 325, 329, 395, 422,
492, 495, 499, 607

(56) **References Cited**

U.S. PATENT DOCUMENTS

D371,541 S * 7/1996 Ezaki D13/147
5,545,051 A * 8/1996 Summers et al. 439/350
6,033,238 A * 3/2000 Fogg et al. 439/108
D451,885 S * 12/2001 Hisatomi et al. D13/147
6,699,066 B2 * 3/2004 Wu 439/495
D491,527 S * 6/2004 Fan D13/147
D501,829 S * 2/2005 Kimura et al. D13/147
D502,921 S * 3/2005 Zhang et al. D13/147
2004/0248450 A1 * 12/2004 Masaki et al. 439/325

FOREIGN PATENT DOCUMENTS

JP D1138433 S 4/2002

OTHER PUBLICATIONS

Catalog, "Connectors Catalog / SHL Connector," vol. 111, pp. 6-7 JST Mfg. Co., Ltd. (Nov. 2002).

* cited by examiner

Primary Examiner—Stella Reid

Assistant Examiner—Daniel Bui

(74) *Attorney, Agent, or Firm*—Rader, Fishman & Grauer PLLC

(57) **CLAIM**

The ornamental design for an electrical connector, as shown.

DESCRIPTION

FIG. 1 is a perspective view of an electrical connector showing our new design;
FIG. 2 is a front elevational view thereof;
FIG. 3 is a rear elevational view thereof;
FIG. 4 is a top plan view thereof;
FIG. 5 is a bottom plan view thereof;
FIG. 6 is a right side elevational view thereof; and,
FIG. 7 is a left side elevational view thereof.

1 Claim, 4 Drawing Sheets

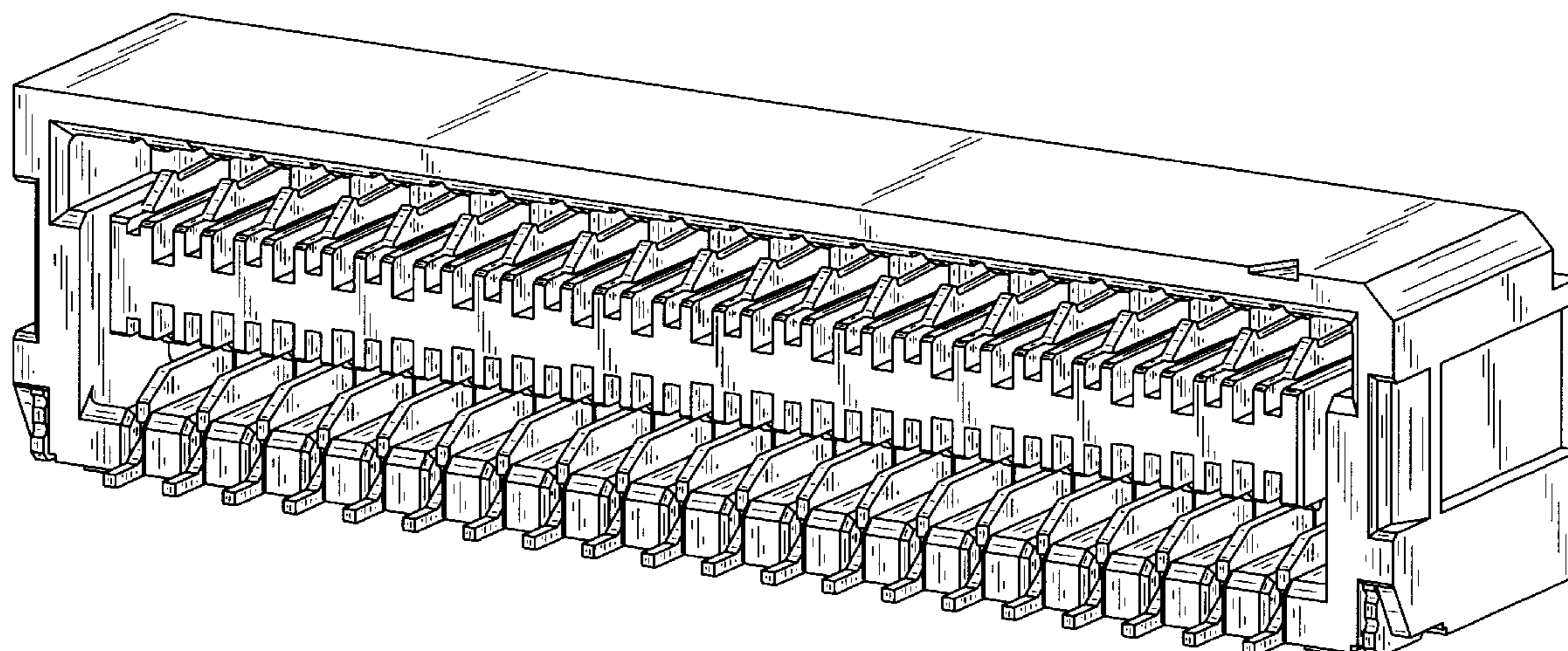
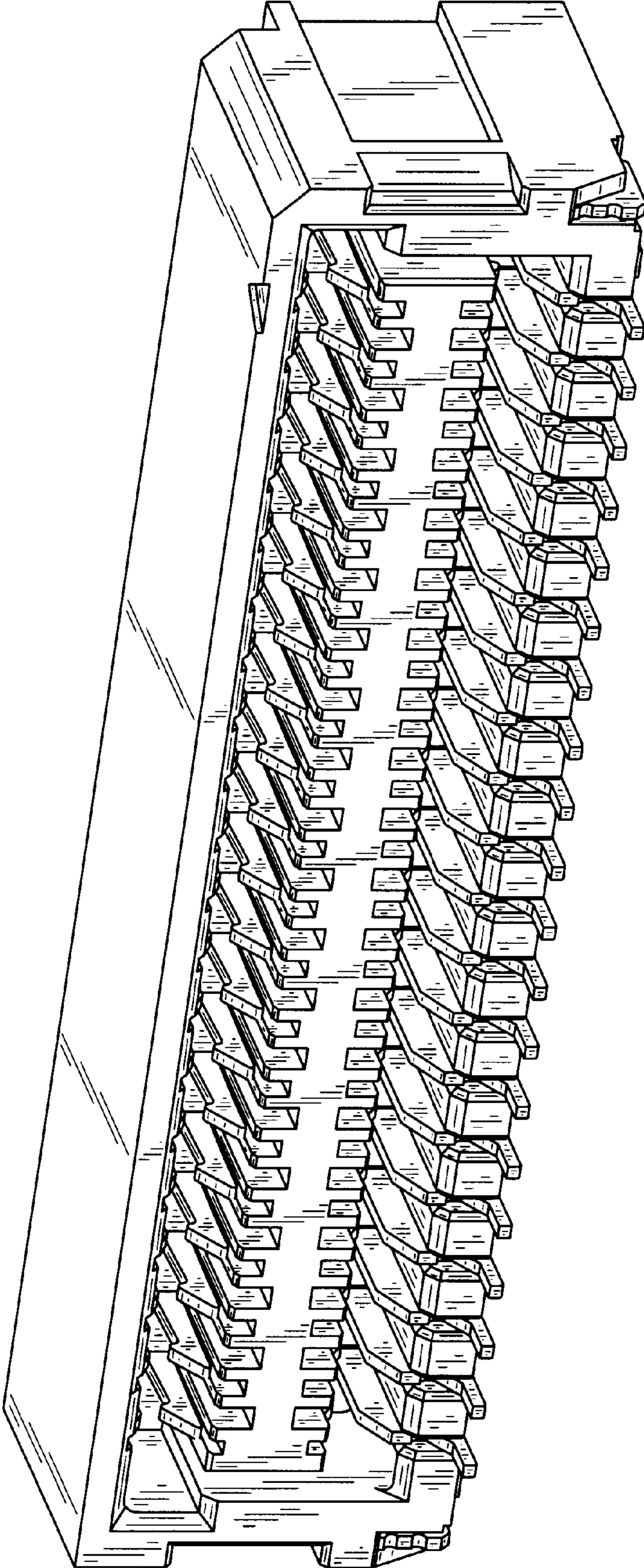

Fig. 1



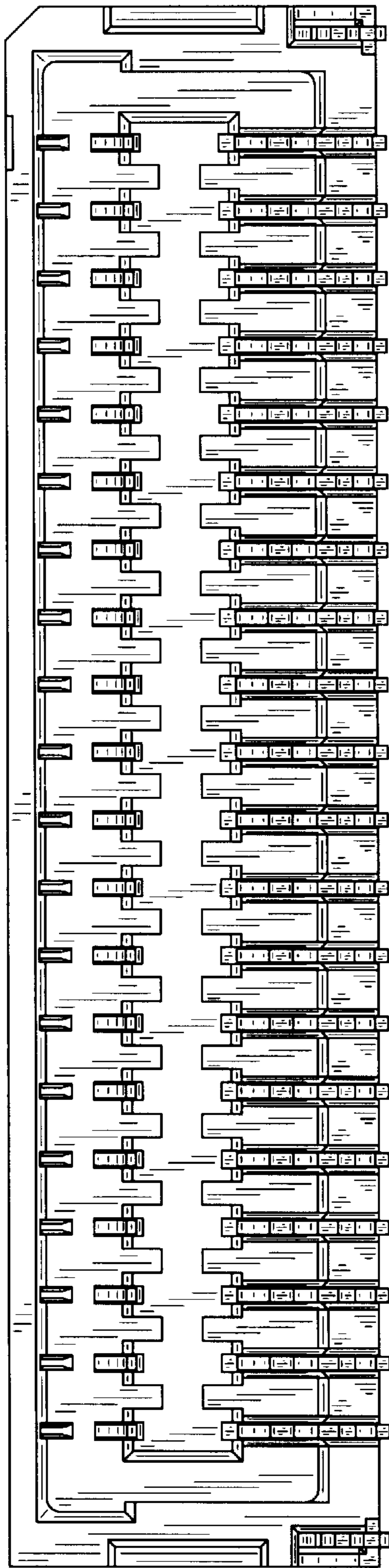

Fig. 2

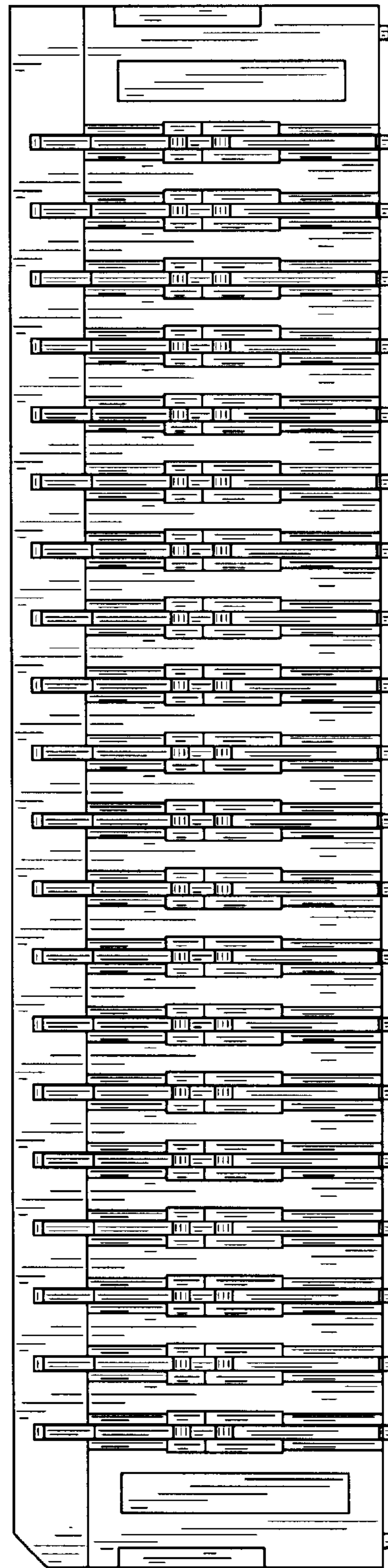

Fig. 3

Fig.4

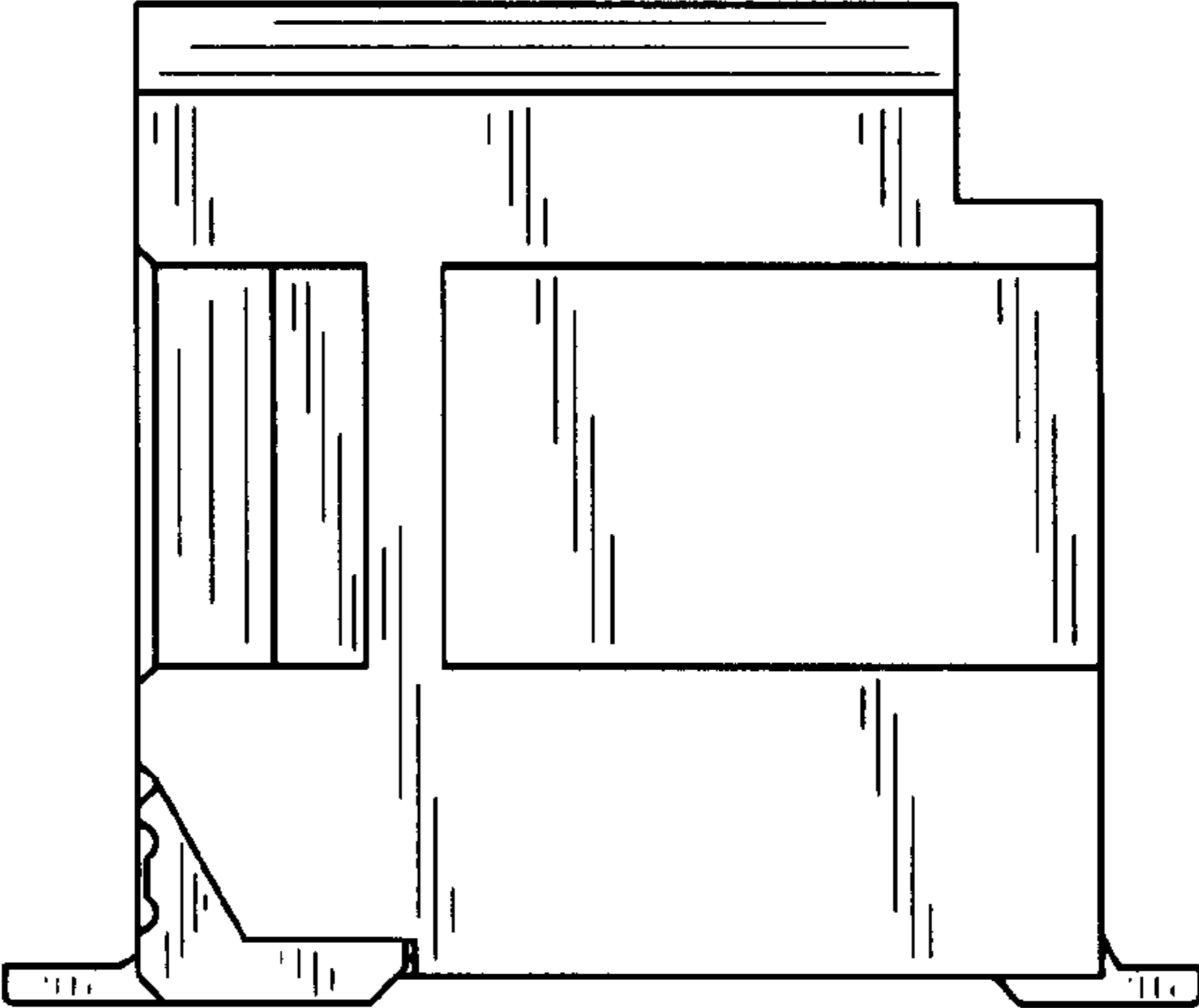
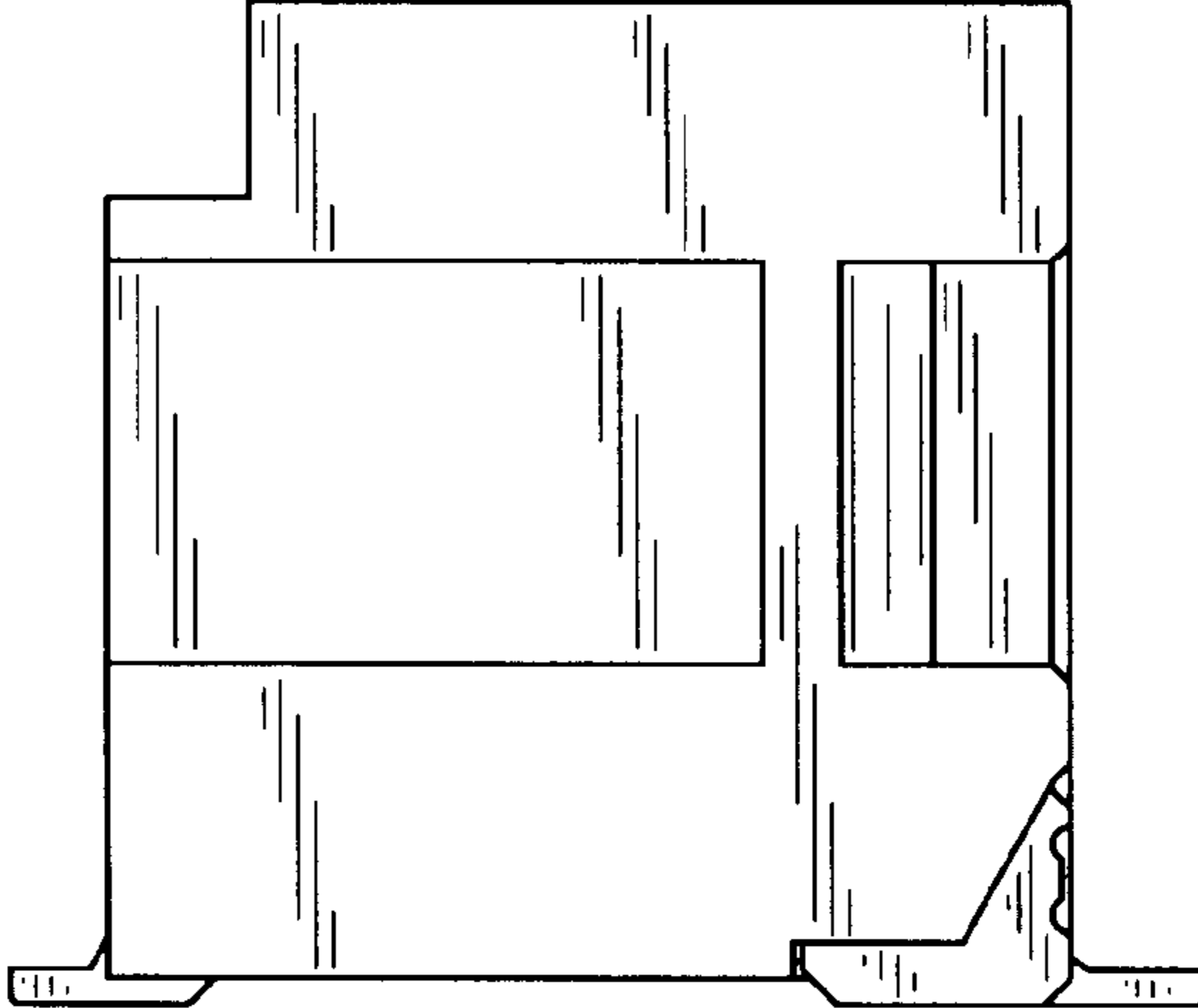

Fig.5



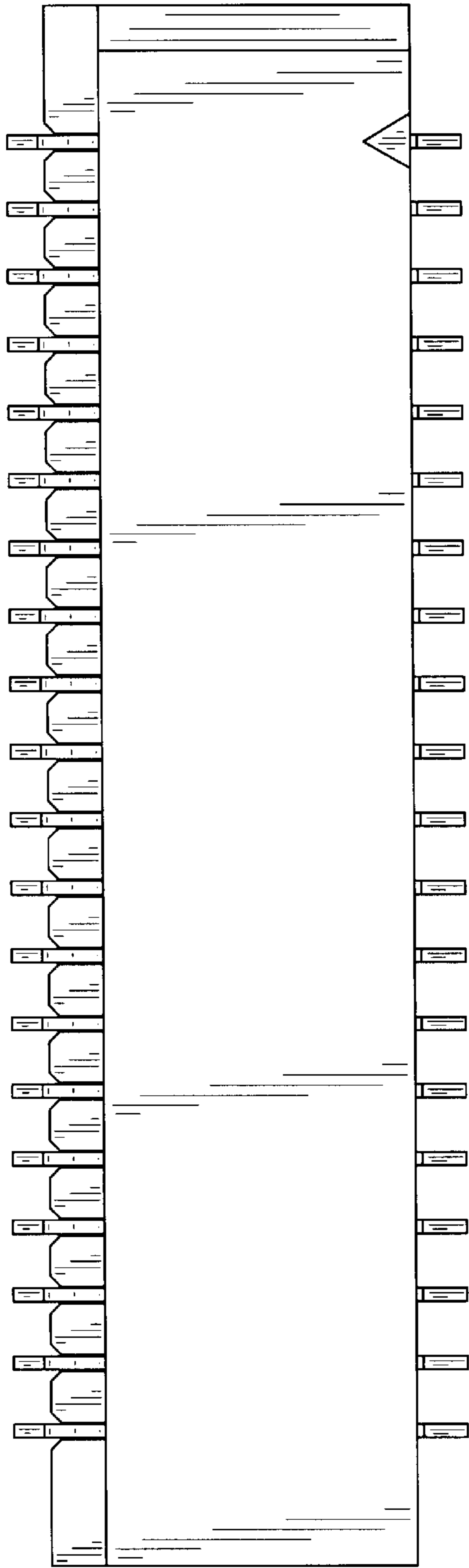

Fig. 6

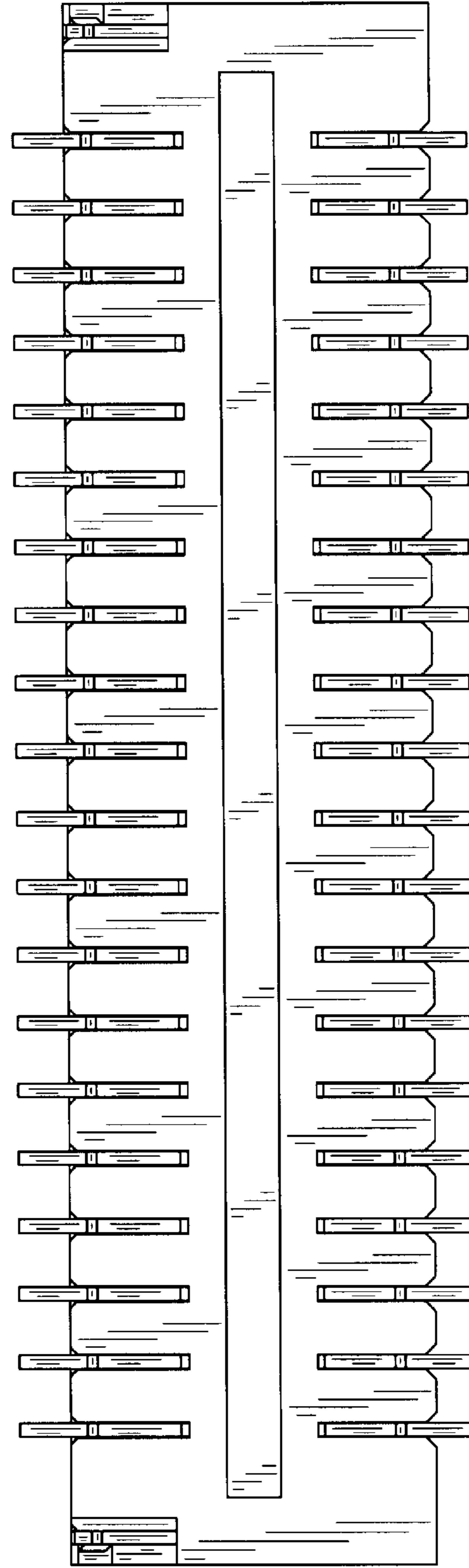

Fig. 7