



US00D512314S

(12) **United States Design Patent**
Cervantes

(10) **Patent No.:** **US D512,314 S**

(45) **Date of Patent:** **** Dec. 6, 2005**

(54) **CONTAINER ASSEMBLY**

(75) **Inventor:** **Javier Cervantes**, Guanajuato (MX)

(73) **Assignee:** **Ireri Andessi, S.A. de C.V.**, Guanajuato (MX)

(**) **Term:** **14 Years**

(21) **Appl. No.:** **29/194,570**

(22) **Filed:** **Nov. 28, 2003**

(51) **LOC (8) Cl.** **09-01**

(52) **U.S. Cl.** **D9/504**

(58) **Field of Search** D9/500, 502–504,
D9/506, 509, 511, 513, 515–516, 518, 529,
537–541, 543, 549, 558, 417, 420, 423,
438, 447, 452; D7/510–511, 603–606, 615;
D3/300; 215/235, 382–384, 396, 398; D6/515;
220/270

(56) **References Cited**

U.S. PATENT DOCUMENTS

D113,416 S	*	2/1939	Barrett	D9/500
D209,788 S	*	1/1968	Cheladze	D9/452
D226,705 S	*	4/1973	Zundel	D9/506
3,734,333 A	*	5/1973	Foss	D9/438 X
D249,469 S	*	9/1978	Russert	D9/423
D258,348 S	*	2/1981	Hoyt	D9/529
D307,238 S	*	4/1990	May	D9/504
D319,875 S	*	9/1991	Lackey et al.	D9/529 X
5,108,003 A	*	4/1992	Granofsky	220/269 X
D327,424 S	*	6/1992	Pierce	D9/518
D347,973 S	*	6/1994	McBride	D7/606 X
D360,340 S	*	7/1995	Hitch et al.	D7/604
D396,916 S	*	8/1998	Ochs, Sr.	D9/518 X
D421,719 S	*	3/2000	Wells et al.	D9/438
D451,807 S	*	12/2001	Goettner	D9/504
D466,814 S	*	12/2002	Hurlburt	D9/504
D474,651 S	*	5/2003	Ward	D7/615
D480,003 S	*	9/2003	Blades	D9/529

* cited by examiner

Primary Examiner—Carol Rademaker

(74) *Attorney, Agent, or Firm*—Connolly Bove Lodge & Hutz LLP

(57) **CLAIM**

The ornamental design for a container assembly, as shown and described.

DESCRIPTION

FIG. 1 is a perspective view of a container assembly showing my new design;

FIG. 2 is a front elevation thereof;

FIG. 3 is a rear elevation thereof;

FIG. 4 is a left side elevation thereof, the right side elevation view being a mirror image;

FIG. 5 is a top plan view thereof;

FIG. 6 is a bottom plan view thereof;

FIG. 7 is a front elevation view of the cap portion of the container assembly, shown separately for clarity of illustration;

FIG. 8 is a rear elevation view thereof;

FIG. 9 is a left side elevation thereof, the right side elevation view being a mirror image;

FIG. 10 is a top plan view thereof, rotated 90° from FIG. 7;

FIG. 11 is a side elevation view of the container portion of the container assembly, shown separately for clarity of illustration;

FIG. 12 is a front elevation thereof;

FIG. 13 is a top plan view thereof; and,

FIG. 14 is an exploded perspective view of the container assembly of FIG. 1, showing the independent parts of the container assembly.

The broken lines shown in the drawings are for environmental purposes only and form no part of the claimed design.

1 Claim, 9 Drawing Sheets

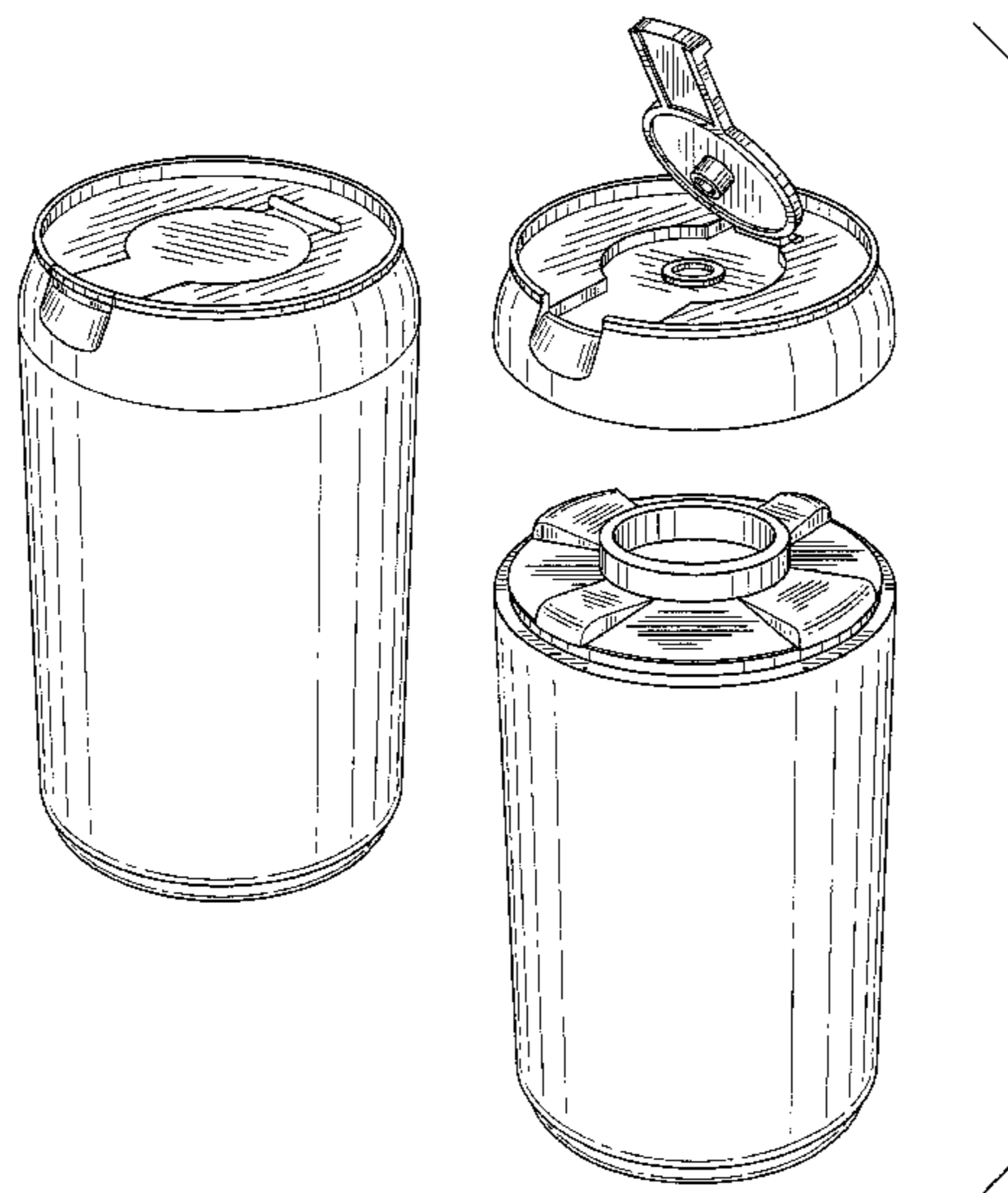

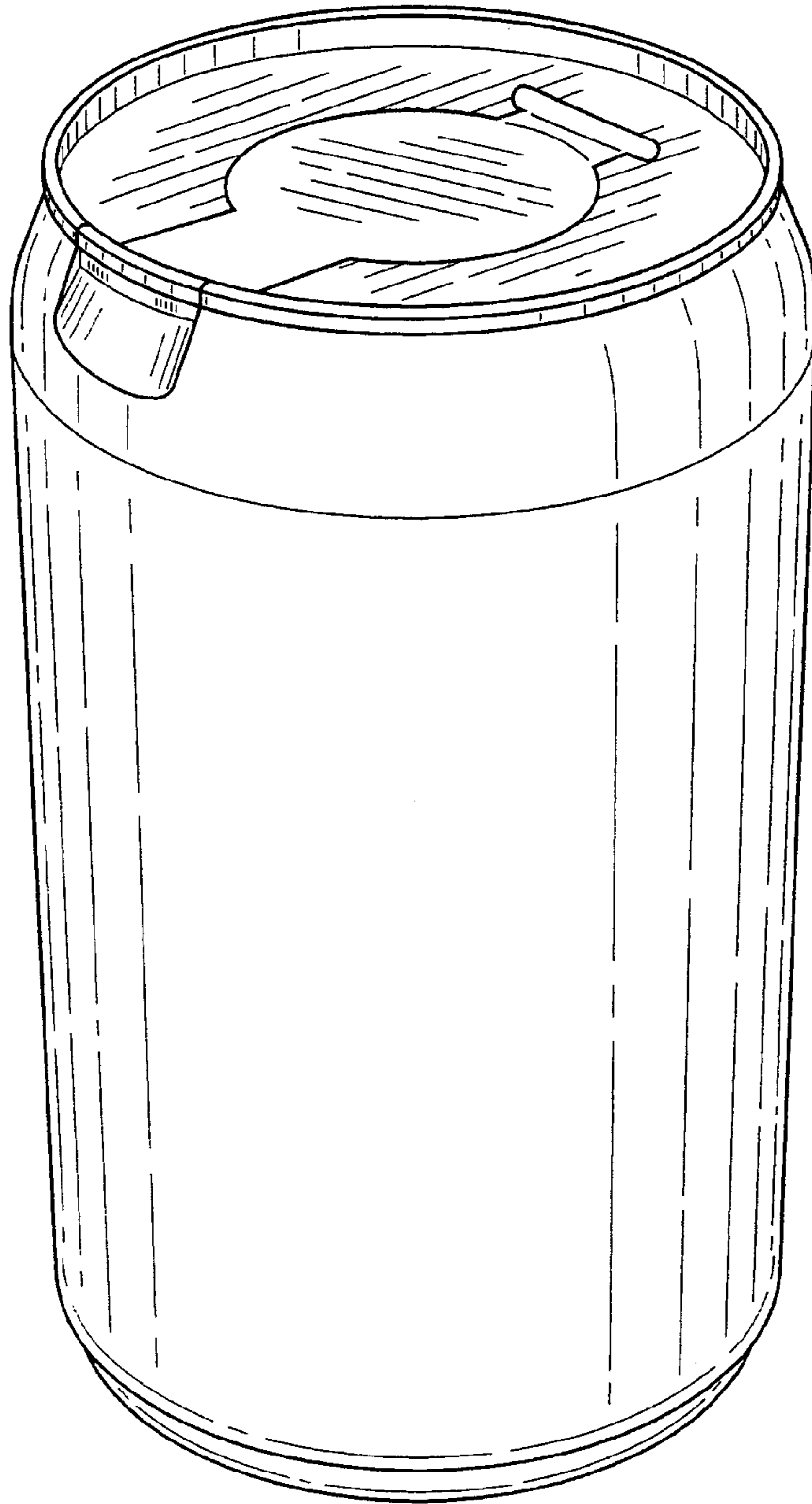

FIG. 1

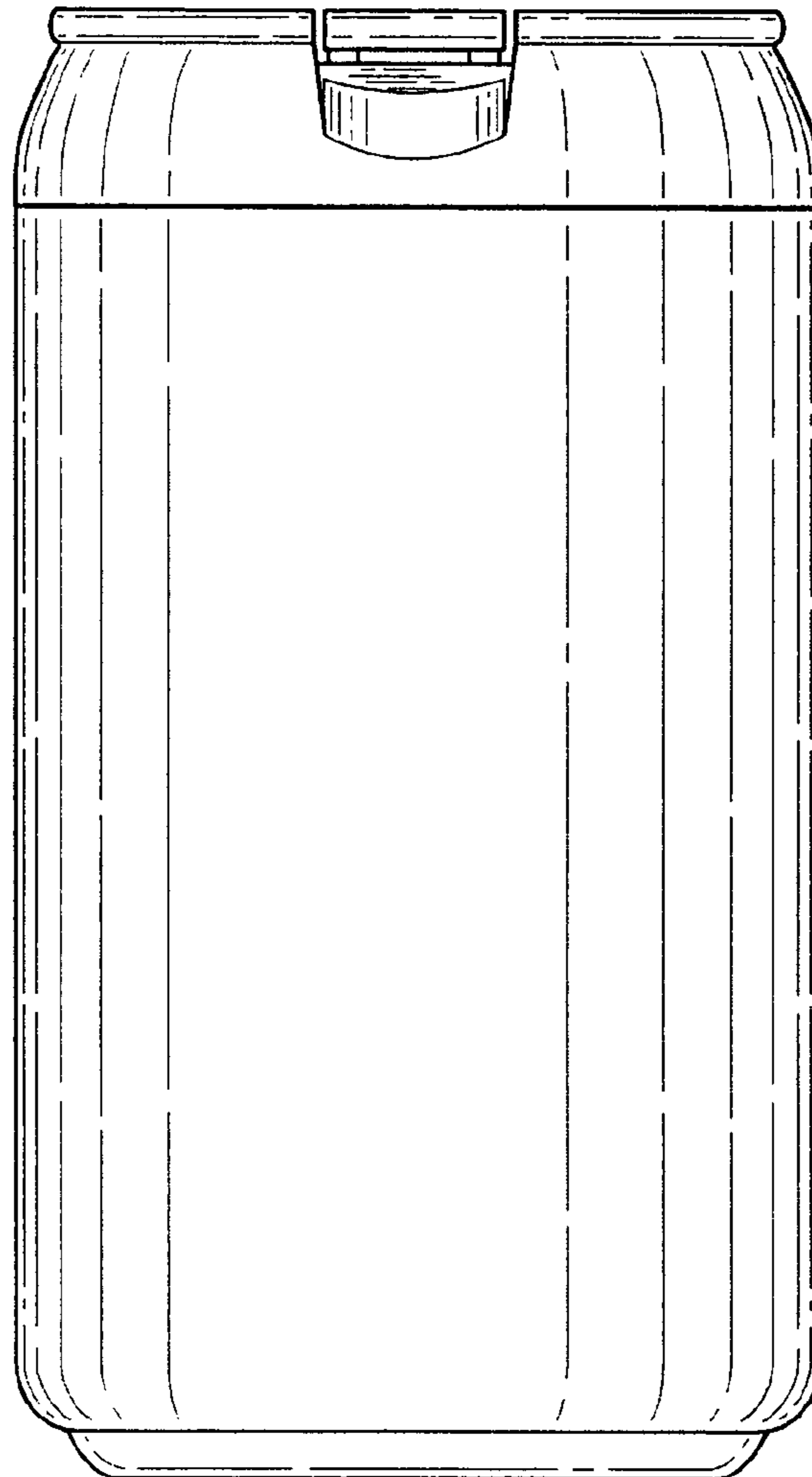

FIG. 2

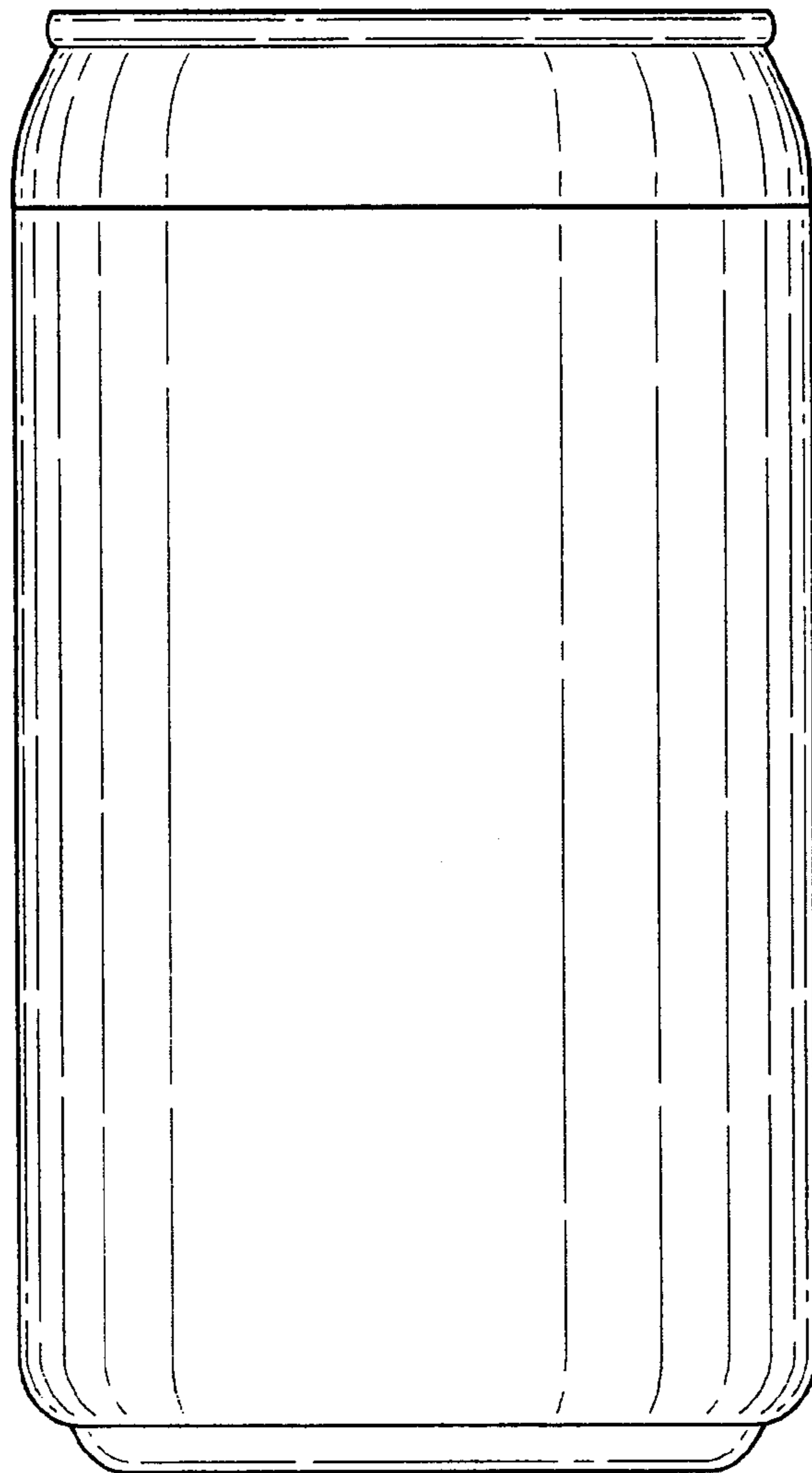

FIG. 3

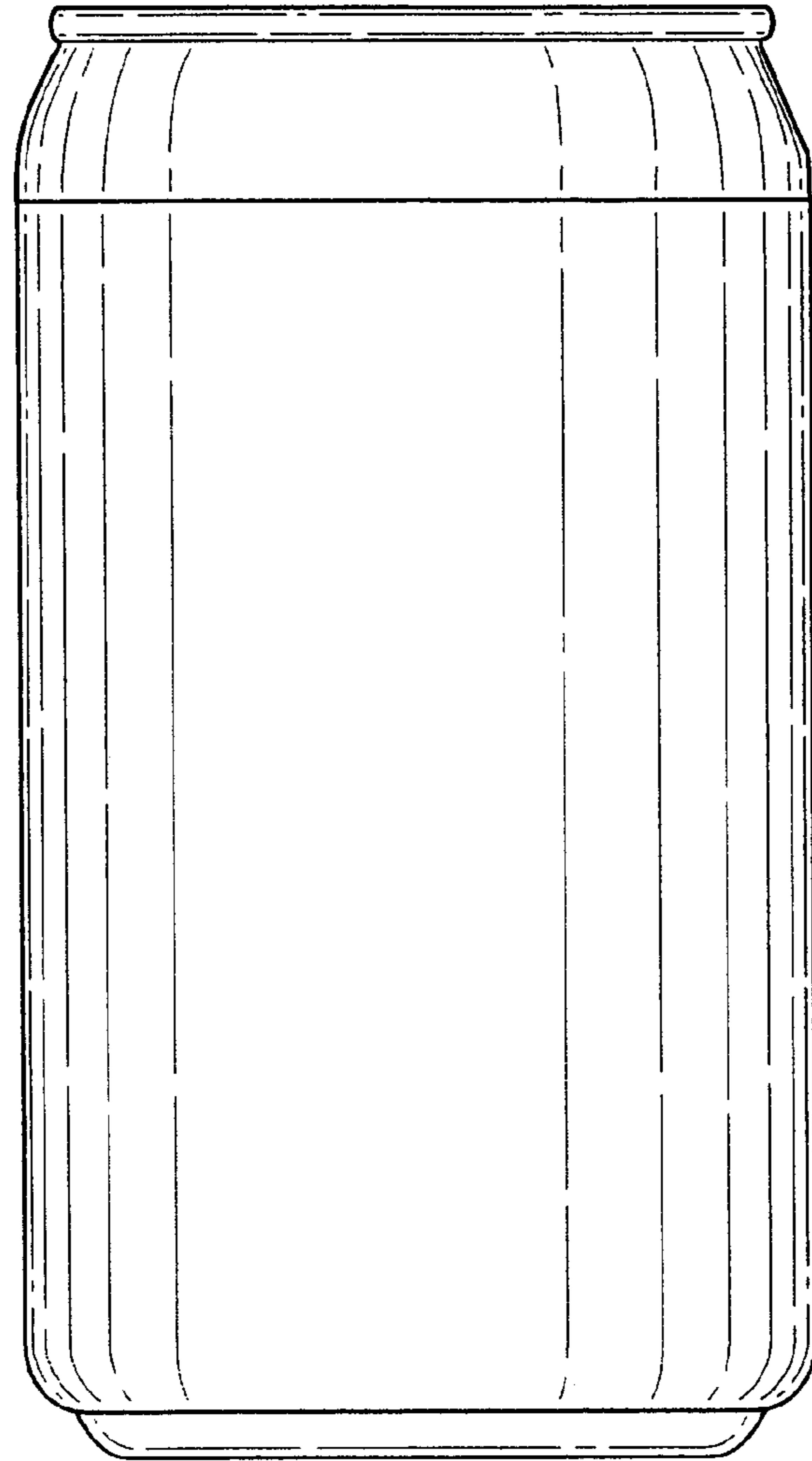

FIG. 4

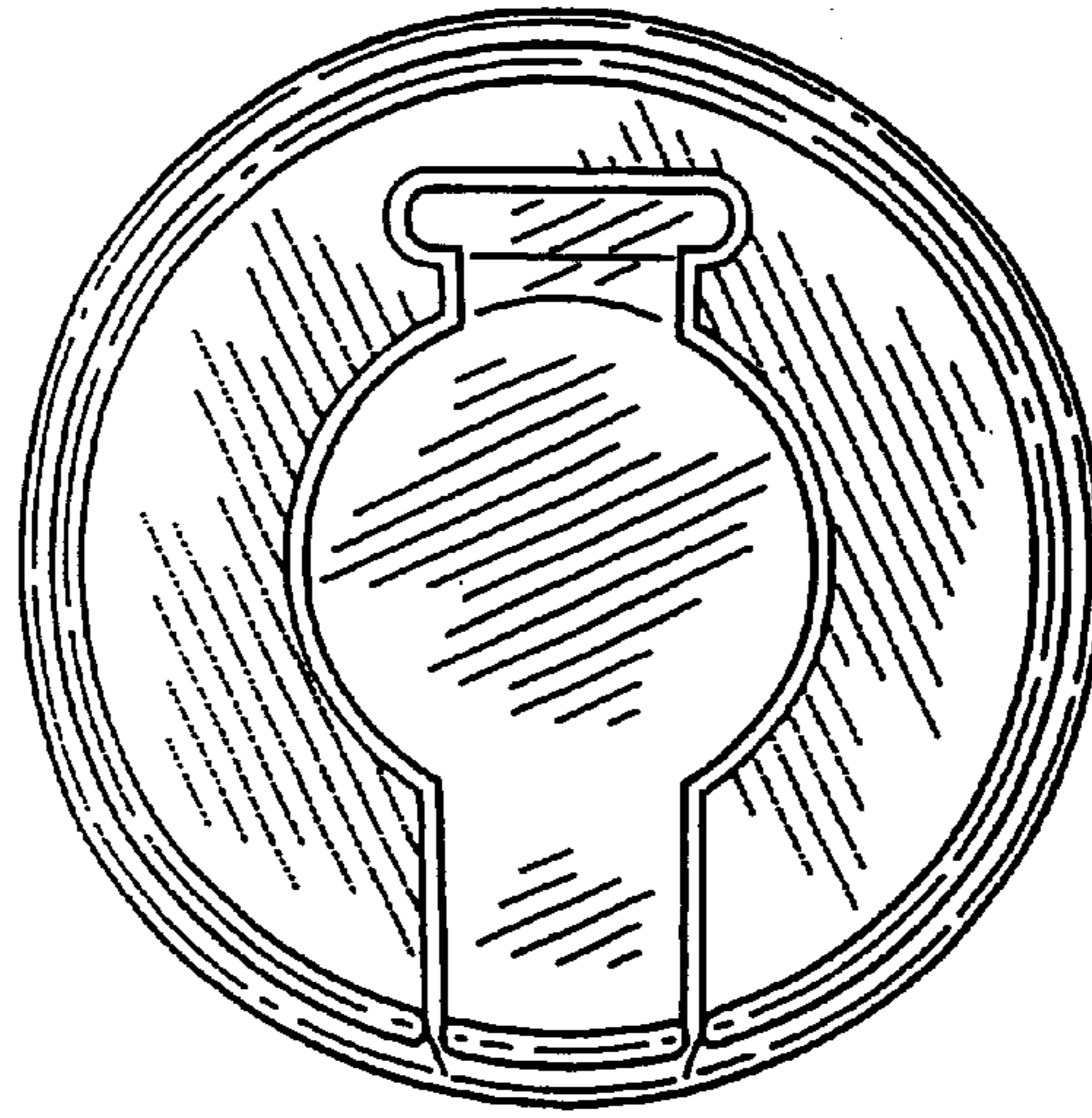

FIG. 5

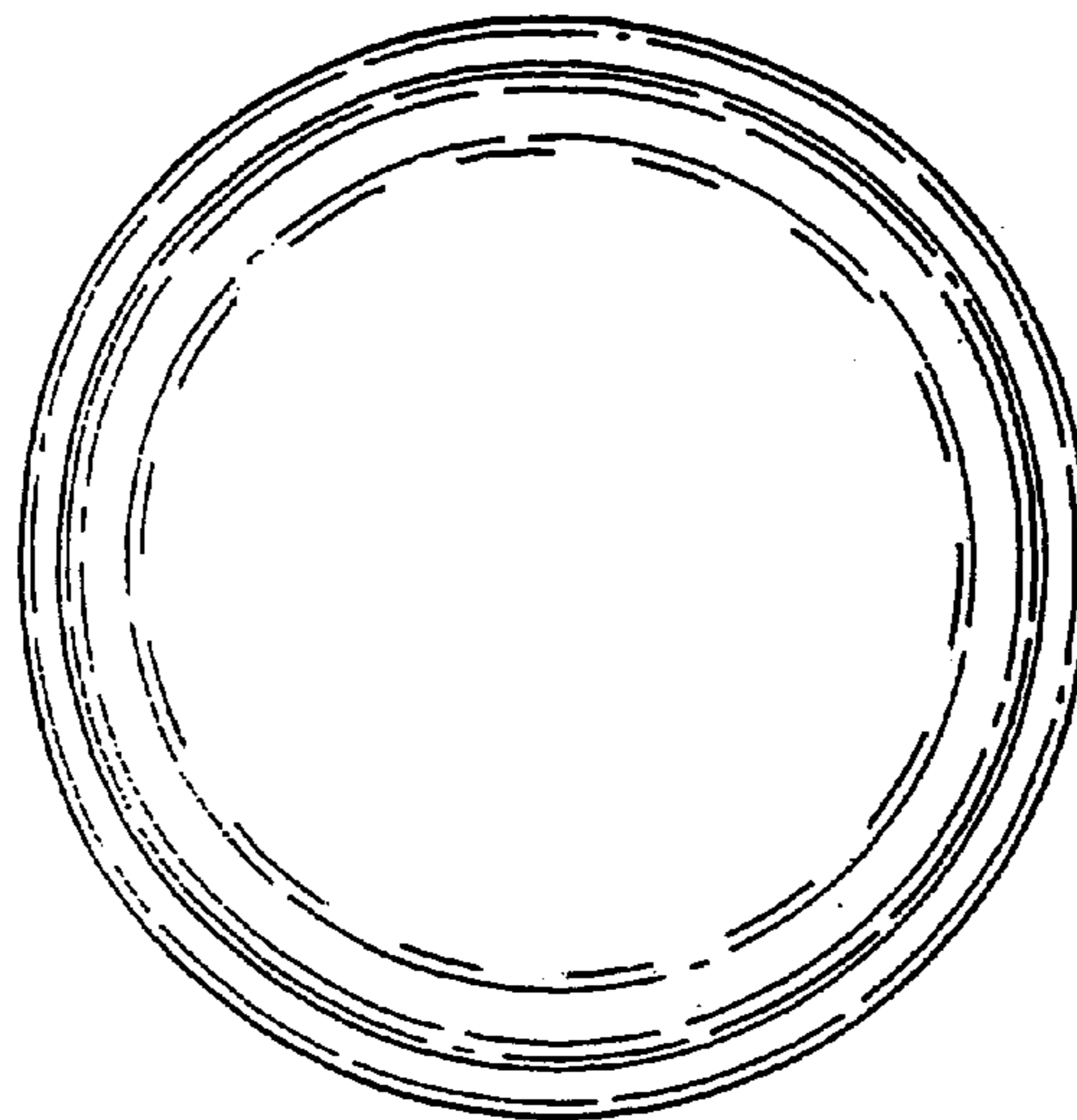

FIG. 6

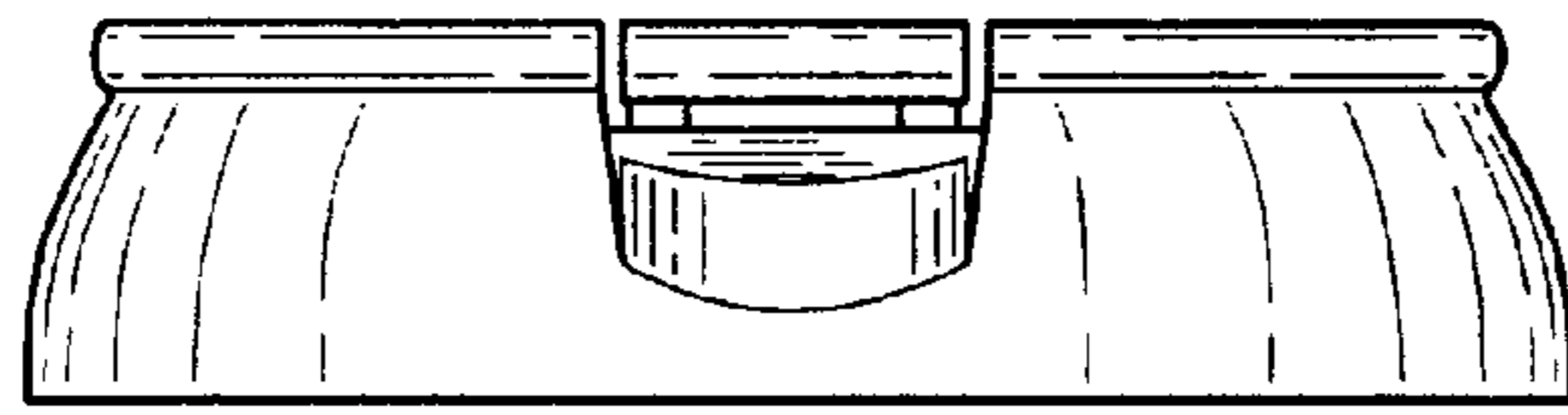

FIG. 7

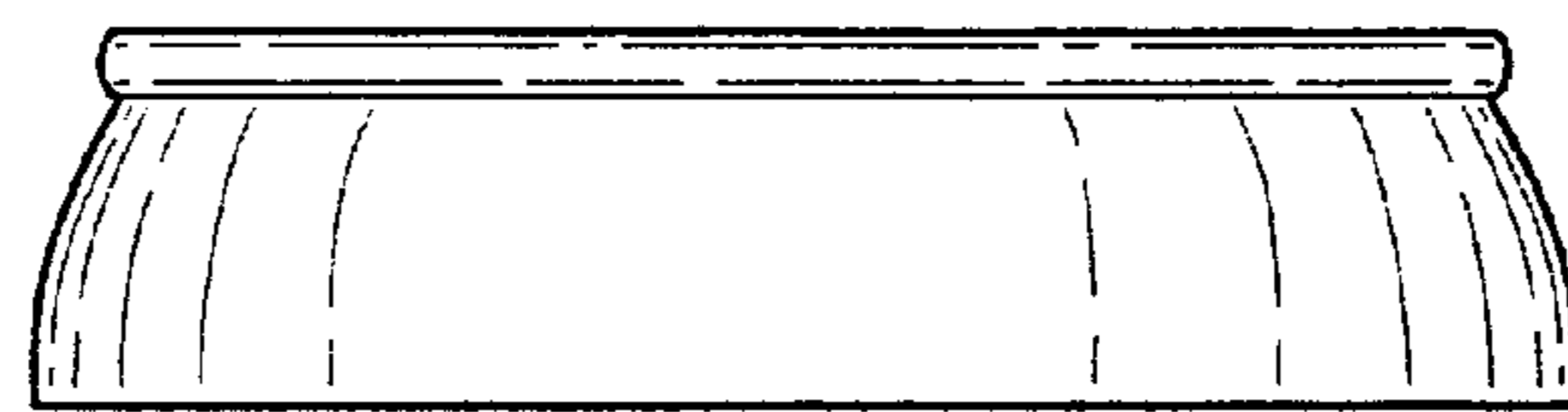

FIG. 8

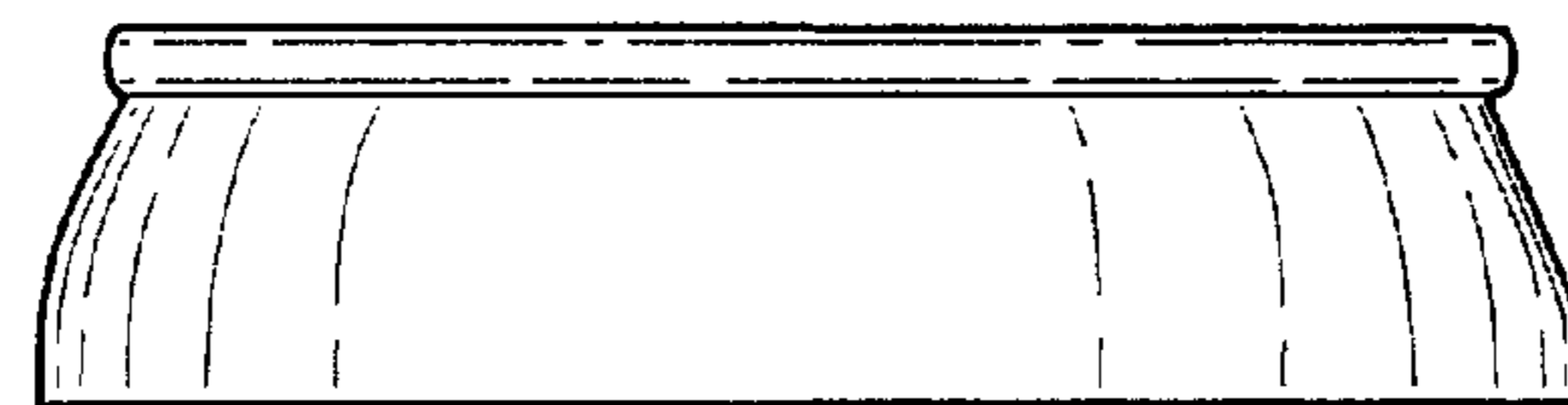

FIG. 9

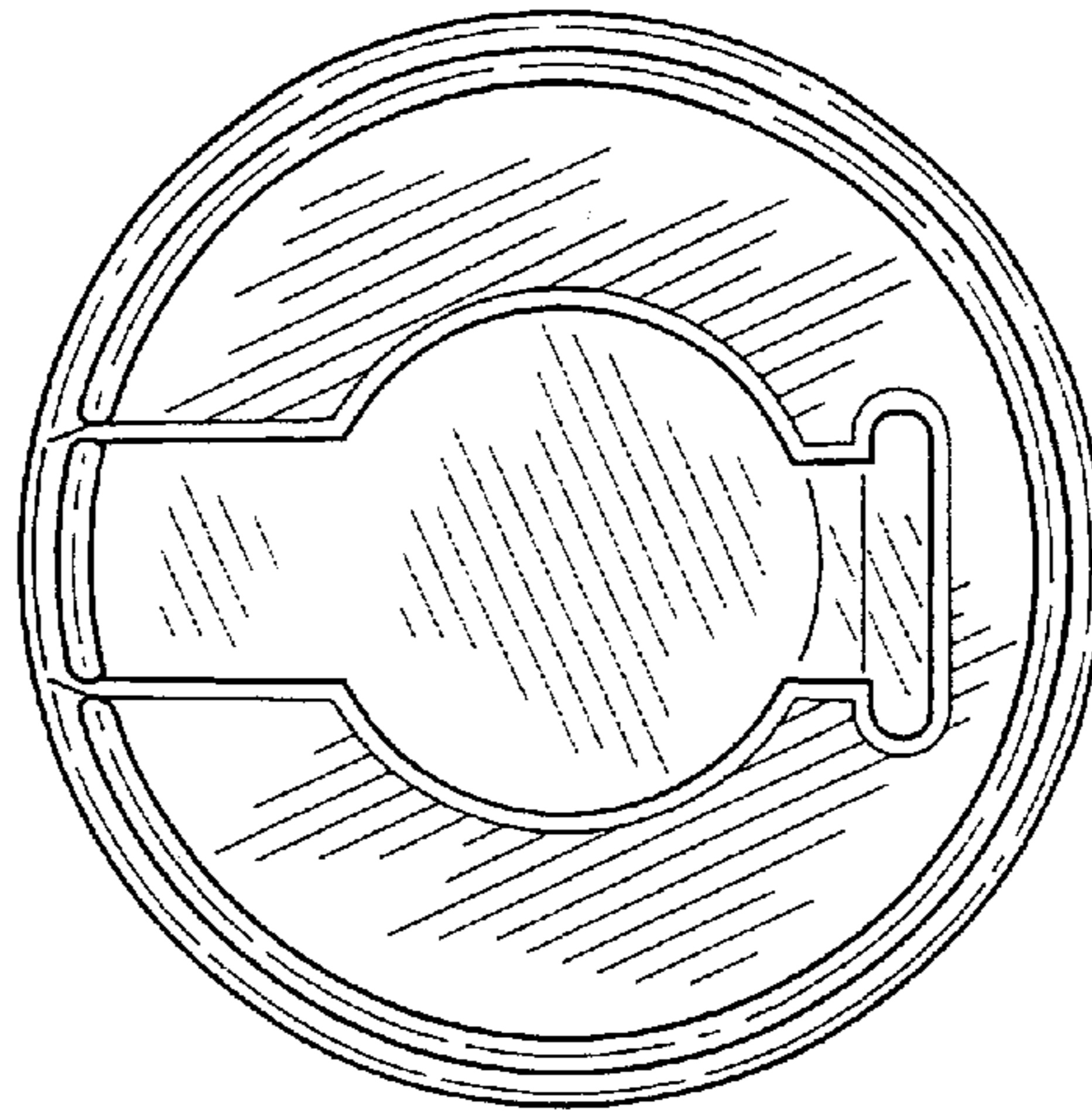

FIG. 10

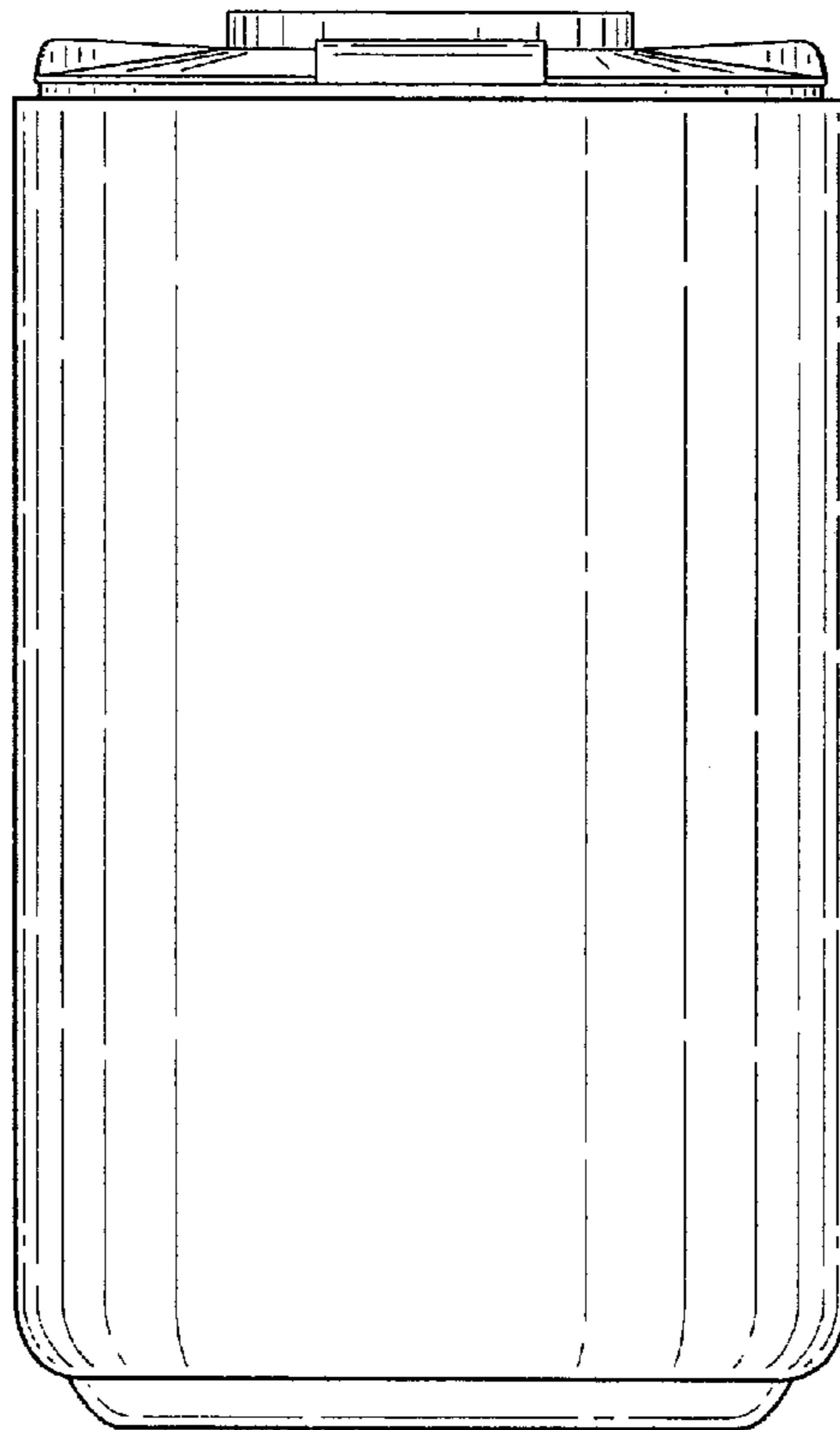

FIG. 11

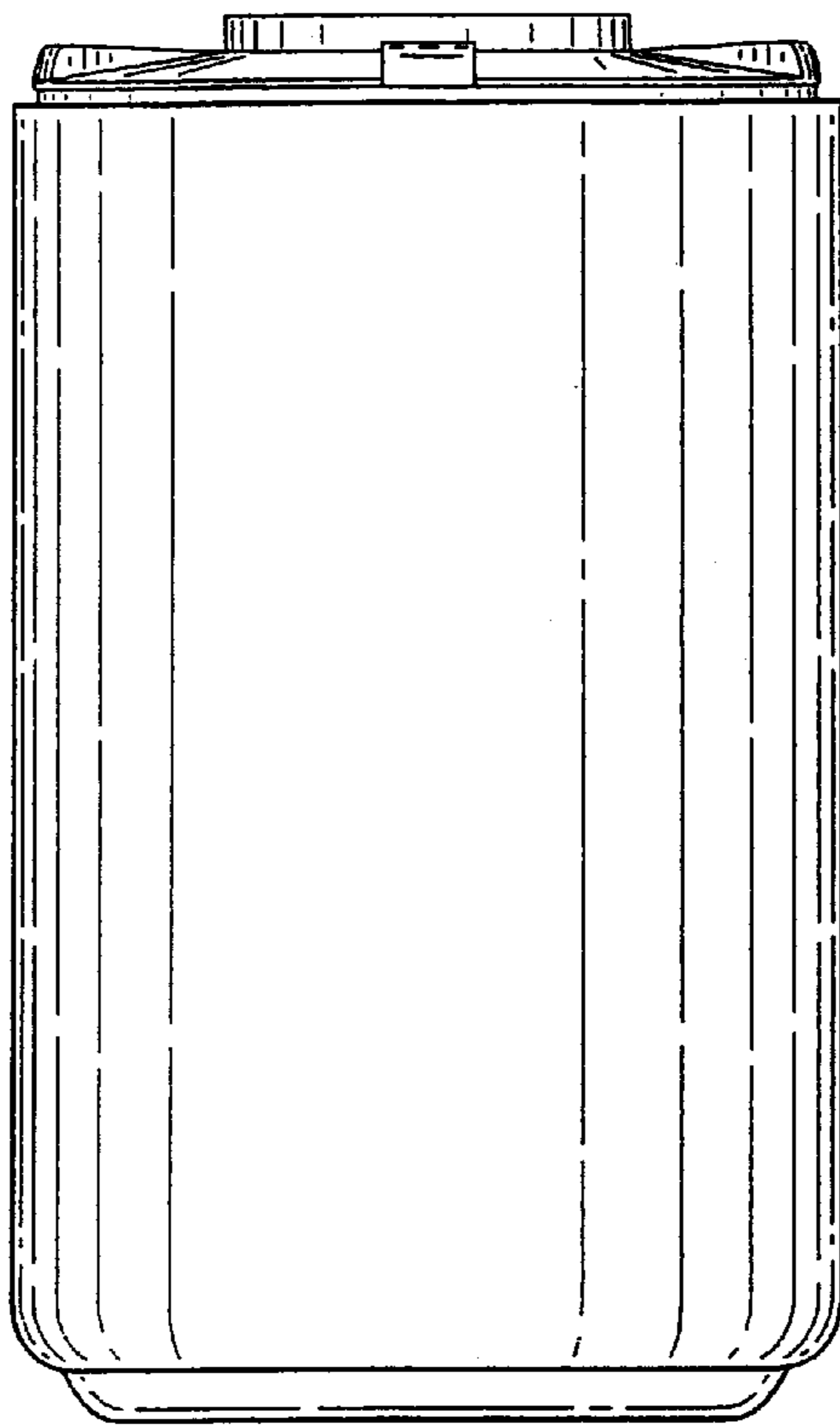

FIG. 12

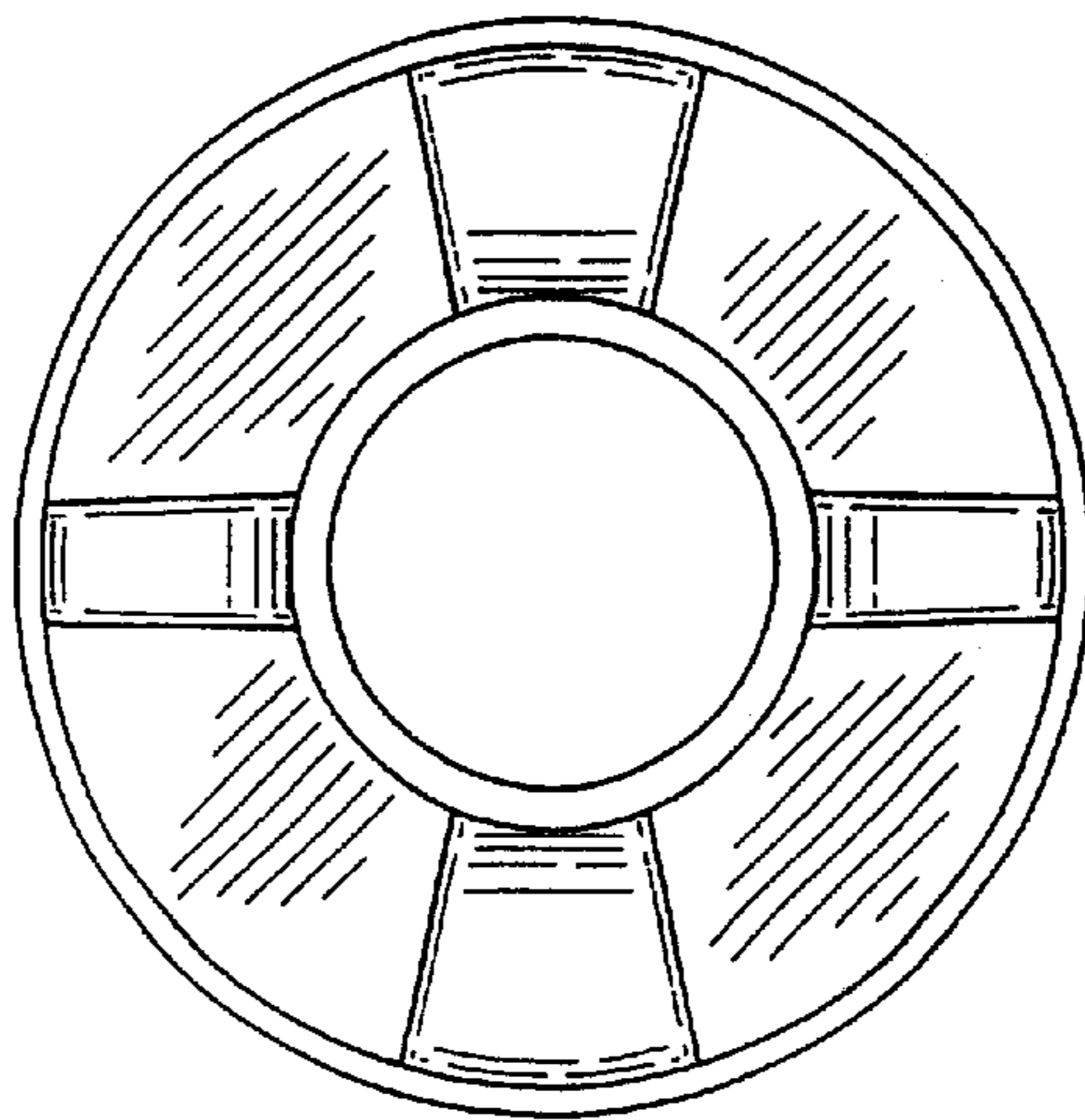

FIG. 13

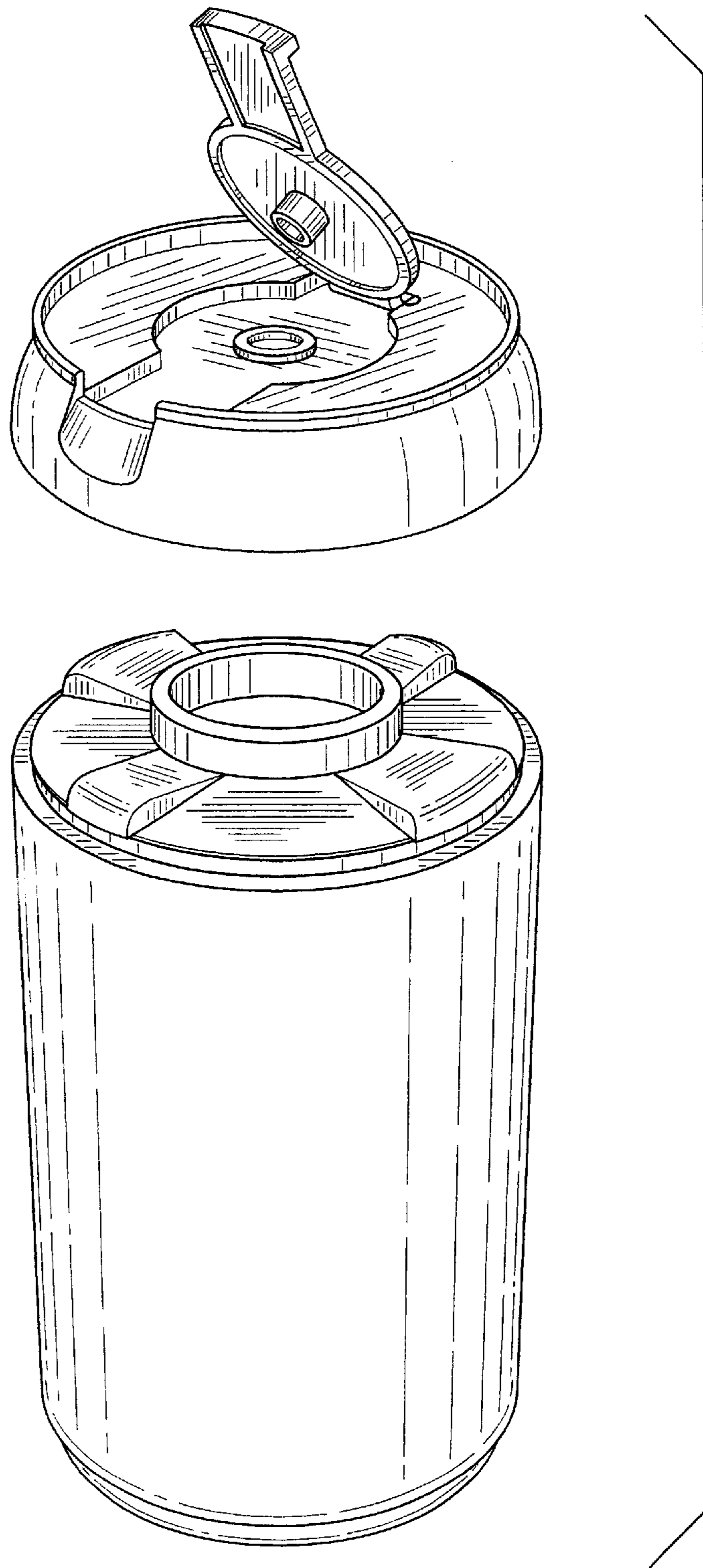

FIG. 14