

US00D512274S

(12) **United States Design Patent**
Cabey

(10) **Patent No.:** **US D512,274 S**
(45) **Date of Patent:** **** Dec. 6, 2005**

(54) **FULLY INSULATED SNACK HOLDER**

Primary Examiner—Terry A. Wallace

(76) **Inventor:** **Bernard Lewis Cabey**, 606 E. 239th
St., #1, Bronx, NY (US) 10470

(57) **CLAIM**

I claim the ornamental design for the fully insulated snack holder, as shown and described.

(**) **Term:** **14 Years**

DESCRIPTION

(21) **Appl. No.:** **29/178,954**

FIG. 1 is the front elevation view of a fully insulated snack holder with a zippered top, and side “D” rings for connection to a web shoulder strap for carrying, and top web strap for hand carrying showing my new design;

(22) **Filed:** **Apr. 2, 2003**

(51) **LOC (8) Cl.** **07-01**

FIG. 2 is the rear view thereof, showing two web belt loops for carrying on a waistpack holder belt Or regular waist belt

(52) **U.S. Cl.** **D7/607**

(58) **Field of Search** D7/605–608; D3/273,
D3/276, 283–287, 289; 62/371, 372, 457.1–457.7;
383/97, 110, 113, 109; 220/592.2, 592.24,
592.25, 915.1, 915.2; 224/148.3, 148.1,
148.4, 148.7

FIG. 3 is a top plan view thereof, with a top web strap for hand carrying and two side “D” rings For connection to a web shoulder strap for carrying

(56) **References Cited**

U.S. PATENT DOCUMENTS

4,738,364	A	*	4/1988	Yeager	62/457.1
4,955,516	A	*	9/1990	Satterfield	62/457.2
5,421,172	A	*	6/1995	Jones	62/457.5
5,435,256	A	*	7/1995	Svehaug	220/592.2
6,027,249	A	*	2/2000	Bielinski	383/110
6,113,268	A	*	9/2000	Thompson	383/97

FIG. 4 is a bottom plan view thereof, with two side “D” rings for connection to a web shoulder Strap for carrying

FIG. 5 is a side elevation plan view thereof, the opposite side being identical, showing web strap with “D” Ring, zippered top with web strap for hand carrying; and,

FIG. 6 is a top plan view thereof, with an unzipped top, showing the inside compartment of The snack holder.

The broken lines are to show stitching.

* cited by examiner

1 Claim, 6 Drawing Sheets

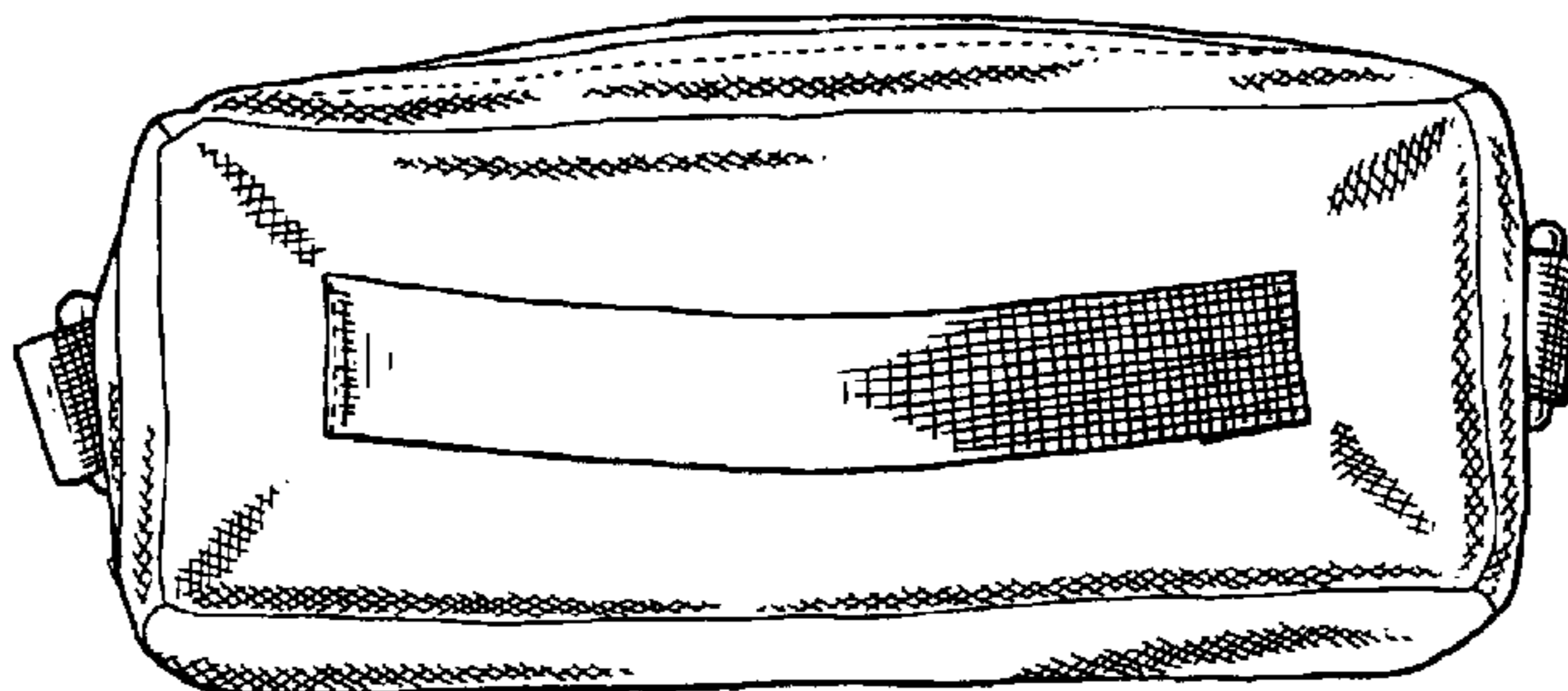
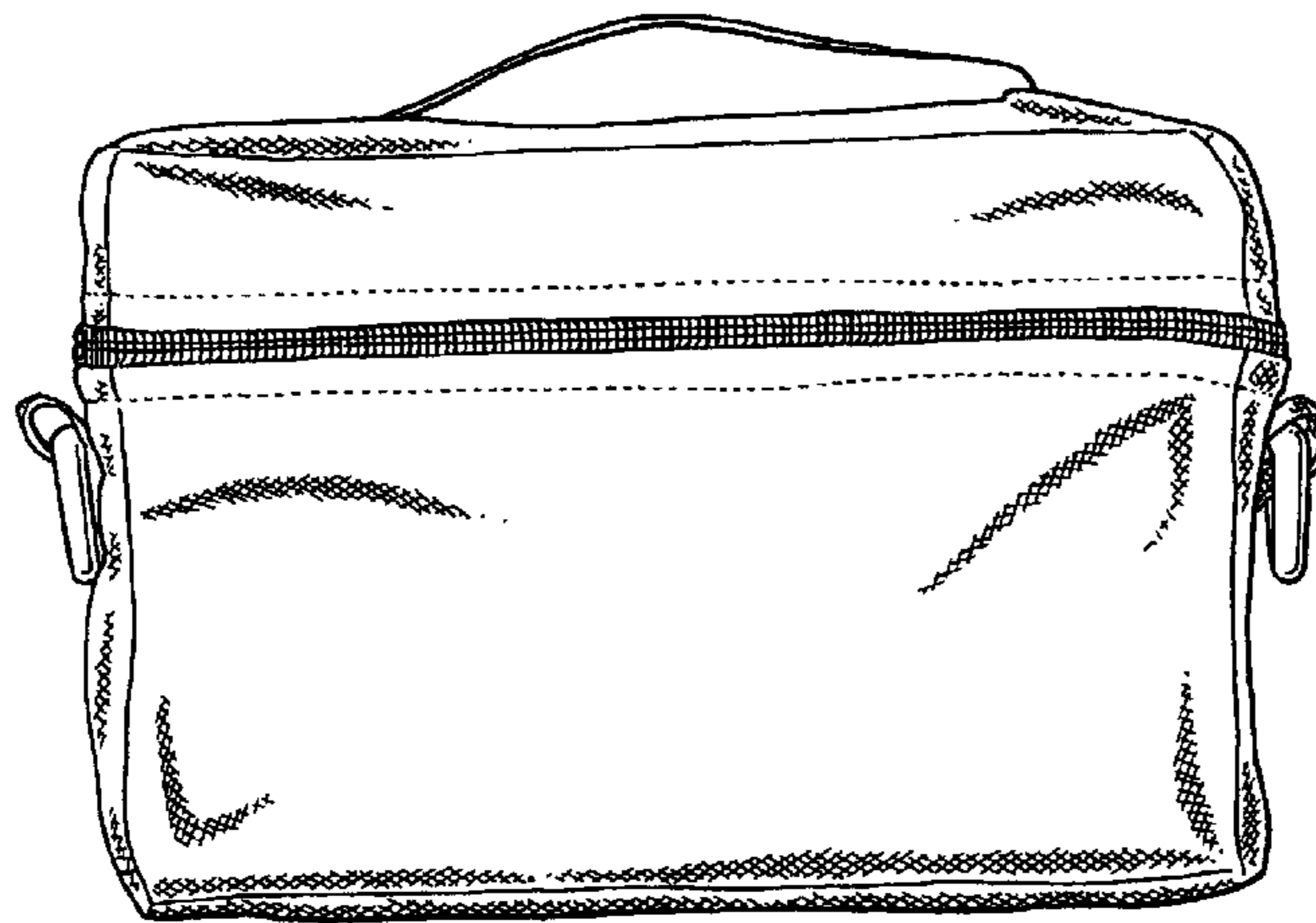

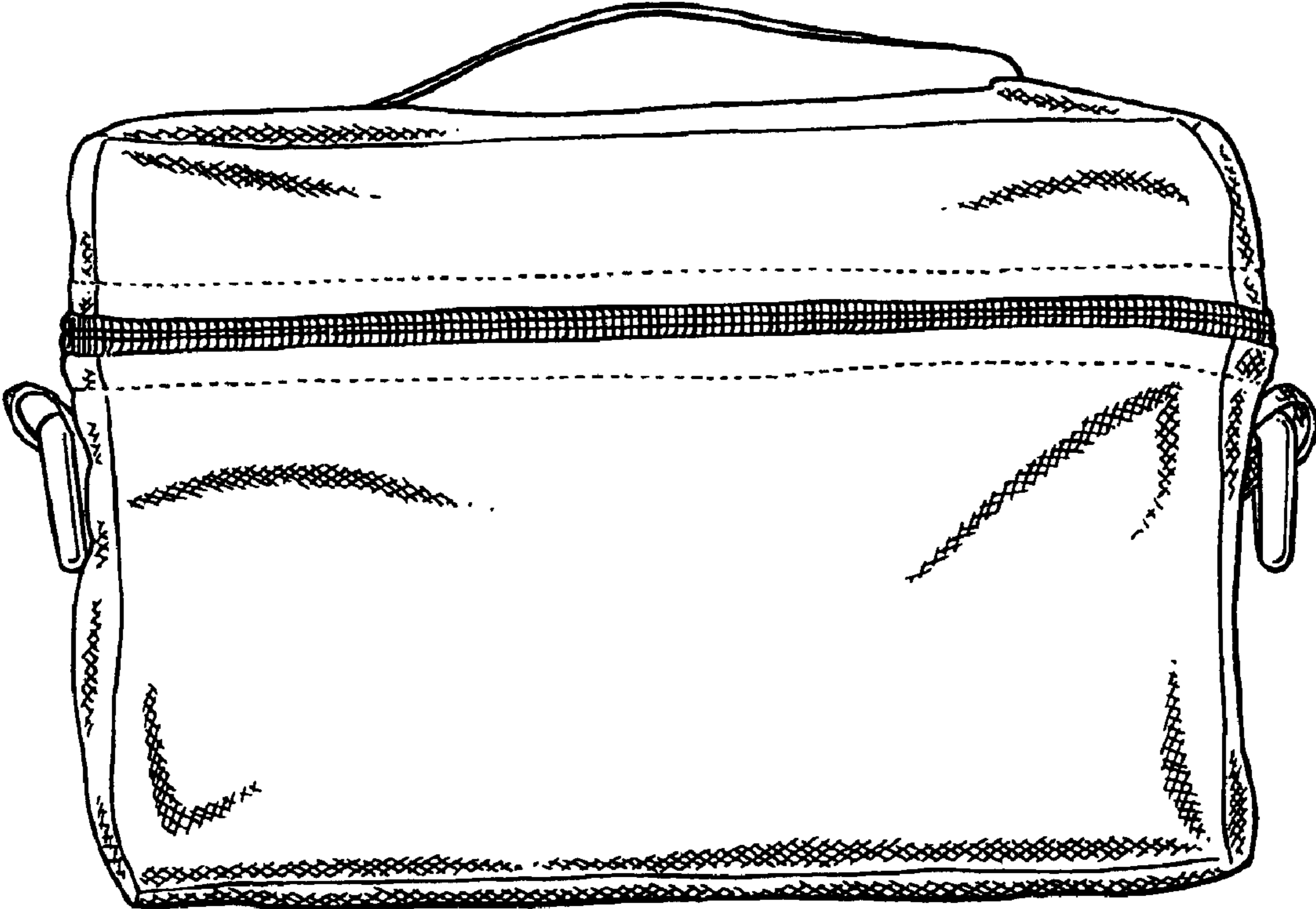

FIG.1

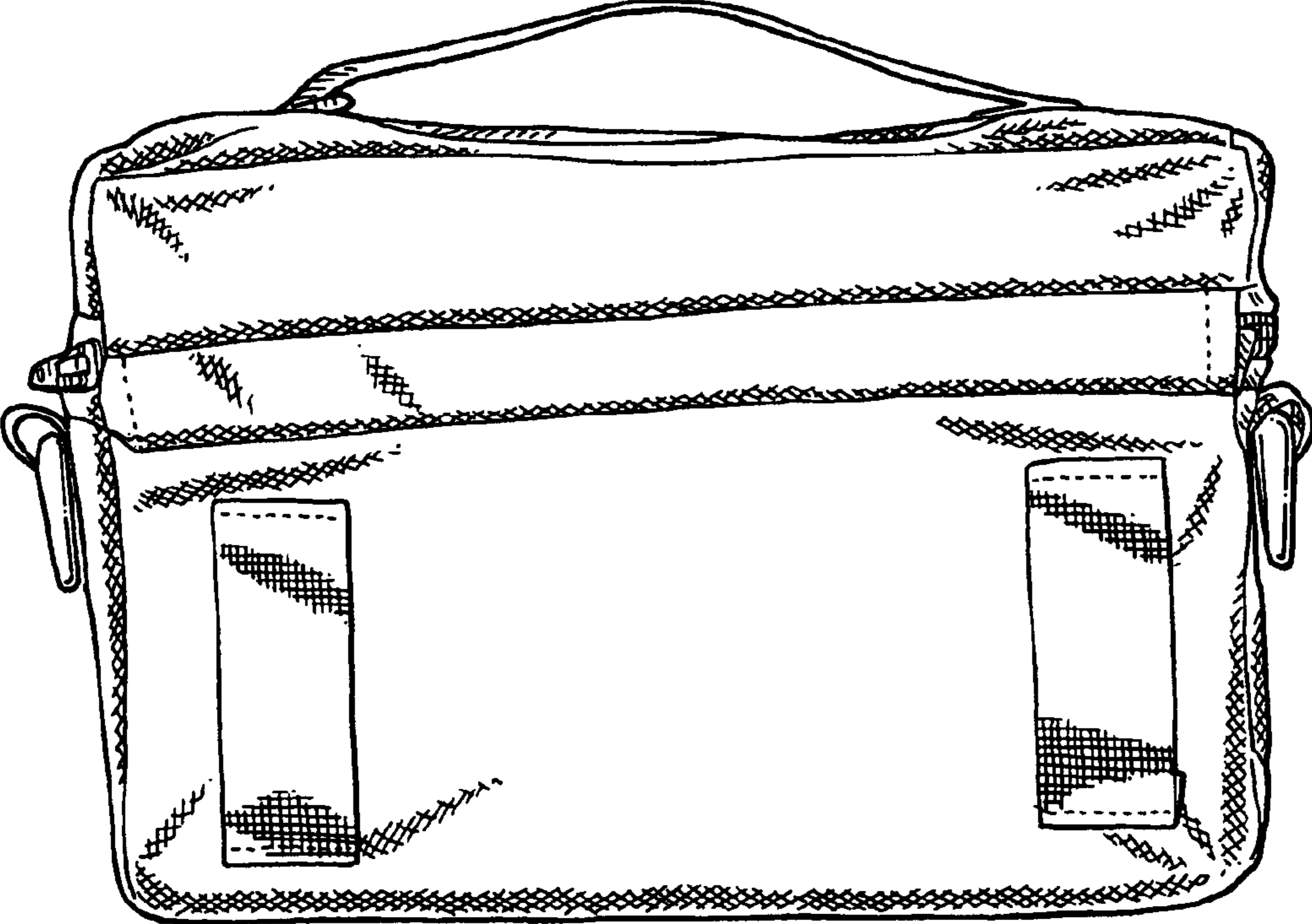

FIG. 2

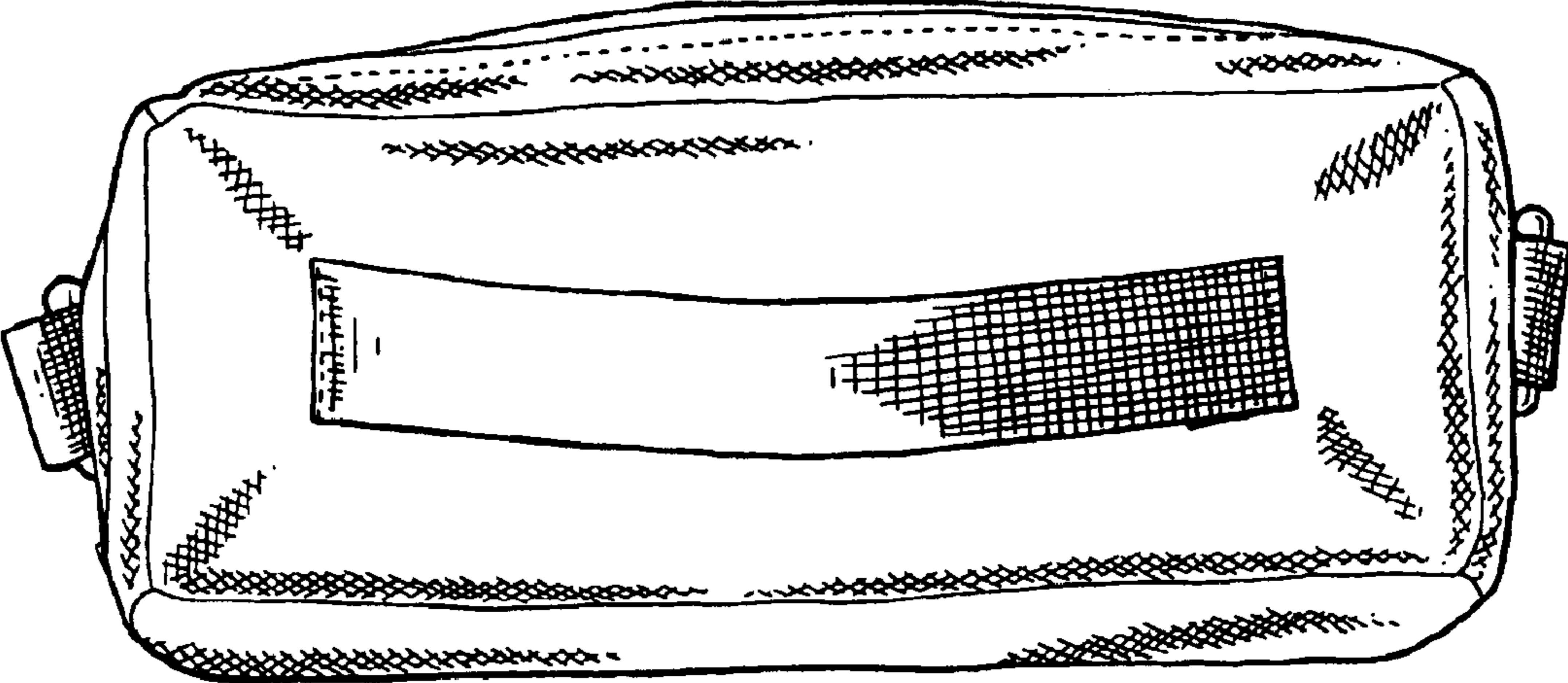

FIG. 3

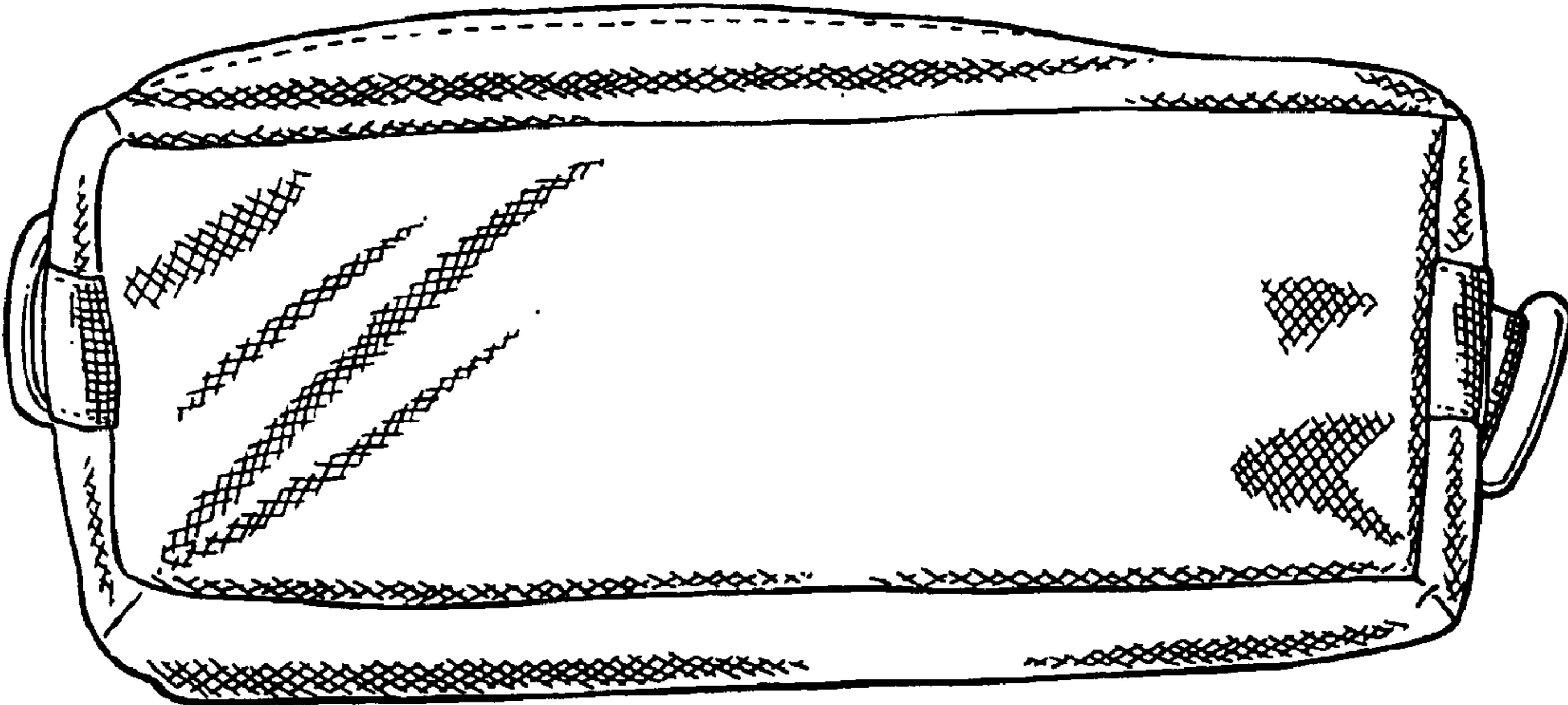

FIG. 4

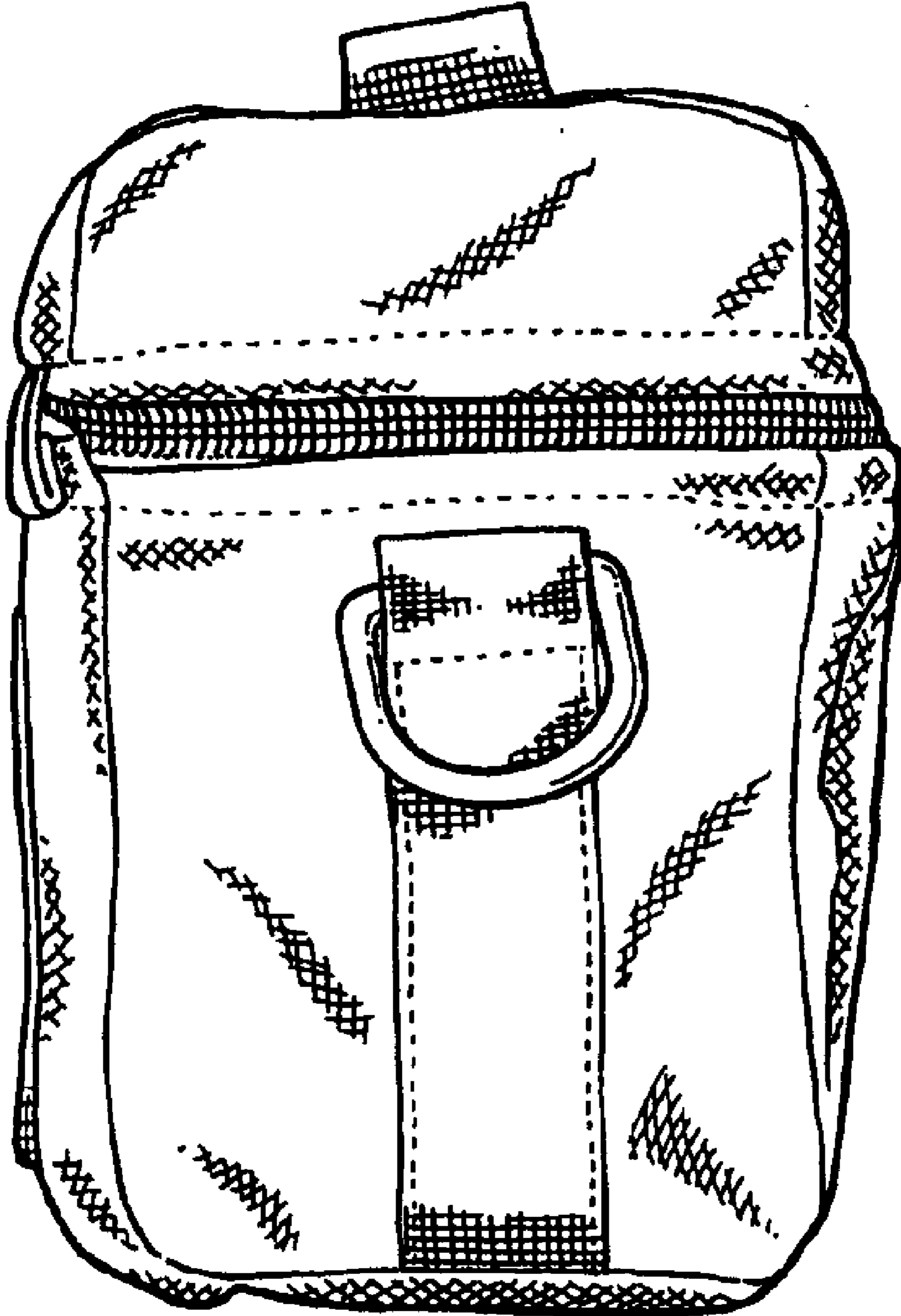

FIG. 5



FIG. 6