



US00D512238S

(12) **United States Design Patent**
Chen

(10) **Patent No.:** **US D512,238 S**
(45) **Date of Patent:** **** Dec. 6, 2005**

(54) **CHAIR**

(76) **Inventor:** **Su-Ming Chen**, PMB #1008, 1867
Ygnacio Valley Rd., Walnut Creek, CA
(US) 94598

(**) **Term:** **14 Years**

(21) **Appl. No.:** **29/201,037**

(22) **Filed:** **Mar. 10, 2004**

(51) **LOC (8) Cl.** **06-01**

(52) **U.S. Cl.** **D6/380; D6/379**

(58) **Field of Search** D6/334, 335, 369,
D6/371-374, 376, 379, 380, 500-502; 297/411.42,
445.1, 446.1

(56) **References Cited**

U.S. PATENT DOCUMENTS

D90,705 S	*	9/1933	Goodman	D6/371
D268,799 S	*	5/1983	Feldberg	D6/379
D302,495 S	*	8/1989	Hashihara	D6/379
D339,006 S	*	9/1993	Schneider	D6/379
D350,653 S	*	9/1994	Citterio	D6/372

D418,322 S	*	1/2000	Hock	D6/374
D449,938 S	*	11/2001	Vanderiet et al.	D6/380
D455,571 S	*	4/2002	Van De Riet et al.	D6/380
D456,164 S	*	4/2002	Vanderiet et al.	D6/374
D459,604 S	*	7/2002	Piretti	D6/380
D477,471 S	*	7/2003	Brooks	D6/379

* cited by examiner

Primary Examiner—Mimosa De

(74) *Attorney, Agent, or Firm*—Leong C. Lei

(57) **CLAIM**

The ornamental design for a chair, as shown and described.

DESCRIPTION

FIG. 1 is a perspective view of a chair showing my new design;

FIG. 2 is a front side elevation view thereof;

FIG. 3 is a rear side elevation view thereof;

FIG. 4 is a left side elevation view thereof;

FIG. 5 is a right side elevation view thereof;

FIG. 6 is a top plan view thereof; and,

FIG. 7 is a bottom plan view thereof.

1 Claim, 4 Drawing Sheets

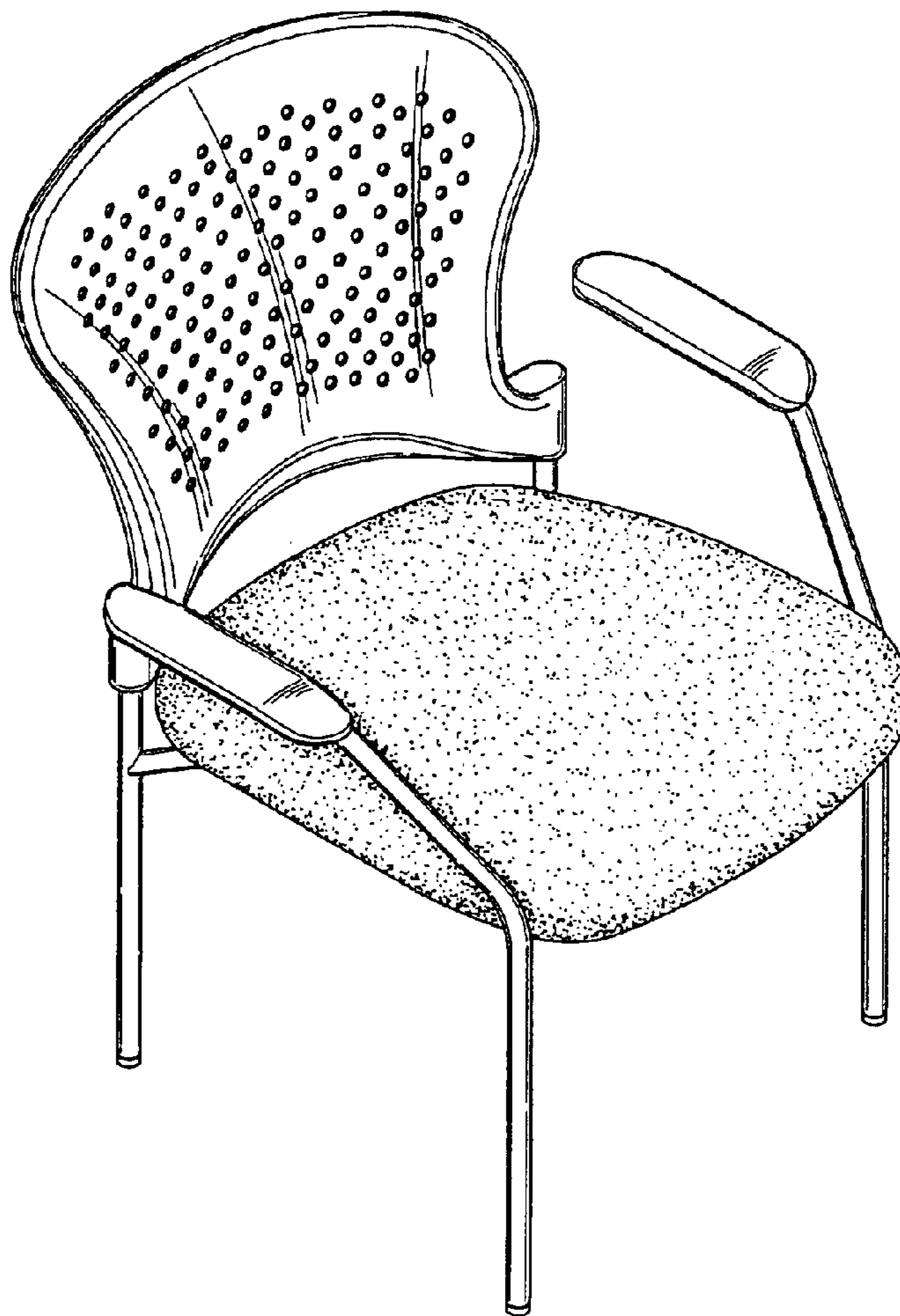

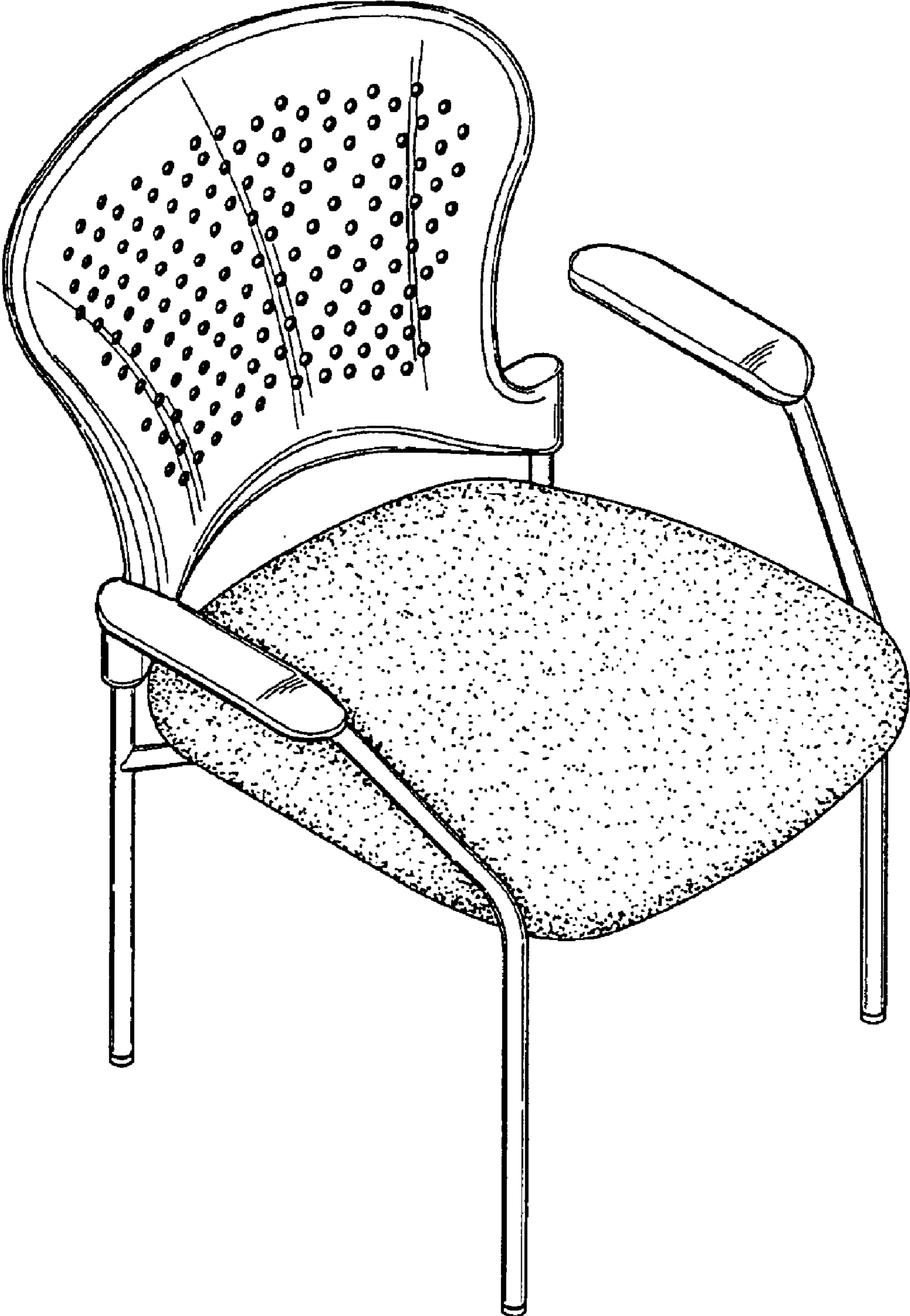

FIG. 1

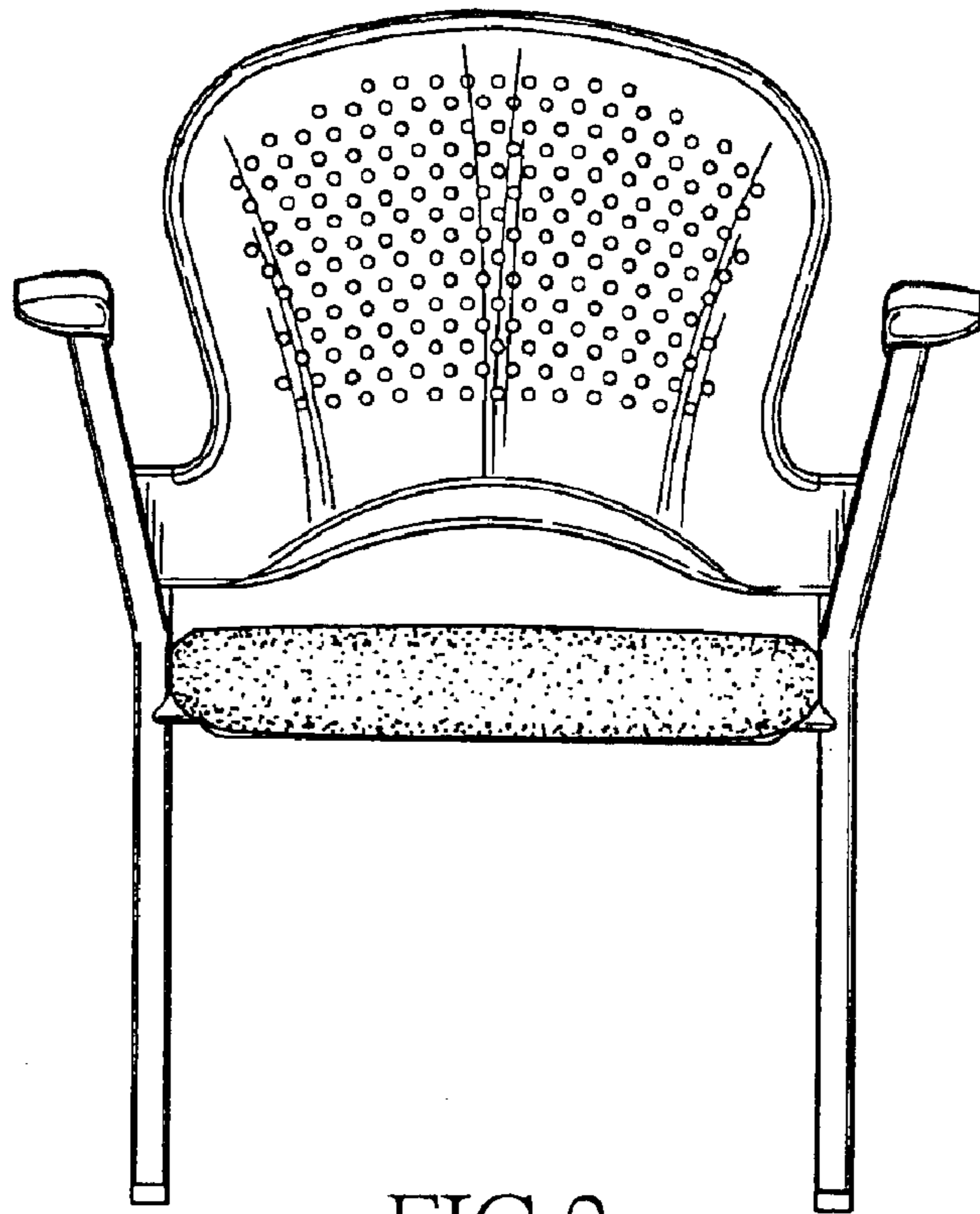

FIG. 2

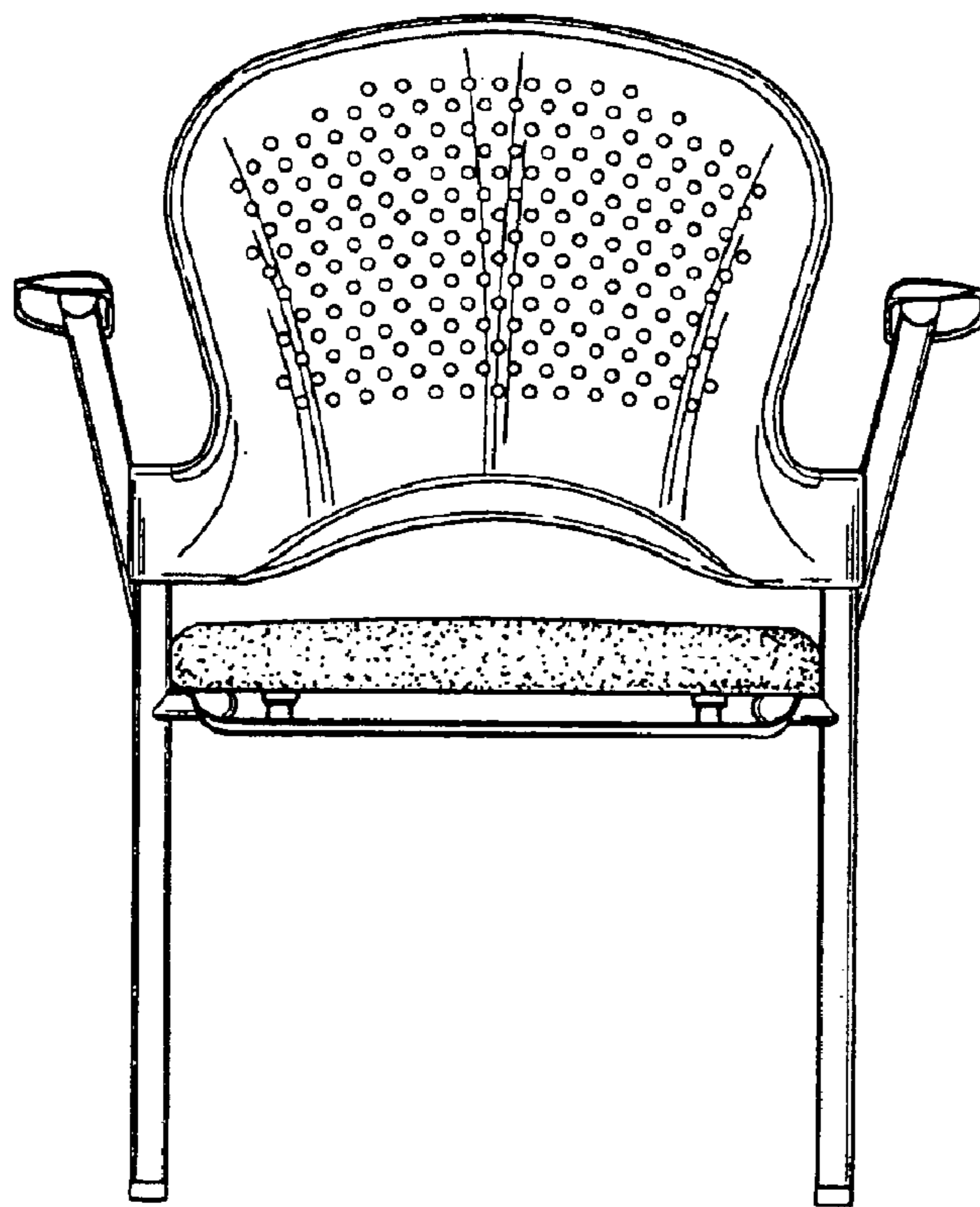

FIG. 3

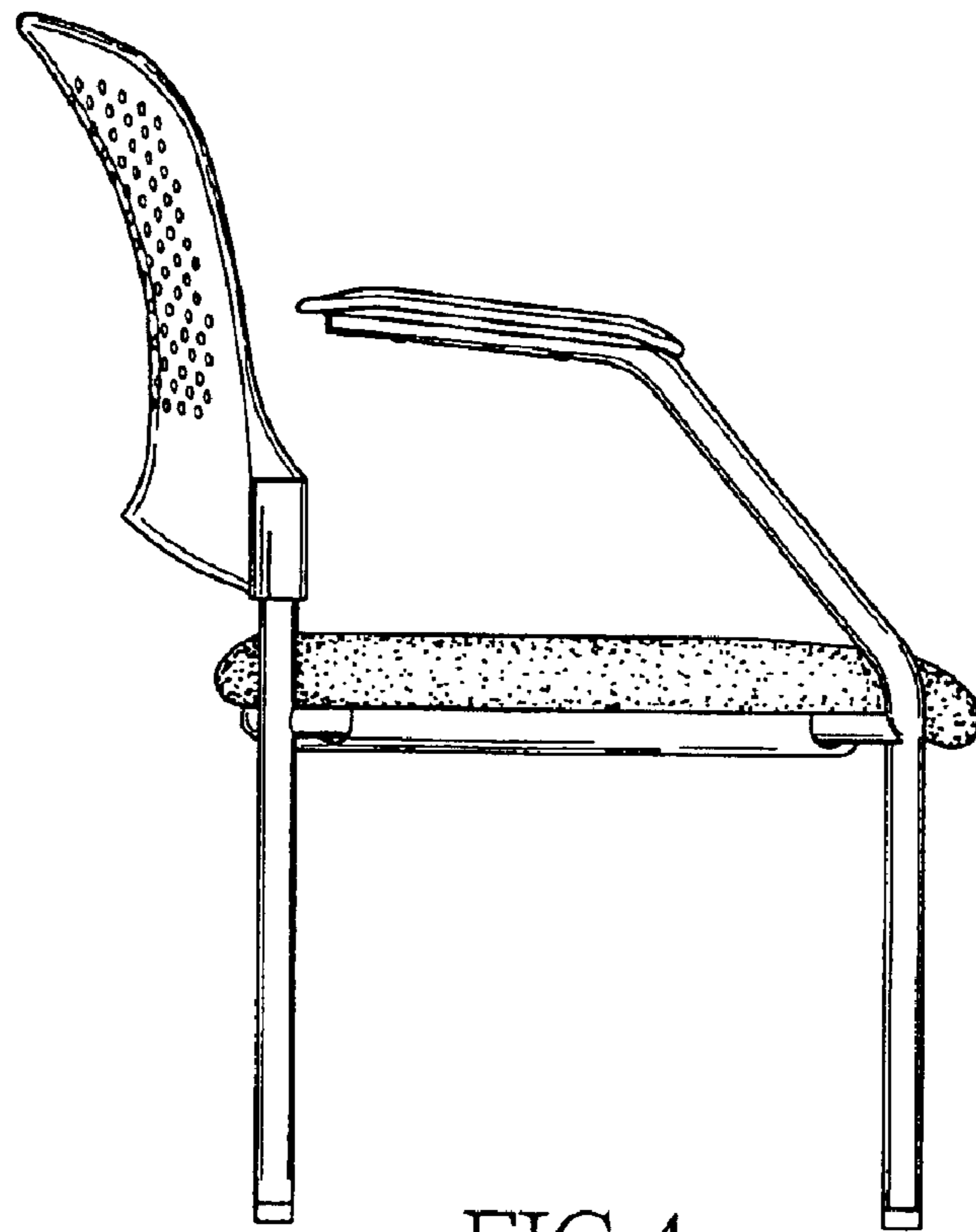

FIG. 4

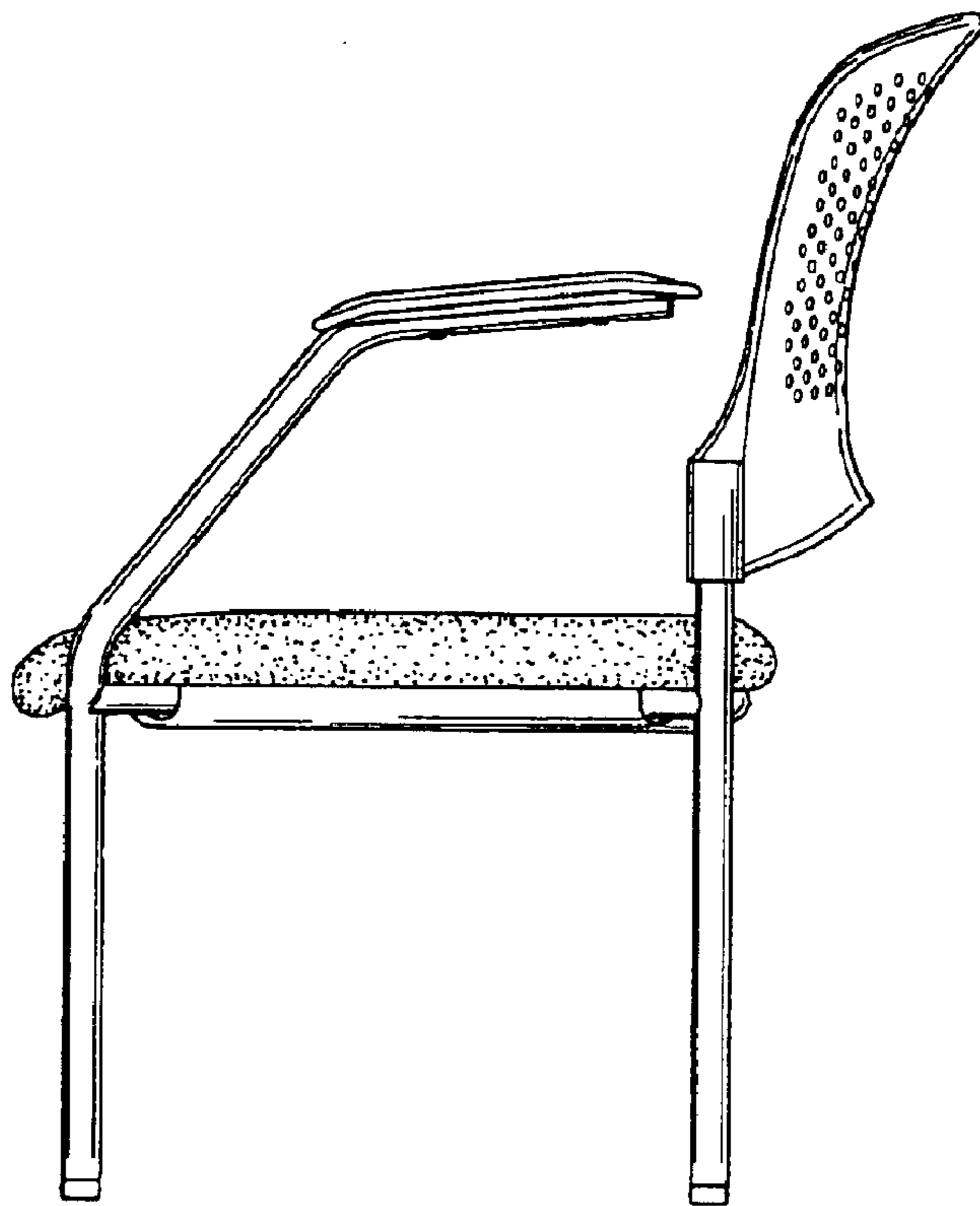

FIG. 5

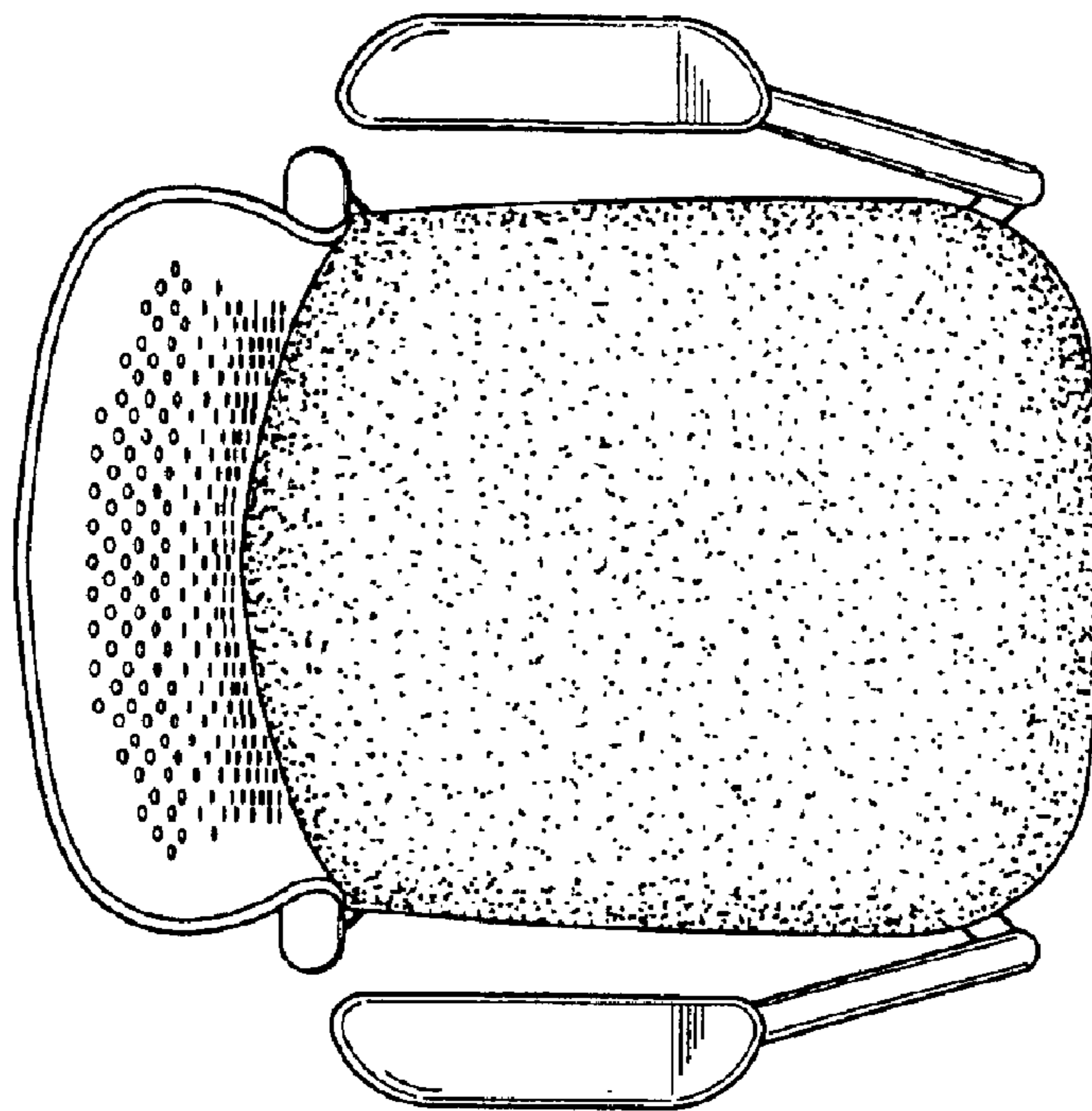

FIG. 6

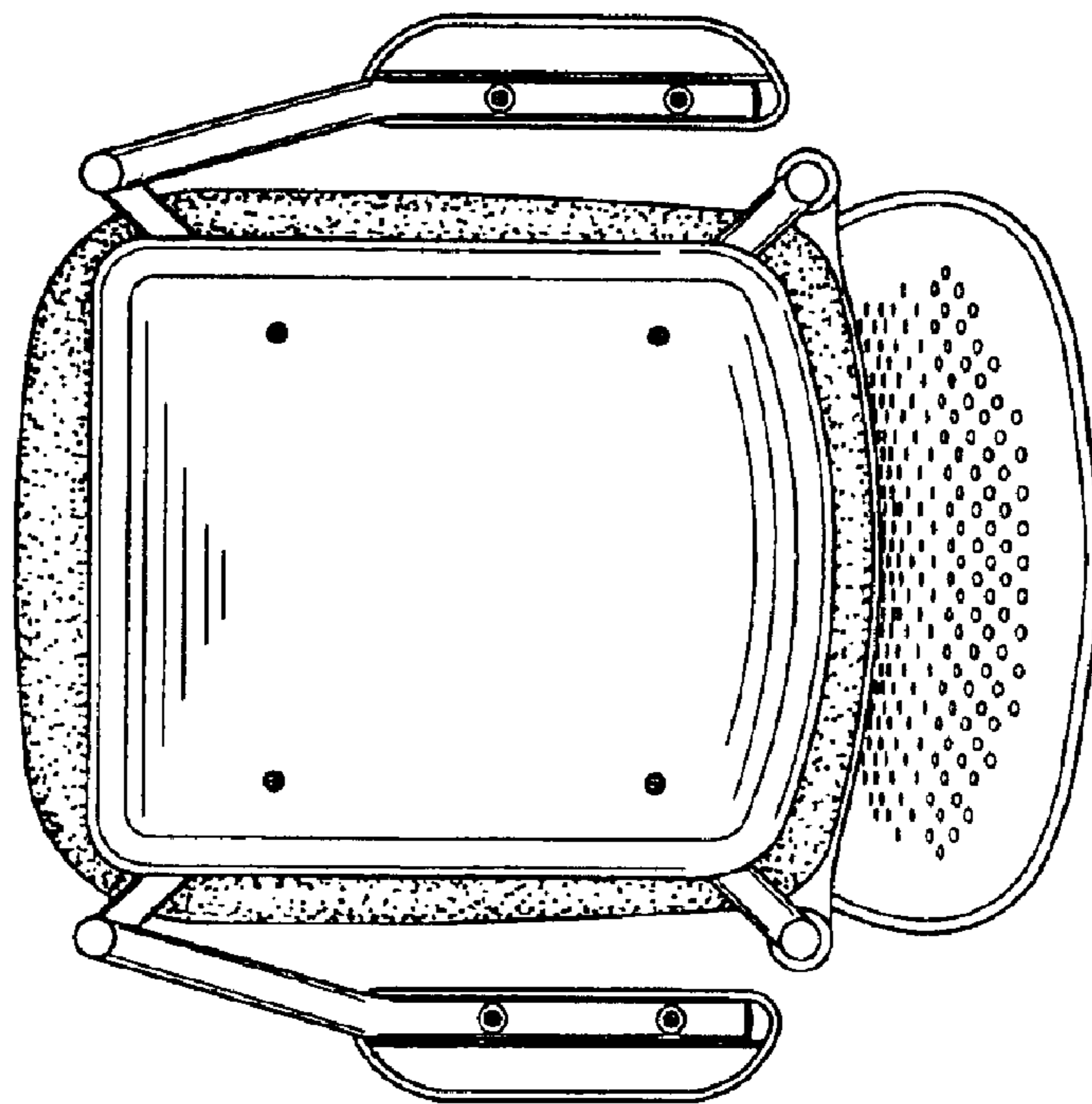

FIG. 7