



US00D512048S

(12) **United States Design Patent**
Borsboom

(10) **Patent No.:** **US D512,048 S**

(45) **Date of Patent:** **** Nov. 29, 2005**

(54) **PAIR OF SPEAKERS**

(75) Inventor: **Antonious M. Borsboom**, Singapore (SG)

(73) Assignee: **Hannspree, Inc.**, Taipei (TW)

(**) Term: **14 Years**

(21) Appl. No.: **29/199,587**

(22) Filed: **Feb. 18, 2004**

(51) **LOC (8) Cl.** **14-01**

(52) **U.S. Cl.** **D14/216**

(58) **Field of Search** D14/204, 207,
D14/209-216, 356; 181/143-144, 147-148,
150, 157, 198-199, 151, 153; 381/300-302,
306, 333, 345, 361-364, 386-388, 332,
336

(56) **References Cited**

U.S. PATENT DOCUMENTS

D186,892 S	*	12/1959	Wilber	D14/211
3,908,790 A	*	9/1975	Phelps et al.	181/198
D349,704 S	*	8/1994	Tsing	D14/216
D419,560 S	*	1/2000	Cheung	D14/216
D447,471 S	*	9/2001	Andre et al.	D14/216
D462,068 S	*	8/2002	Solland	D14/216

* cited by examiner

Primary Examiner—Nanda Bondade

(74) *Attorney, Agent, or Firm*—Thomas, Kayden, Horstemeyer & Risley

(57) **CLAIM**

The ornamental design for pair of speakers, as shown and described.

DESCRIPTION

FIG. 1 is a front perspective view of a pair of speakers showing my new design;

FIG. 2 is a front elevational view thereof;

FIG. 3 is a rear elevational view thereof;

FIG. 4 is a left side elevational view thereof;

FIG. 5 is a right side elevational view thereof;

FIG. 6 is a top plane view thereof;

FIG. 7 is a bottom plane view thereof;

FIG. 8 is a front perspective view of the second embodiment of FIG. 1;

FIG. 9 is a front elevational view thereof;

FIG. 10 is a rear elevational view thereof;

FIG. 11 is a left side elevational view thereof;

FIG. 12 is a right side elevational view thereof;

FIG. 13 is a top plane view thereof; and,

FIG. 14 is a bottom plane view thereof.

1 Claim, 14 Drawing Sheets

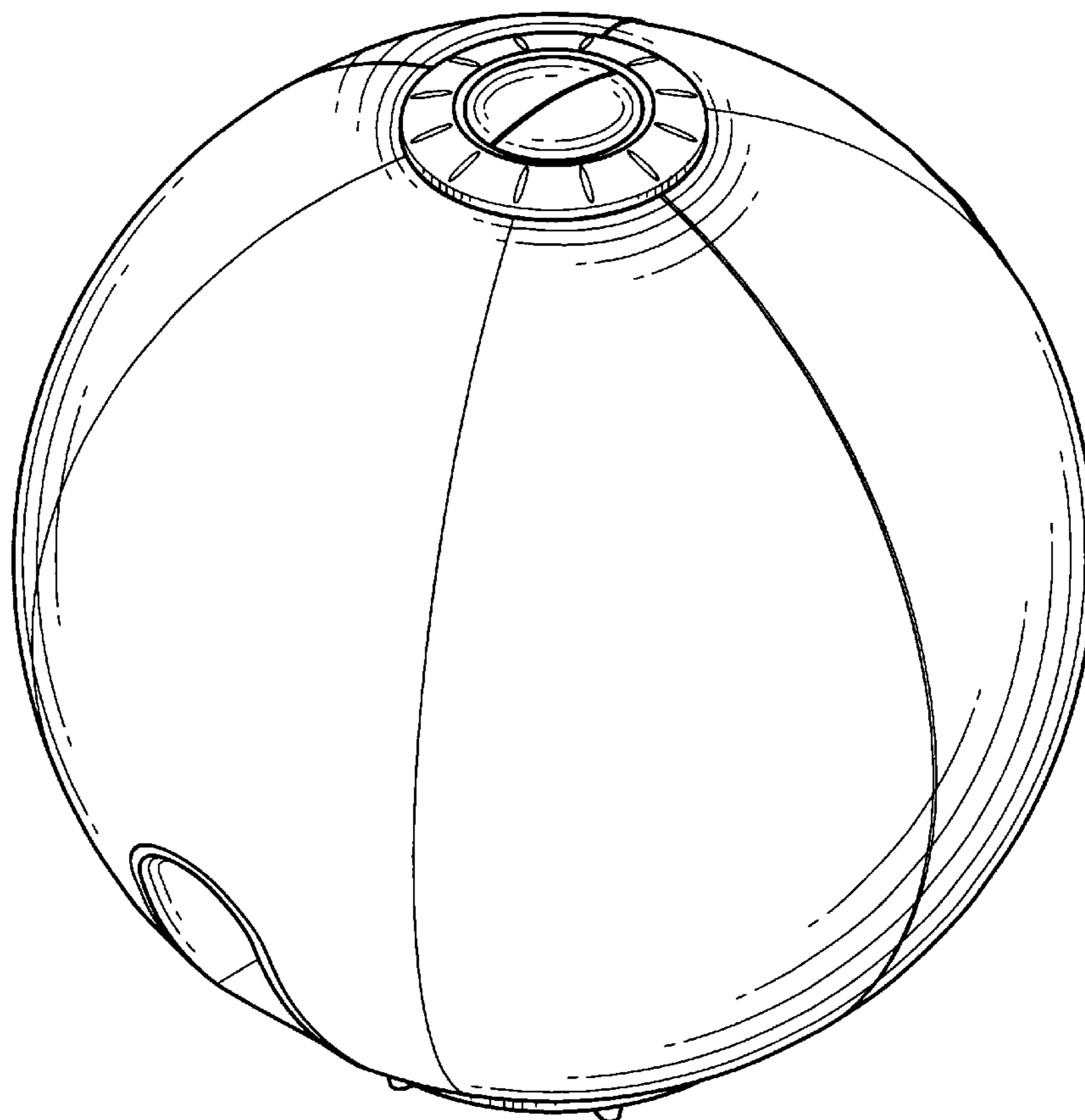

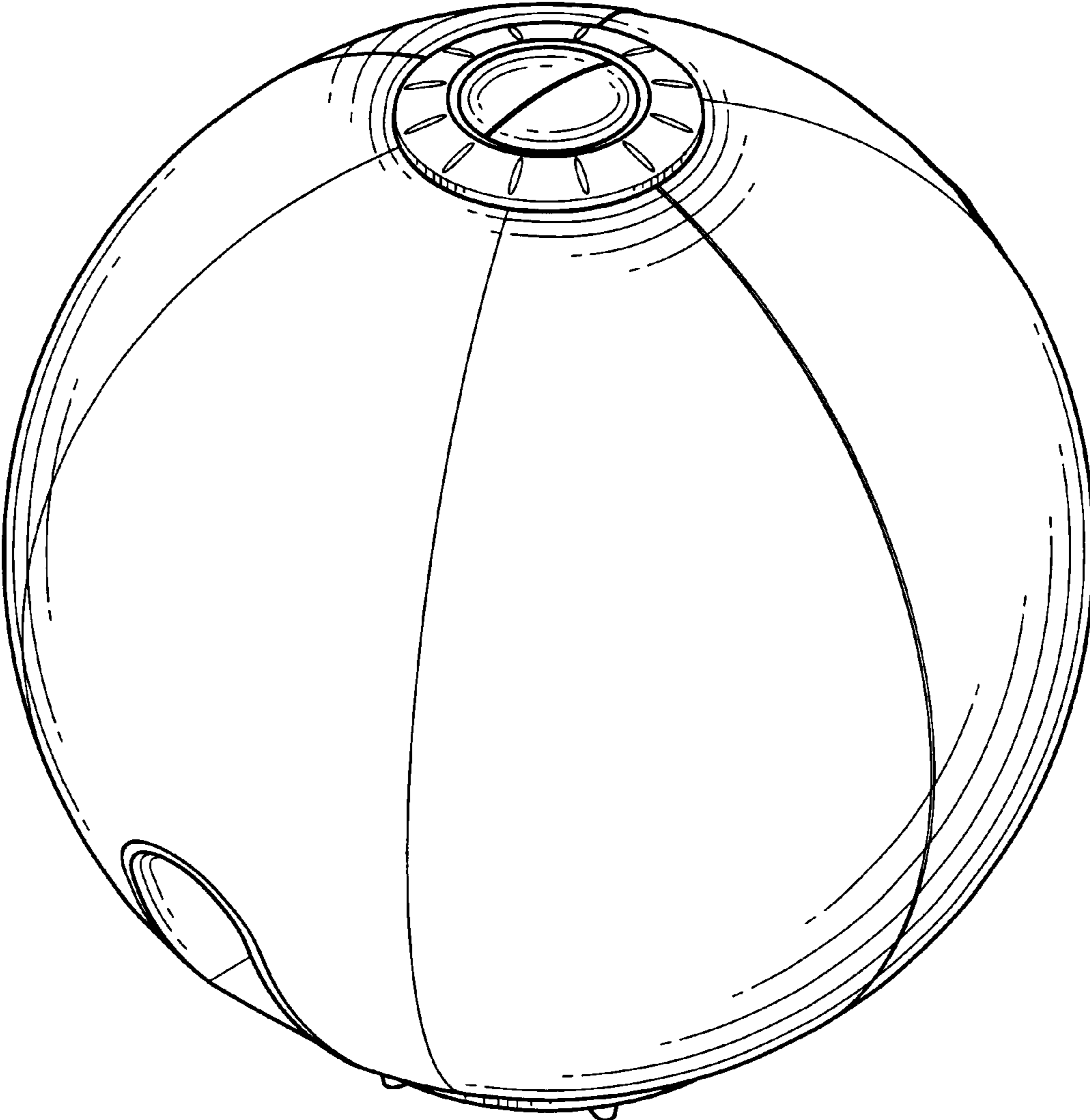

FIG. 1

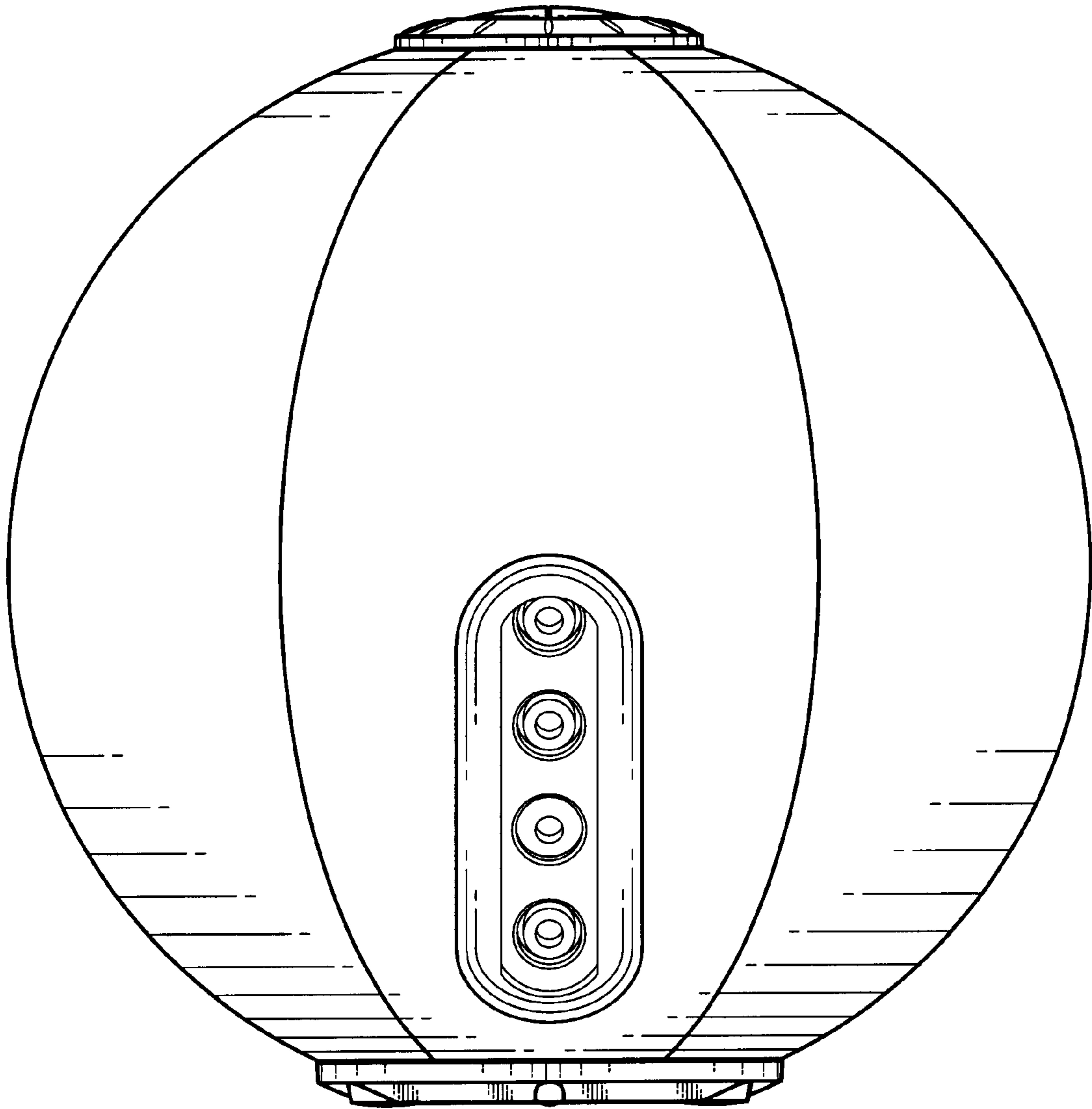

FIG. 2

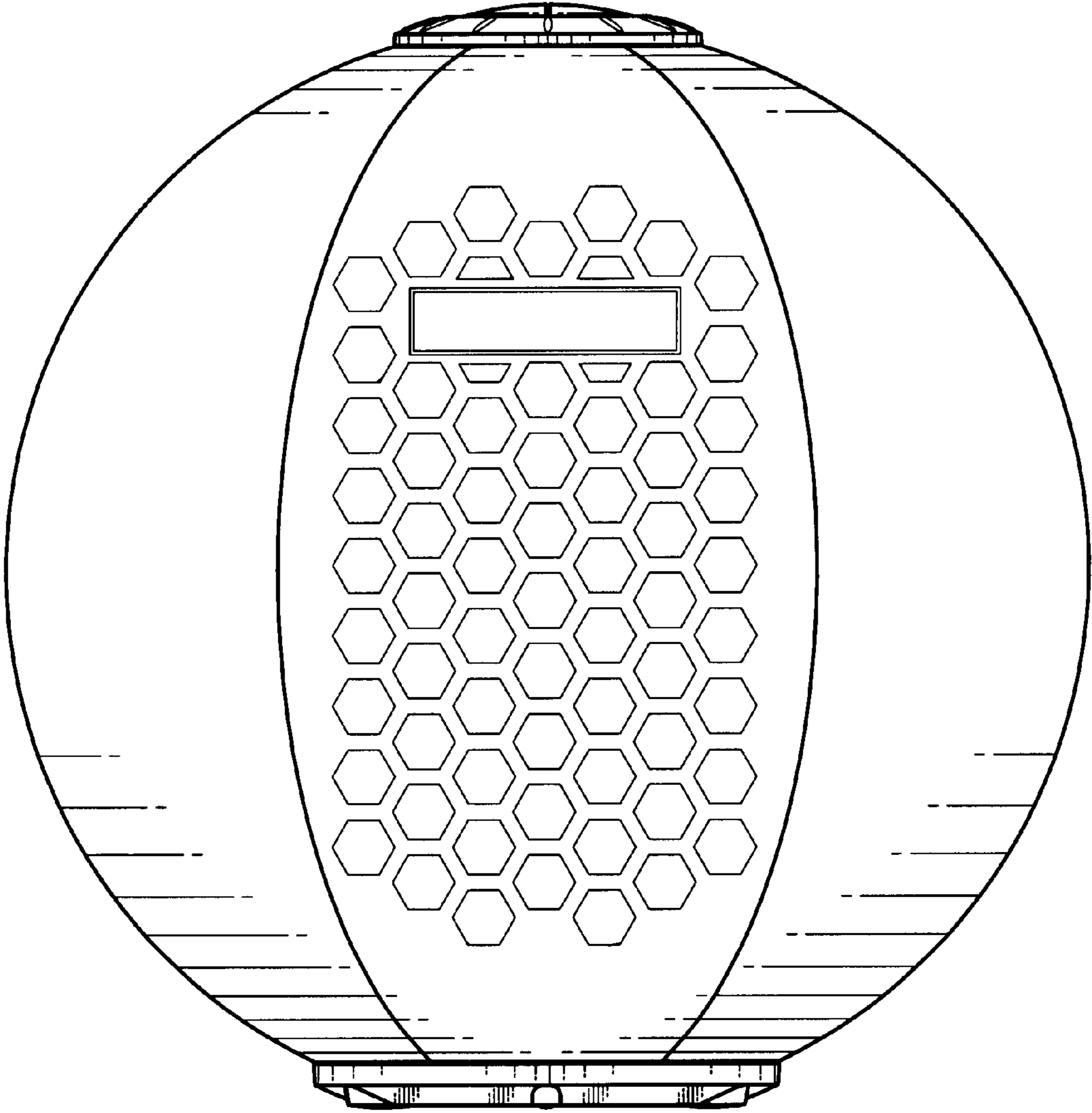

FIG. 3

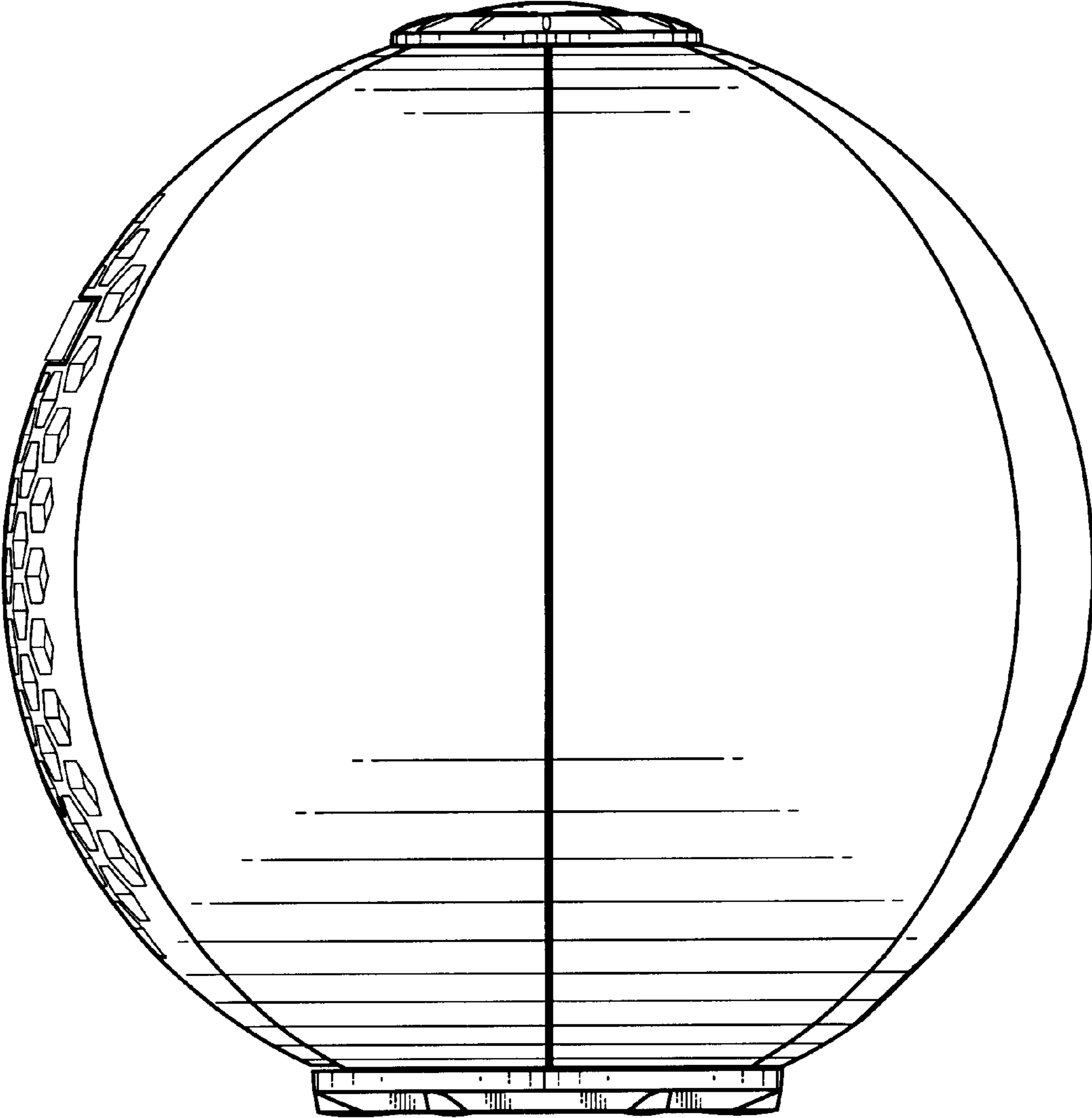

FIG. 4

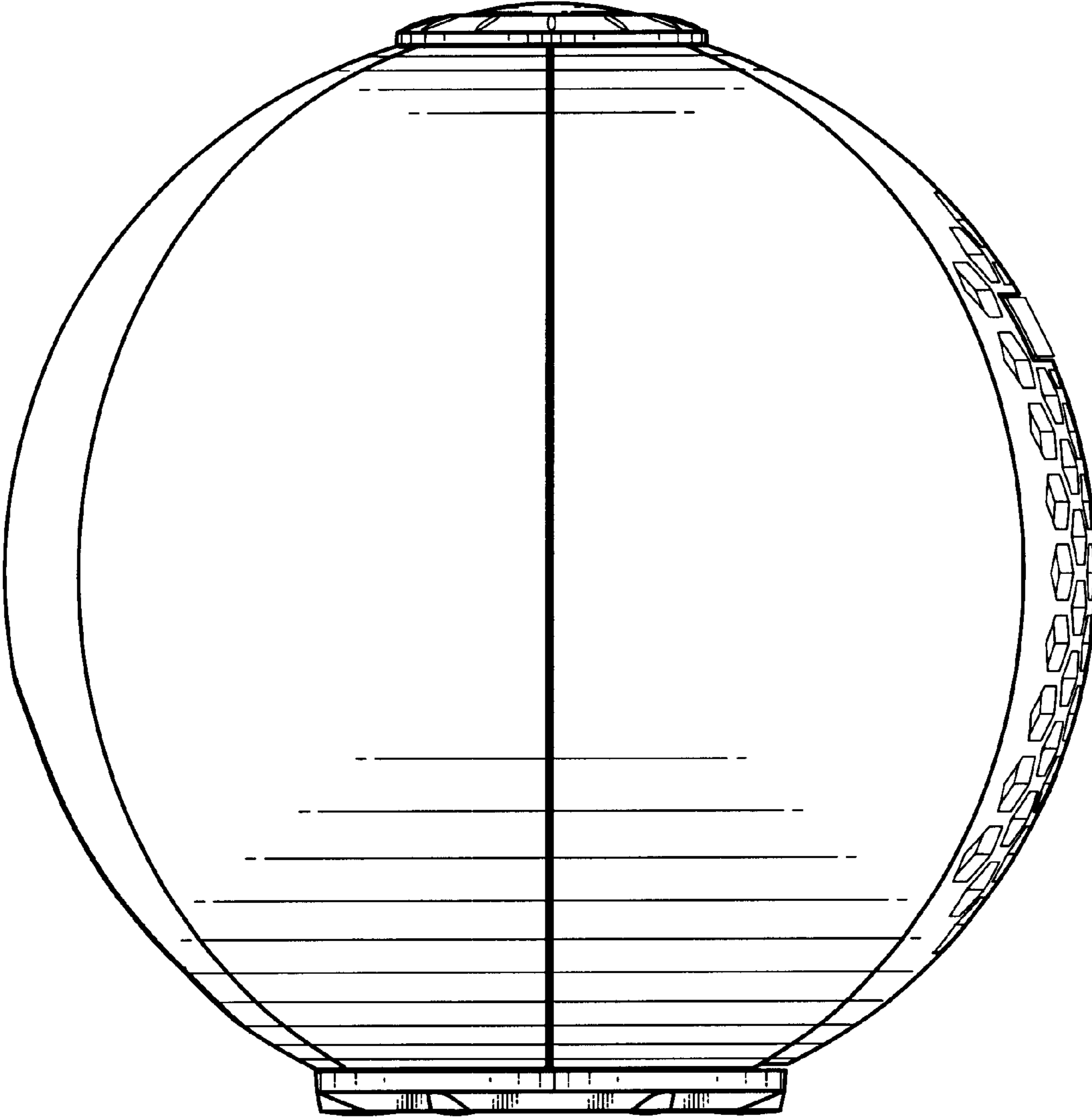

FIG. 5

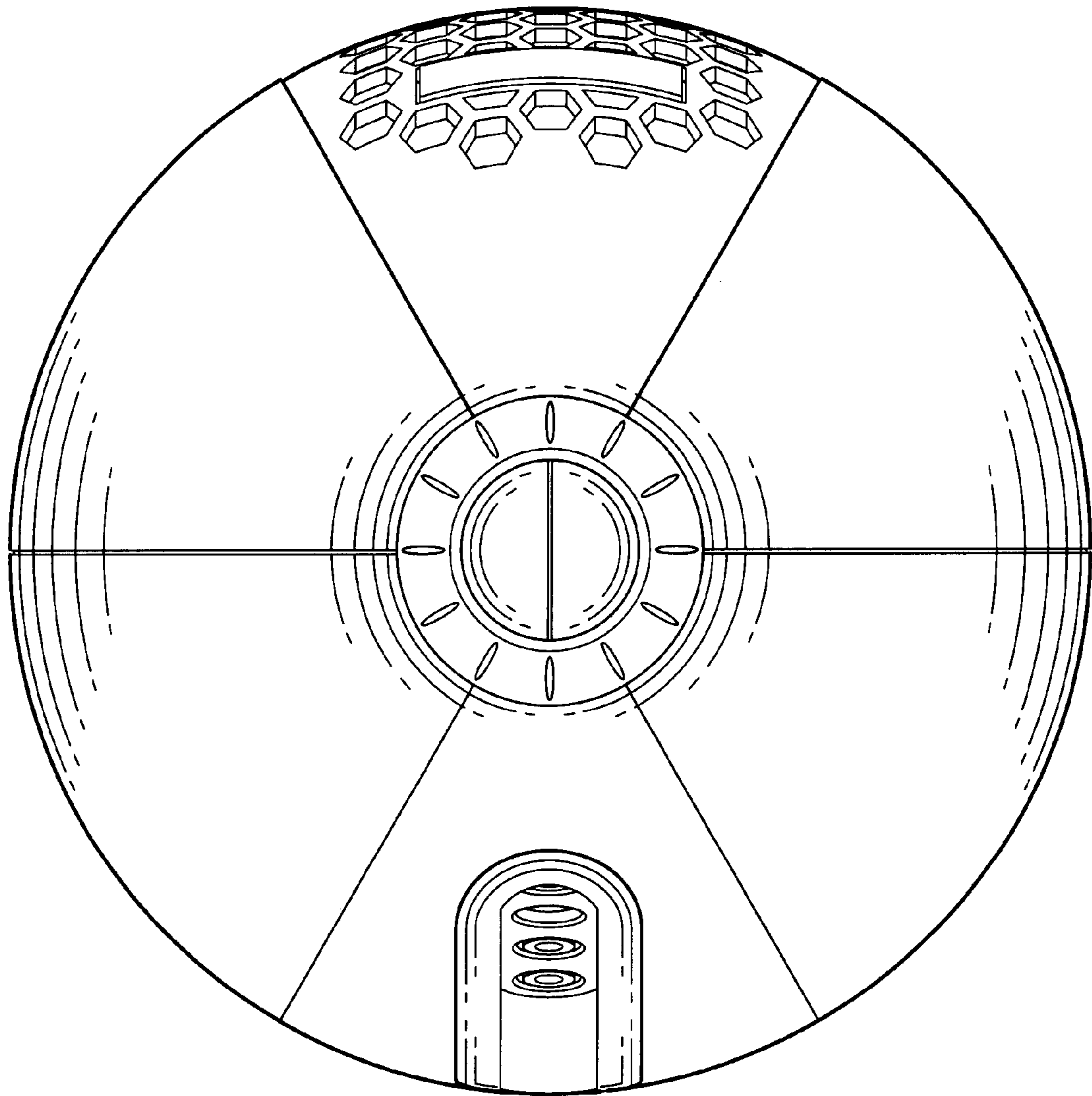

FIG. 6

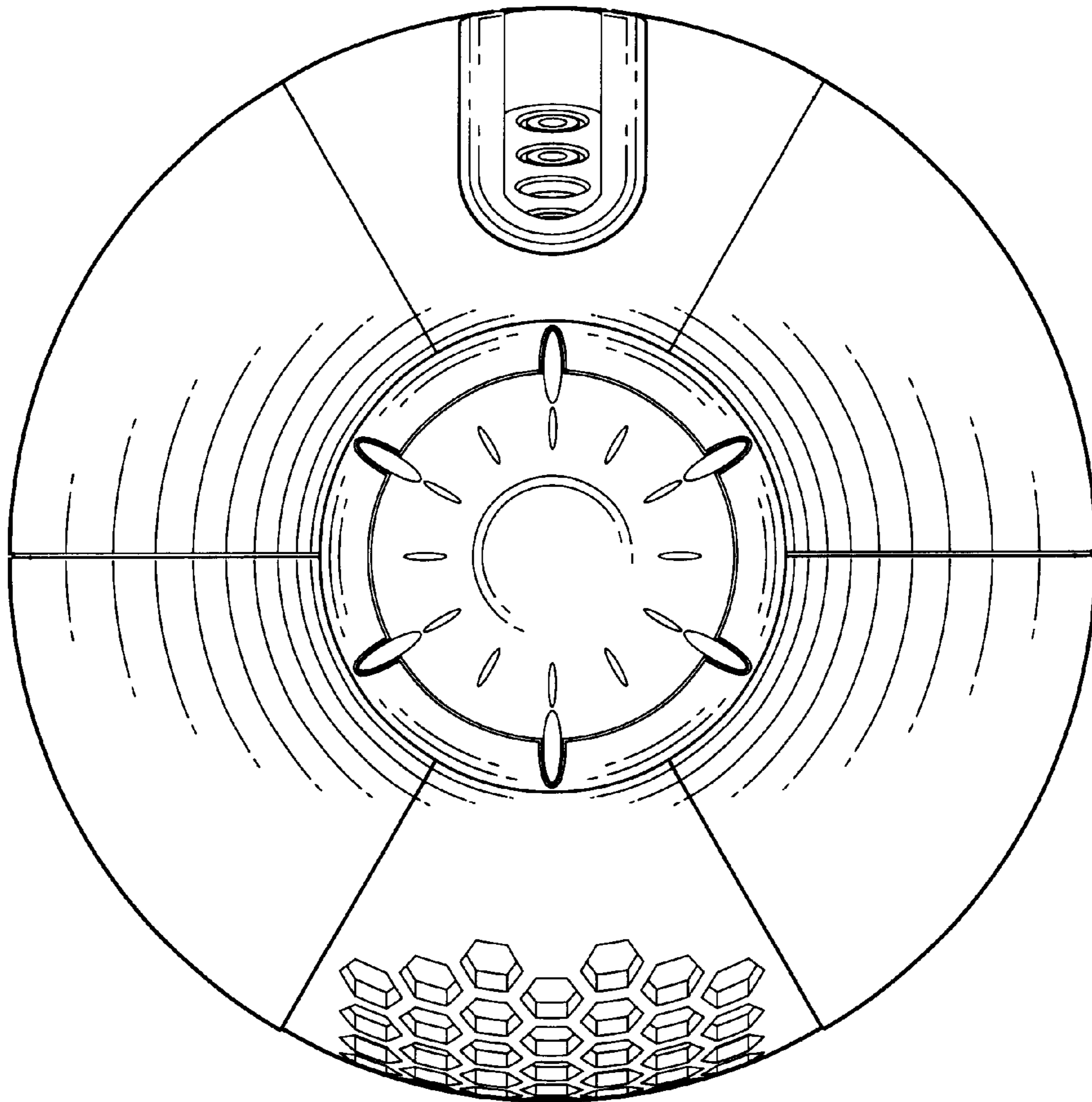

FIG. 7

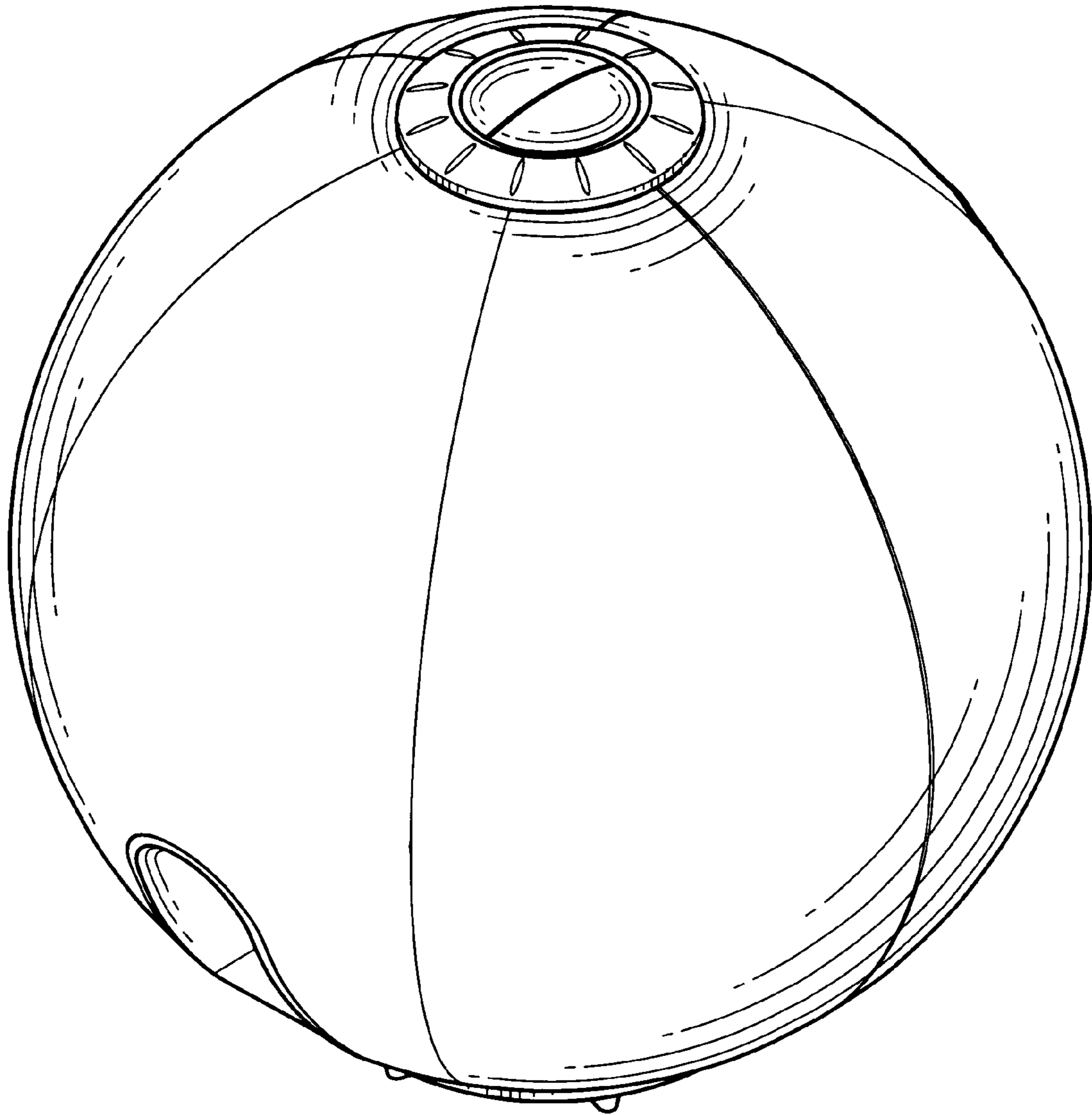

FIG. 8

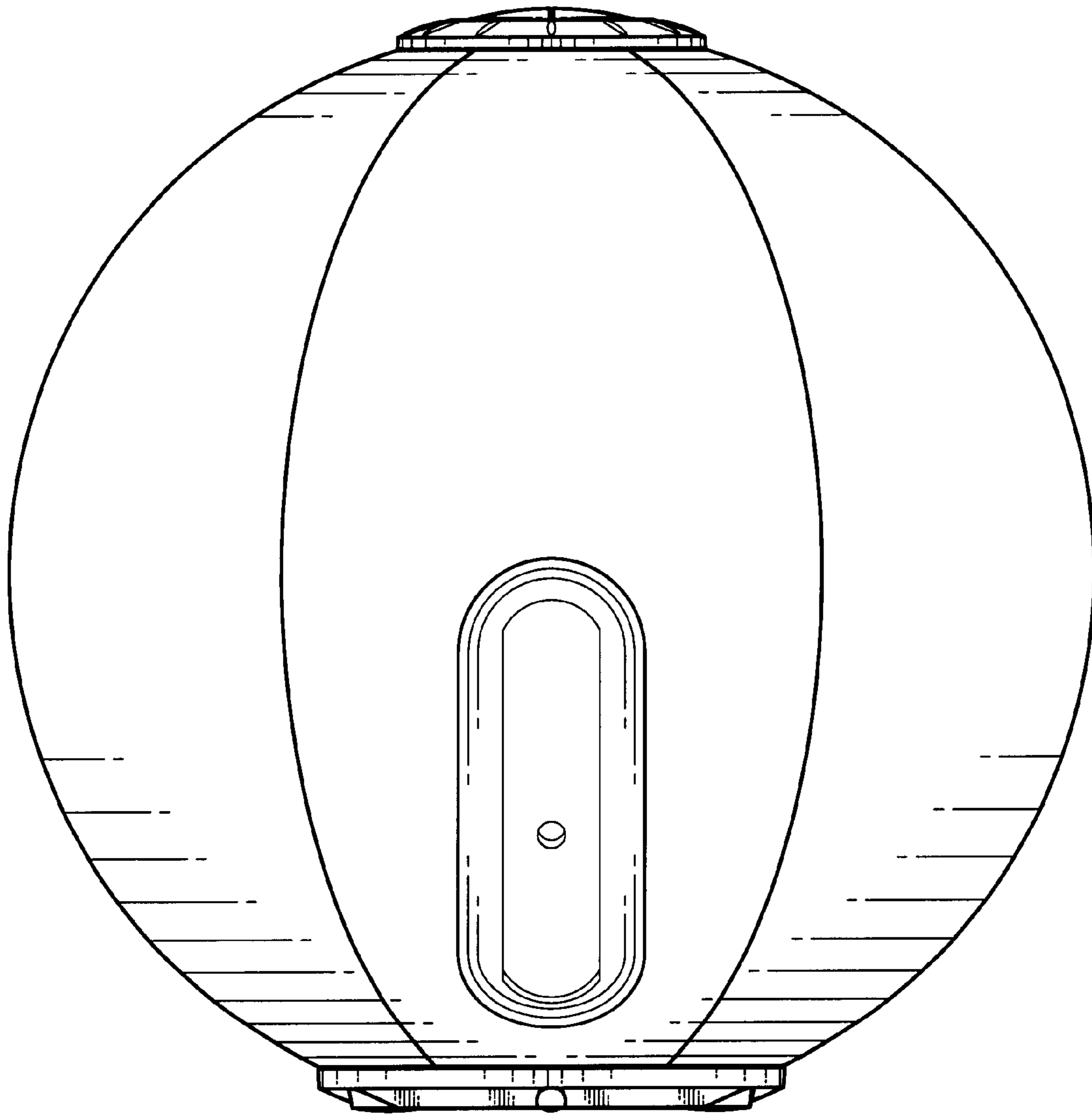

FIG. 9

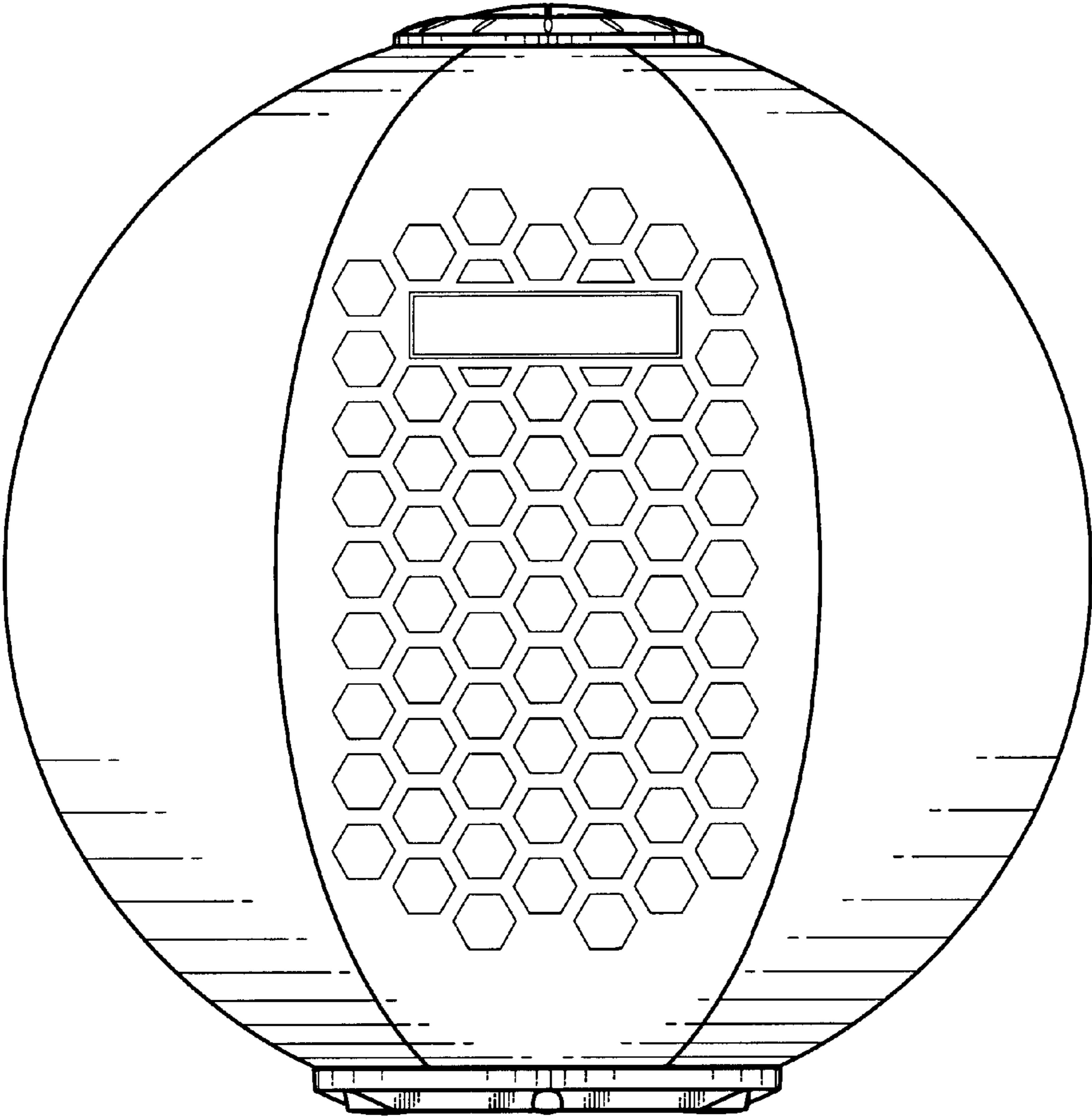

FIG. 10

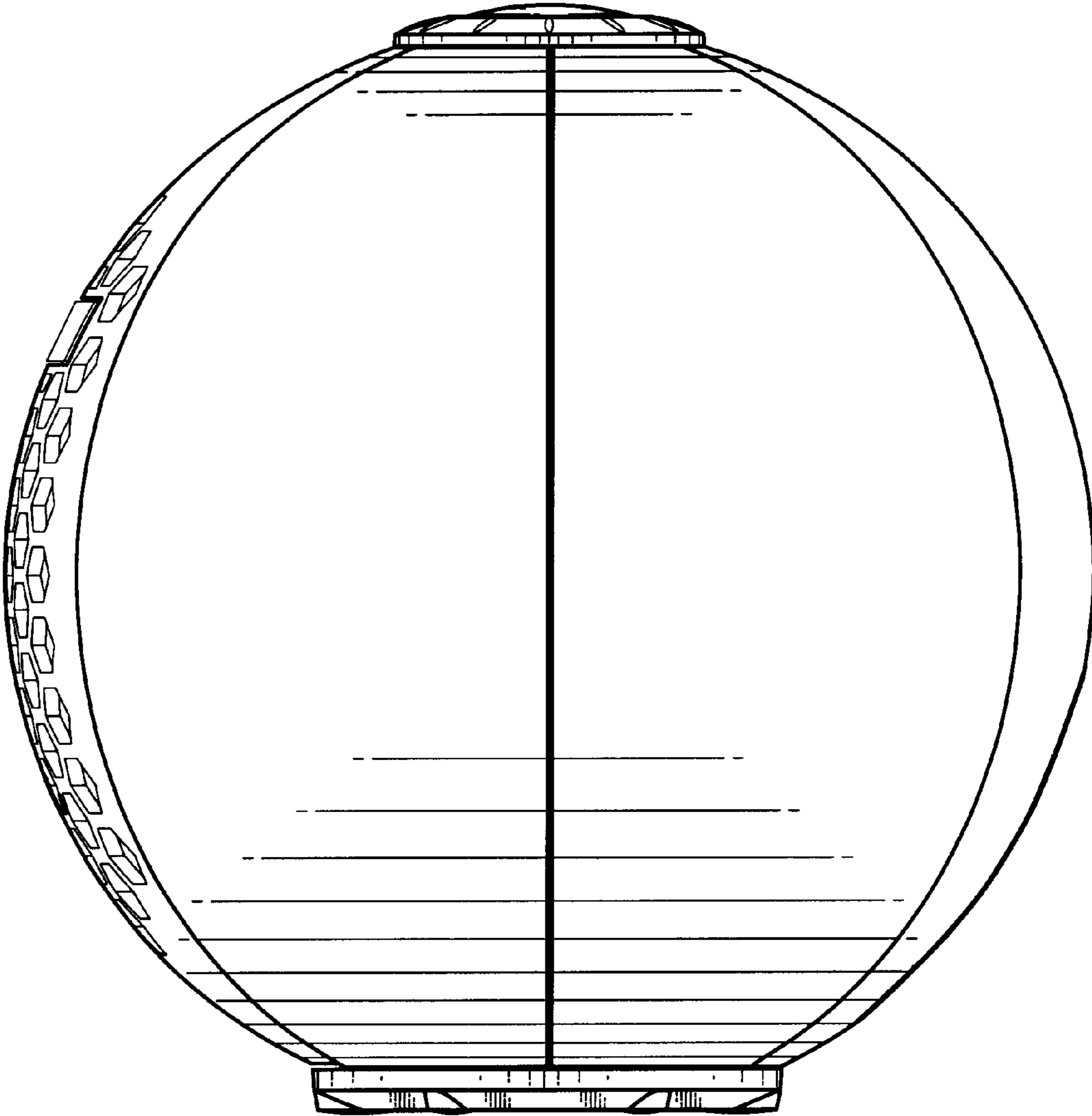

FIG. 11

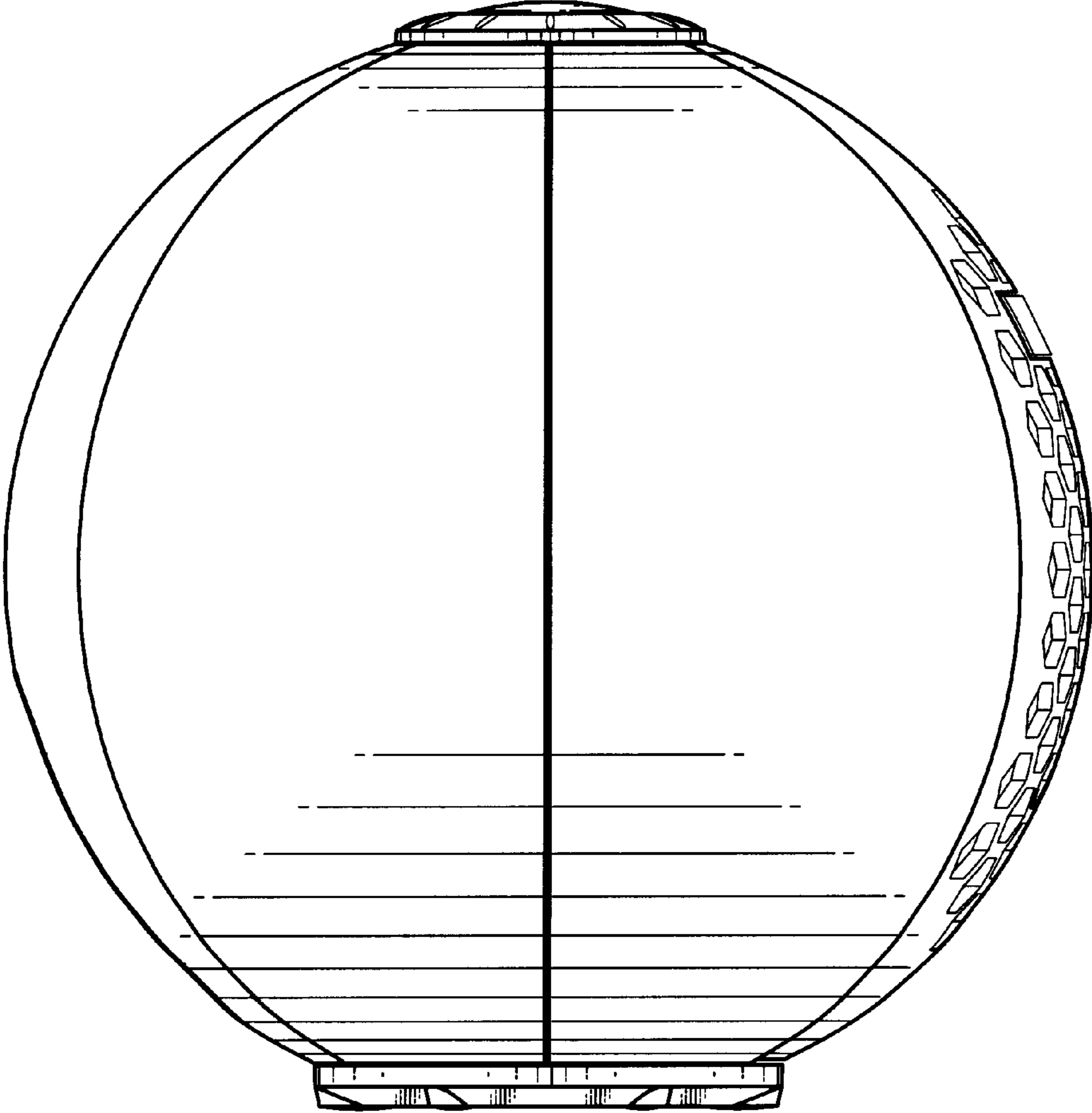

FIG. 12

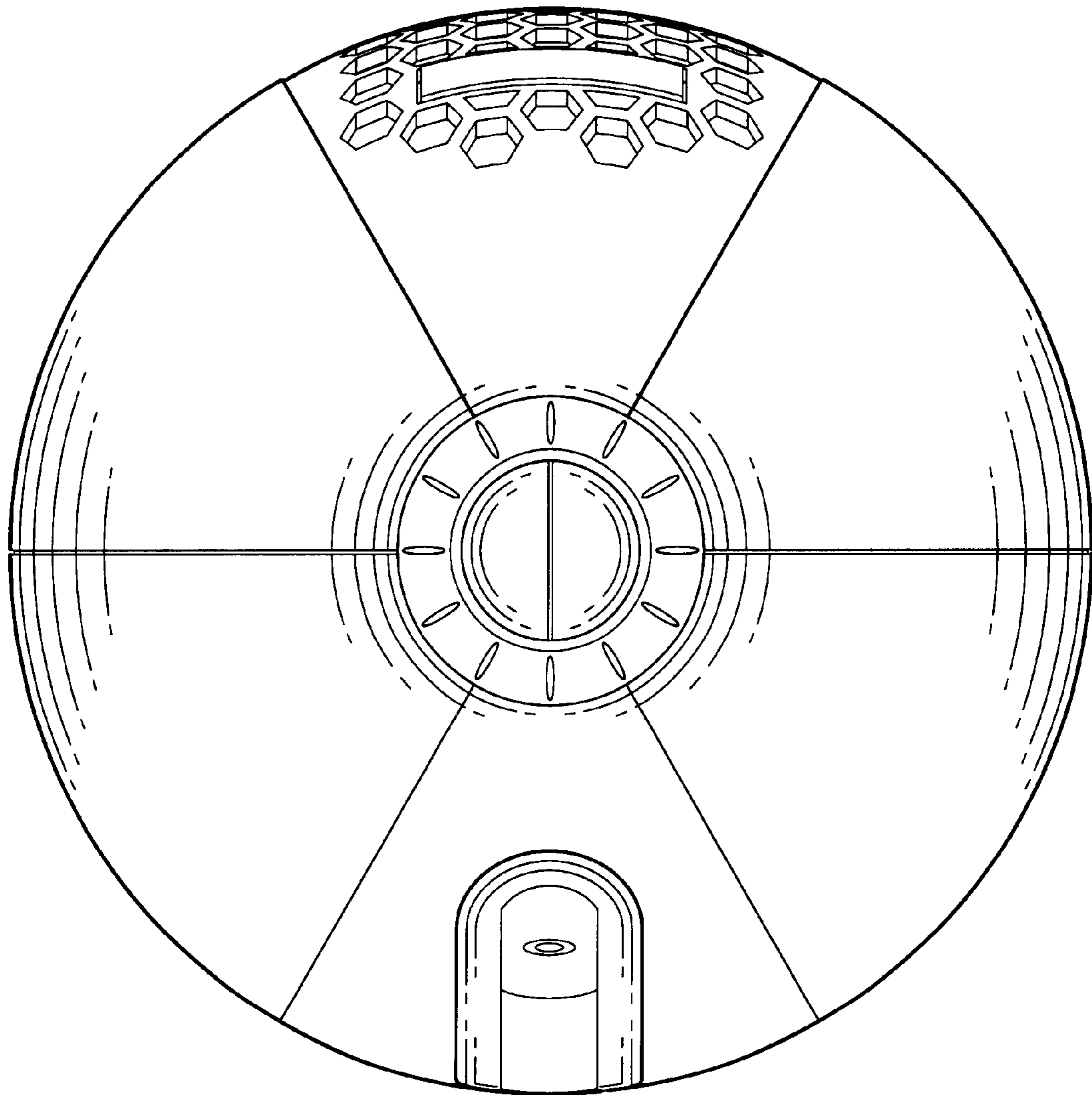

FIG. 13

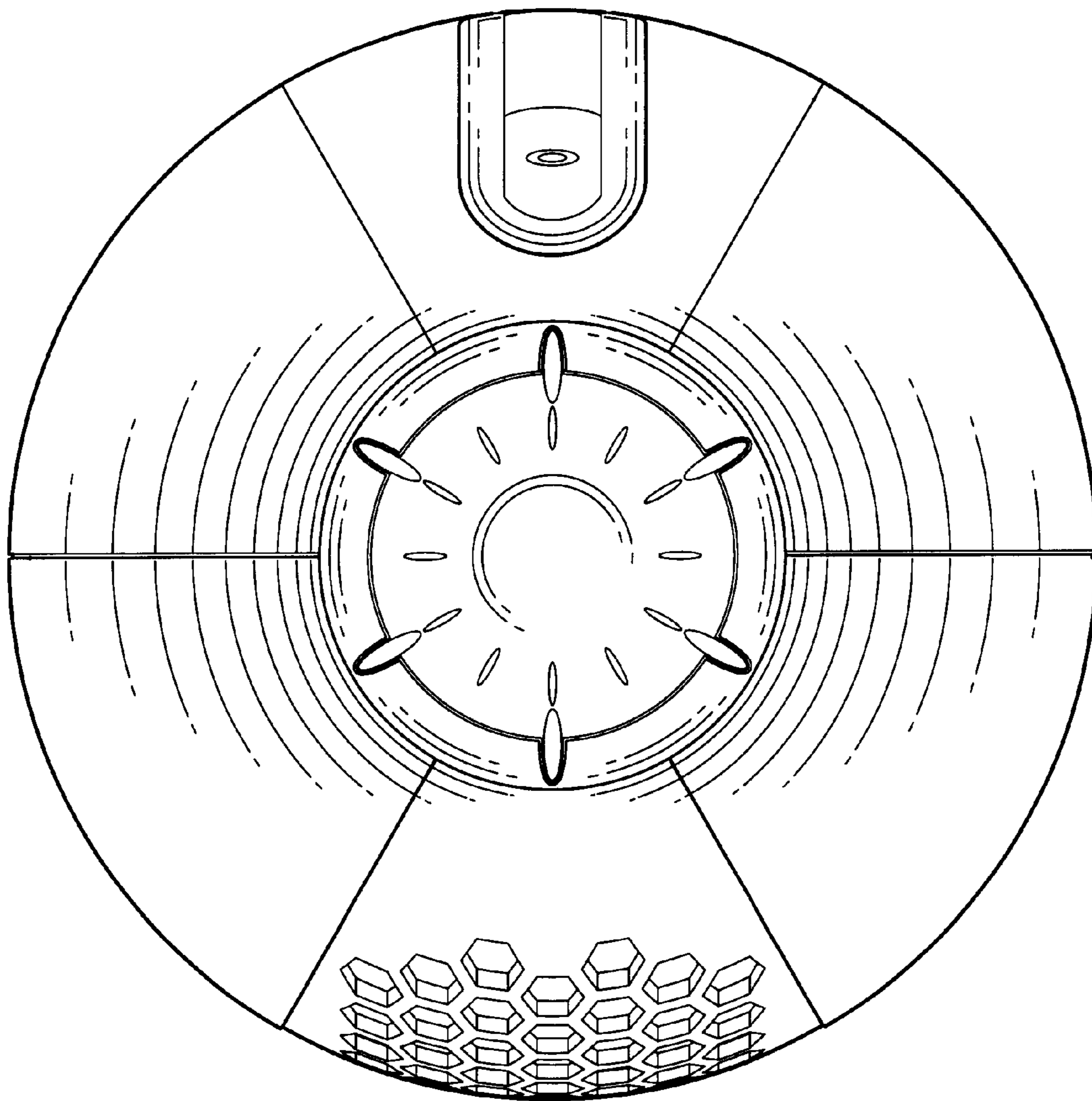

FIG. 14