



US00D511974S

(12) **United States Design Patent** (10) **Patent No.:** **US D511,974 S**  
**Petek** (45) **Date of Patent:** **\*\* Nov. 29, 2005**

- (54) **CONTAINER FOR AEROSOL CANS**
- (75) **Inventor:** **Josef Petek**, Flawil (CH)
- (73) **Assignee:** **E+H Services AG**, Daeniken (CH)
- (\*\*) **Term:** **14 Years**
- (21) **Appl. No.:** **29/188,012**
- (22) **Filed:** **Aug. 11, 2003**
- (51) **LOC (8) Cl.** ..... **09-01**
- (52) **U.S. Cl.** ..... **D9/682**
- (58) **Field of Search** ..... D9/682, 685, 686,  
D9/692, 694, 447, 448, 9, 505, 554, 8,  
258, 300, 449; D24/110, 115, 91.1, 76;  
D28/82, 91.1; 222/321.1, 321.2, 321.6,  
321.9, 372, 394, 405, 200.12-14, 213, 384;  
128/200.22; 384/153; D8/88; D23/213;  
D29/505, 544, 682, 685-6, 689, 693; 239/331,  
579, 333; 401/122

- 5,875,936 A \* 3/1999 Turbett et al. .... 222/207
- D418,404 S \* 1/2000 Irwin et al. .... D9/685
- D445,670 S \* 7/2001 De Baschmakoff ..... D9/682
- D445,685 S \* 7/2001 De Baschmakoff ..... D9/448
- 6,439,432 B1 \* 8/2002 Park ..... 222/113
- D471,973 S \* 3/2003 Gillissen et al. .... D24/110
- D473,640 S \* 4/2003 Cuffaro et al. .... D24/110
- D480,806 S \* 10/2003 Engelbreth et al. .... D24/110.5
- D481,305 S \* 10/2003 Walters et al. .... D9/685
- 6,726,016 B2 \* 4/2004 Chen ..... 206/581

\* cited by examiner

*Primary Examiner*—Phabhakar Deshmukh  
*Assistant Examiner*—Jean E. McCormick  
(74) *Attorney, Agent, or Firm*—Knobbe, Martens, Olson & Bear, LLP

(57) **CLAIM**

The ornamental designs for container for aerosol cans, as shown and described.

**DESCRIPTION**

FIG. 1 is a left side view of a container for aerosol cans;  
FIG. 2 is a front view thereof;  
FIG. 3 is a bottom view thereof;  
FIG. 4 is a top view thereof;  
FIG. 5 is an elevated perspective view thereof;  
FIG. 6 is an elevated rear perspective view thereof;  
FIG. 7 is a right side view thereof;  
FIG. 8 is a rear view thereof;  
FIG. 9 is a left side view of a second embodiment of a container for aerosol cans;  
FIG. 10 is a front view of FIG. 9;  
FIG. 11 is a bottom view of FIG. 9;  
FIG. 12 is a top view of FIG. 9;  
FIG. 13 is an elevated perspective front view of FIG. 9;  
FIG. 14 is an elevated rear perspective view of FIG. 9;  
FIG. 15 is a right side view of FIG. 9; and,  
FIG. 16 is a rear view of FIG. 9.

(56) **References Cited**  
**U.S. PATENT DOCUMENTS**

- 316,033 A \* 4/1885 Czech ..... 261/71
- 354,686 A \* 12/1886 Ricci ..... 122/126
- 404,294 A \* 5/1889 De Baschmakoff ..... 283/39
- 404,305 A \* 5/1889 De Baschmakoff ..... 33/803
- 2,652,707 A \* 9/1953 Reilly, Jr. et al. .... 239/579
- 3,161,330 A \* 12/1964 Sagarin et al. .... 222/402.24
- D244,424 S \* 5/1977 Petterson ..... D9/692
- 4,132,359 A \* 1/1979 Nozawa ..... 239/333
- 4,185,776 A \* 1/1980 Nozawa ..... 239/333
- D285,538 S \* 9/1986 Trumstedt ..... D9/526
- 4,819,832 A \* 4/1989 Lawson ..... 222/153.13
- D344,230 S \* 2/1994 Bertolini ..... D9/689
- 5,348,193 A \* 9/1994 Bruckner et al. .... 222/175
- 5,458,263 A \* 10/1995 Ciammitti et al. .... 222/153.1
- D381,261 S \* 7/1997 Crawford ..... D9/686
- 5,755,218 A \* 5/1998 Johansson et al. .... 128/200.14
- 5,788,123 A \* 8/1998 Hackmann et al. .... 222/153.13
- D402,193 S \* 12/1998 Bell et al. .... D9/693

**1 Claim, 9 Drawing Sheets**

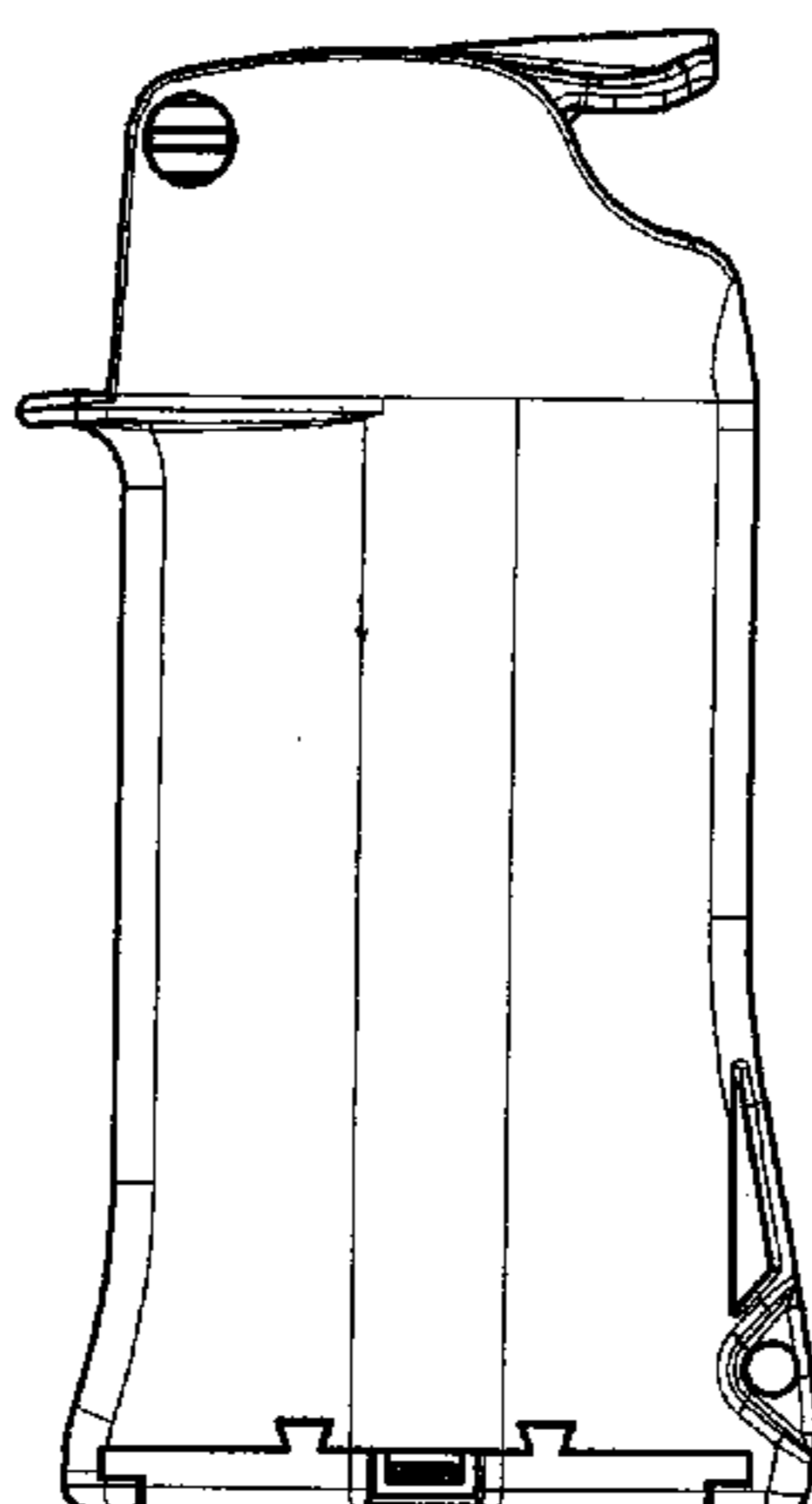

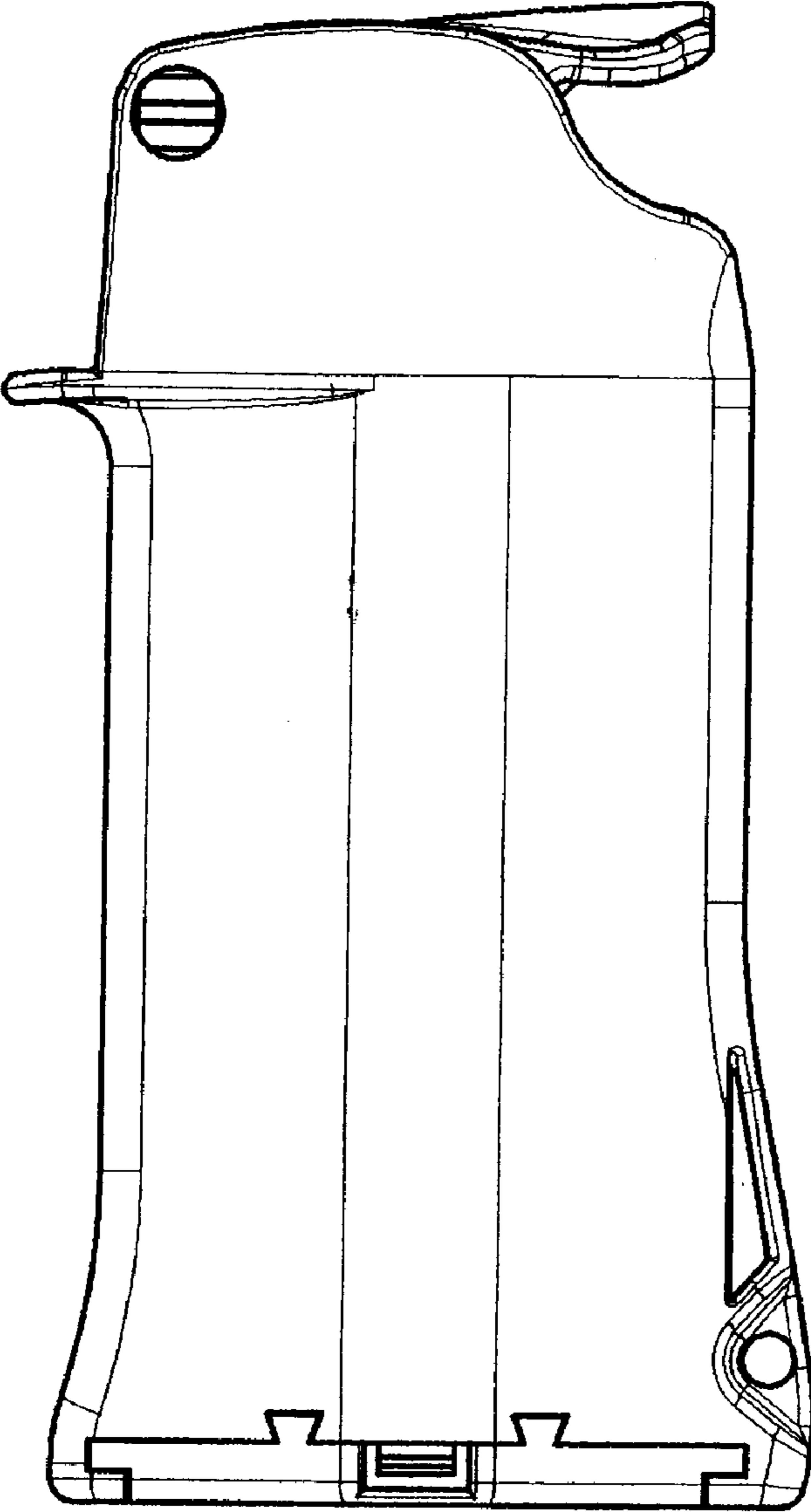

FIGURE 1

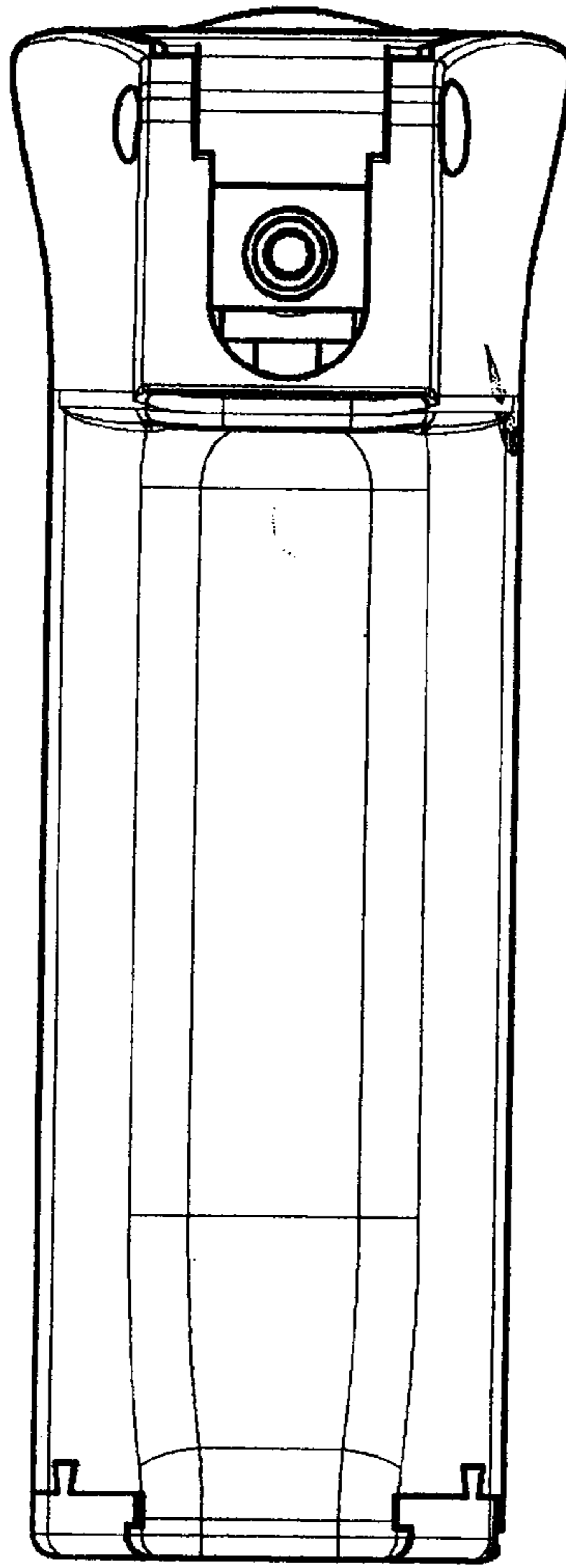

FIGURE 2

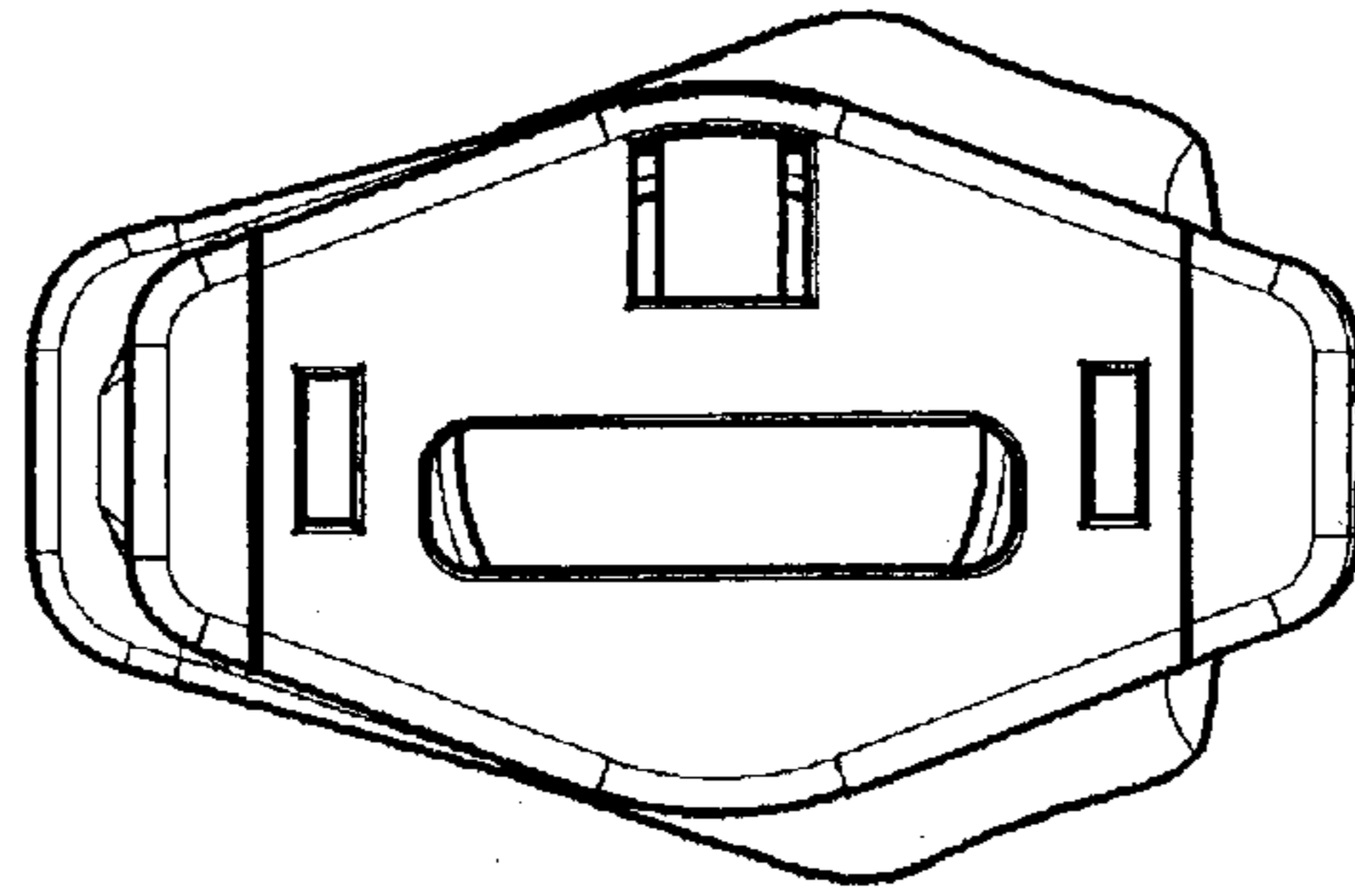

FIGURE 3

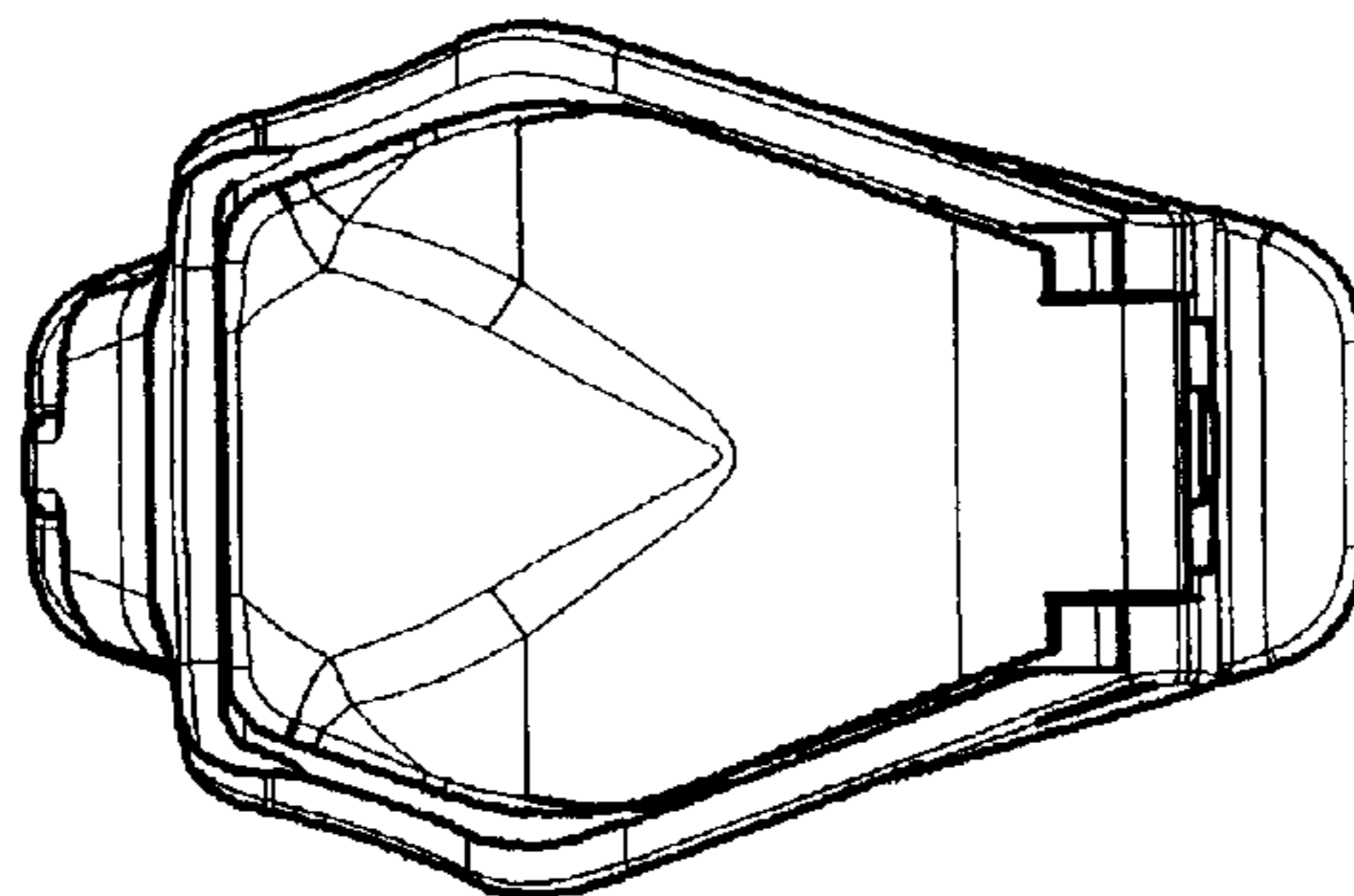

FIGURE 4

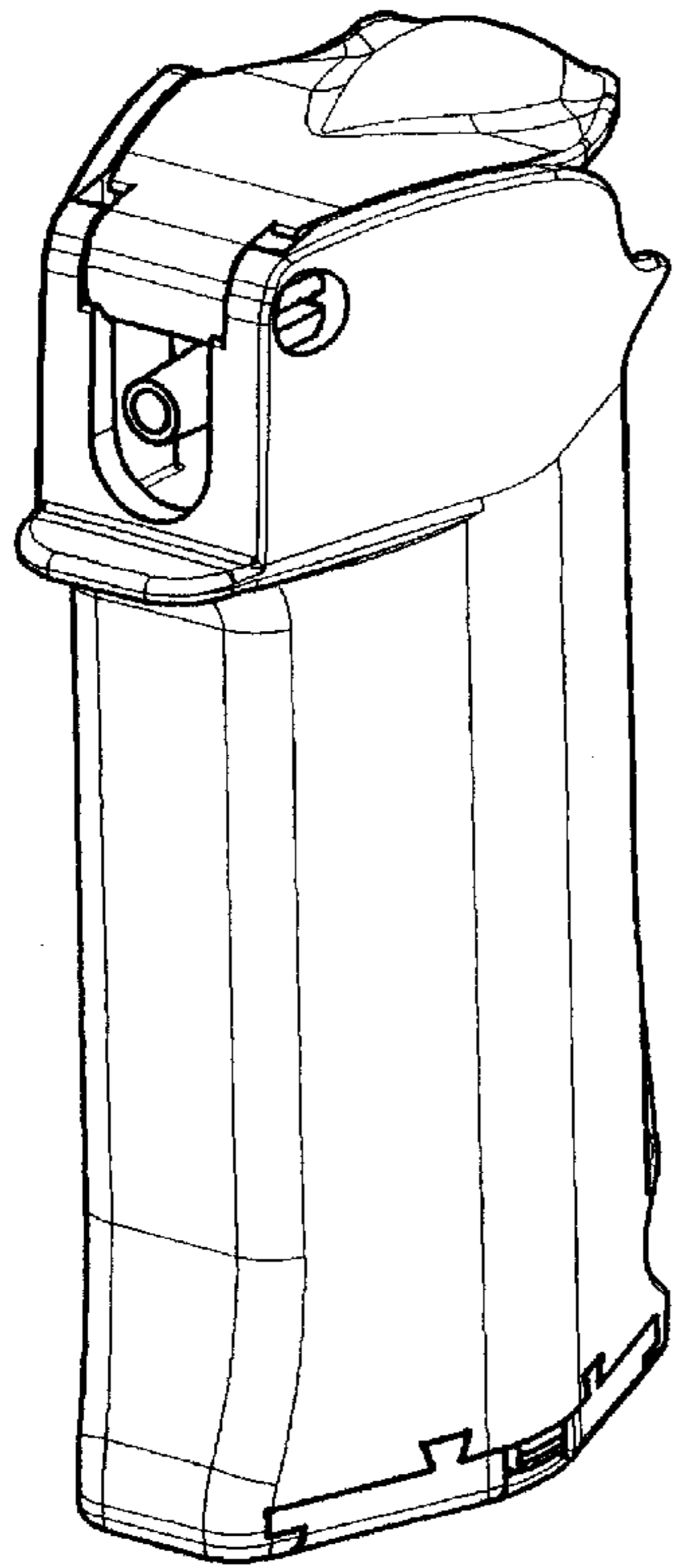

FIGURE 5

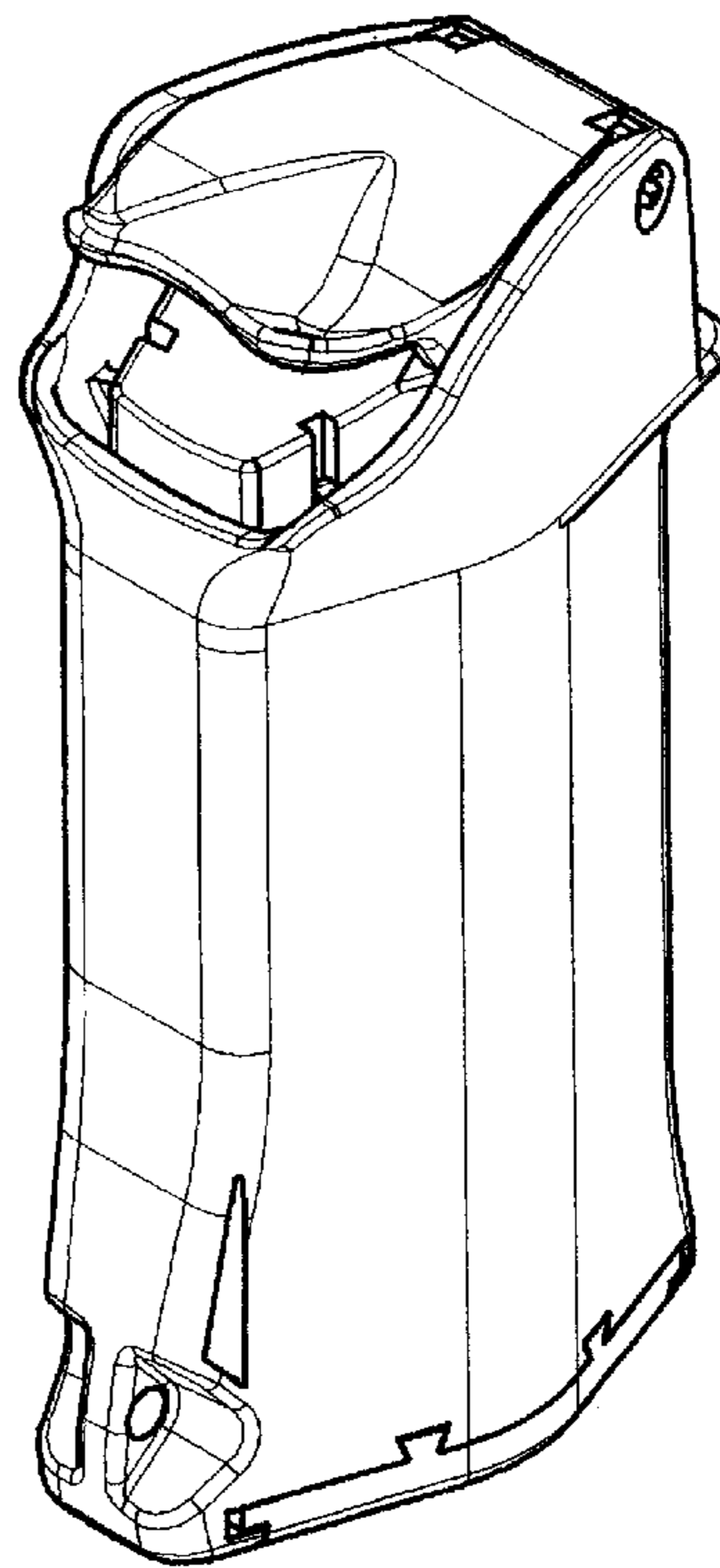

FIGURE 6

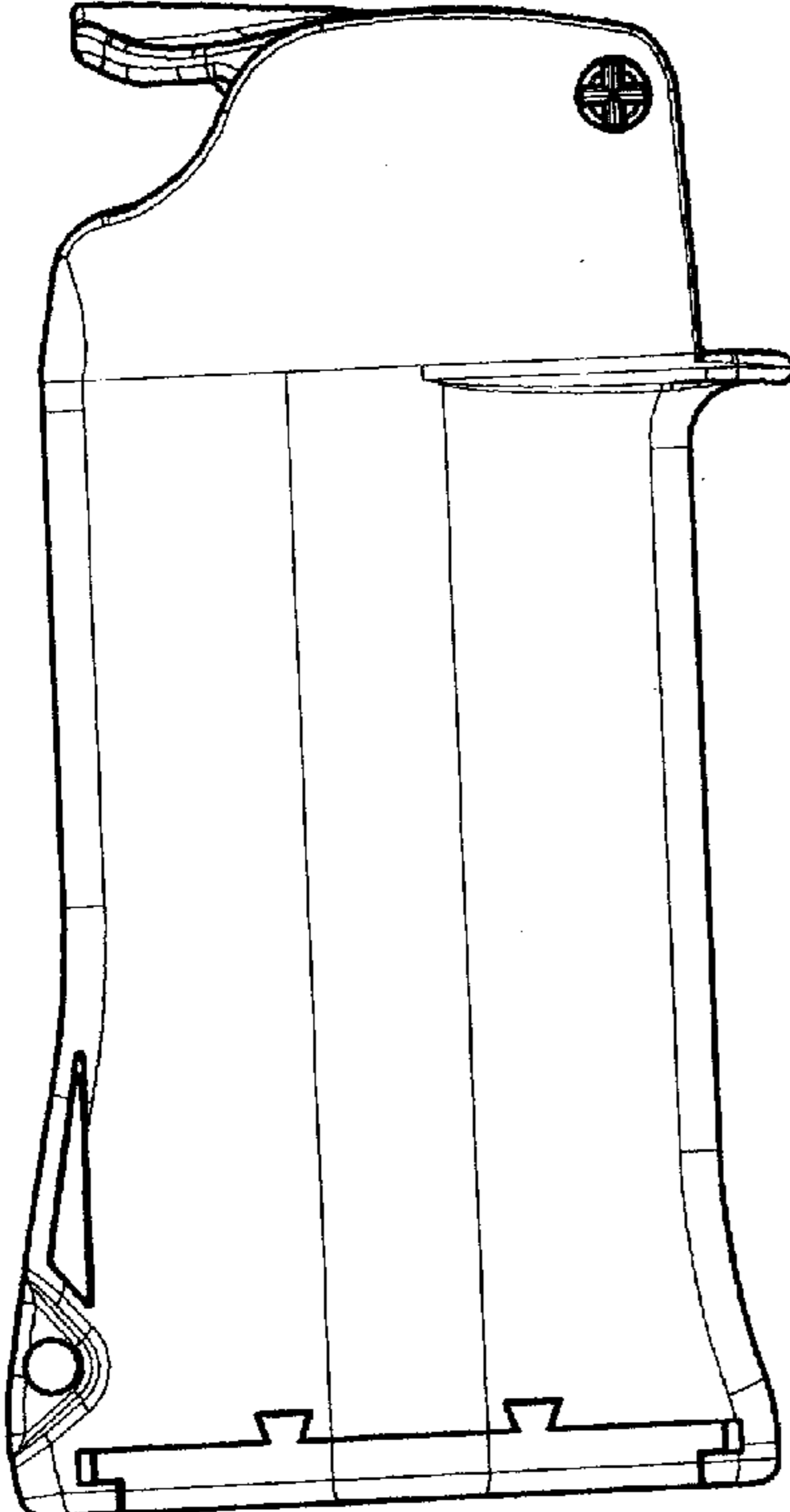

FIGURE 7

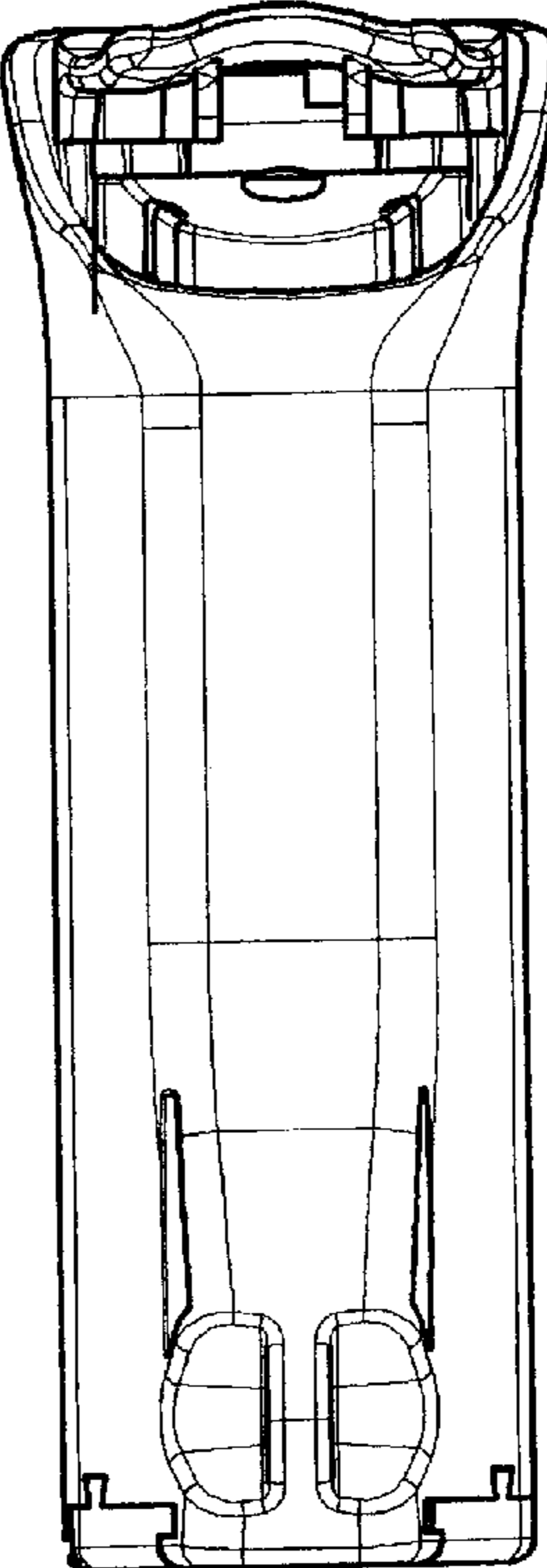

FIGURE 8

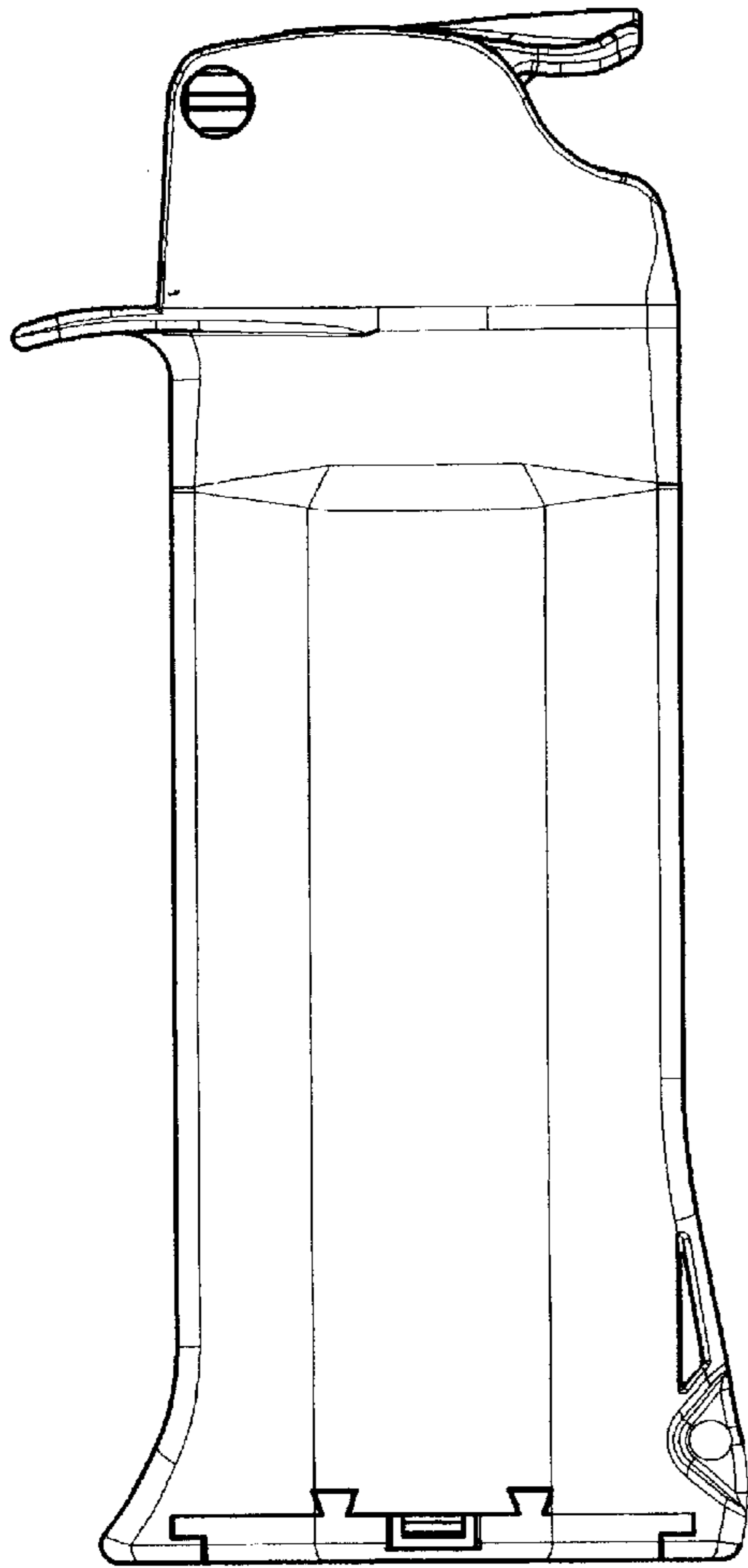

FIGURE 9

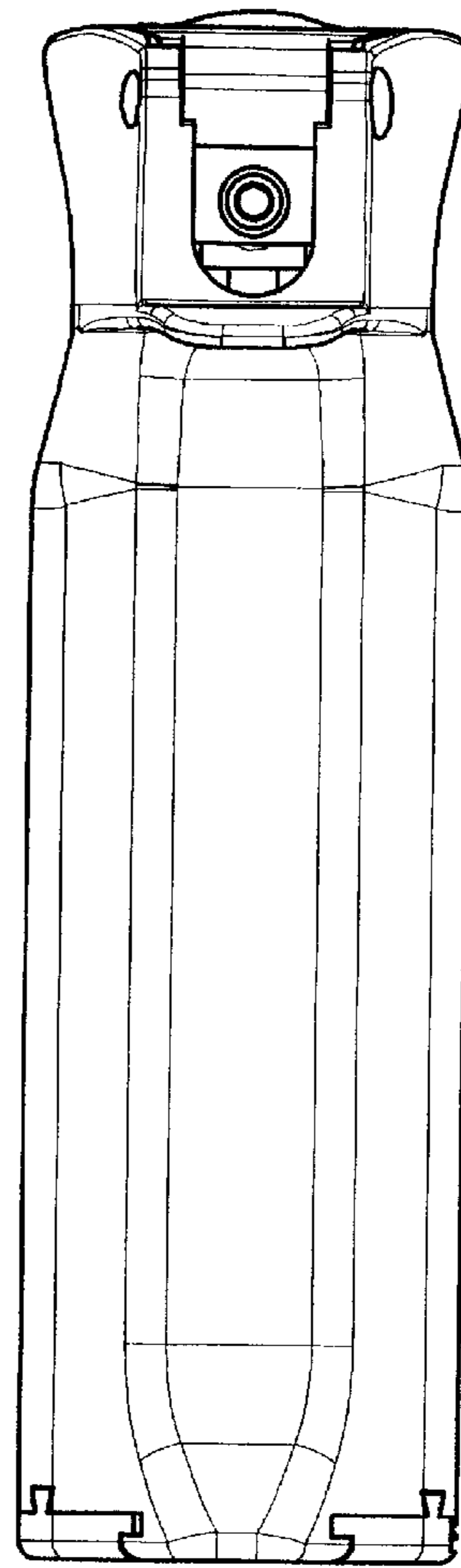

FIGURE 10



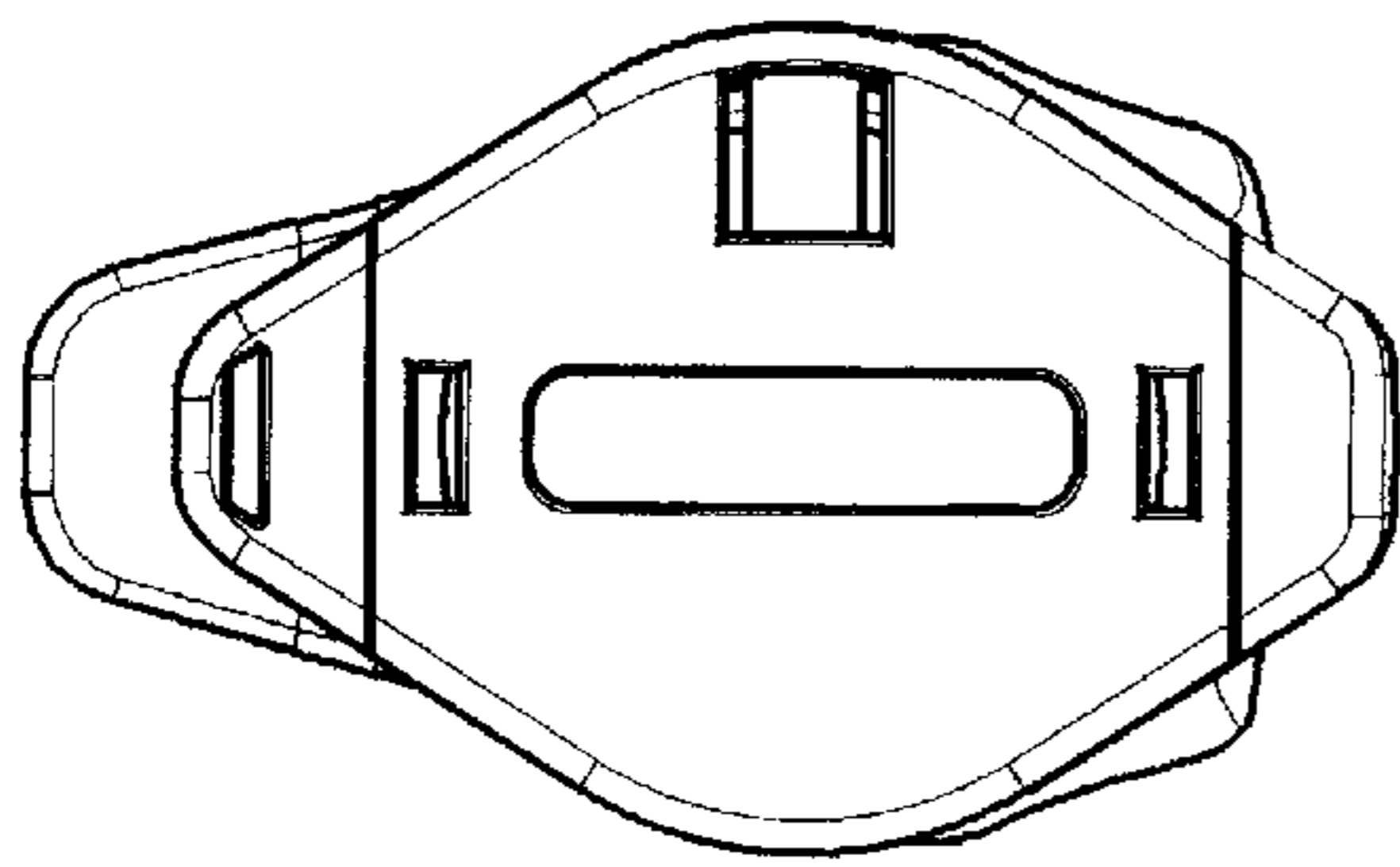

FIGURE 11

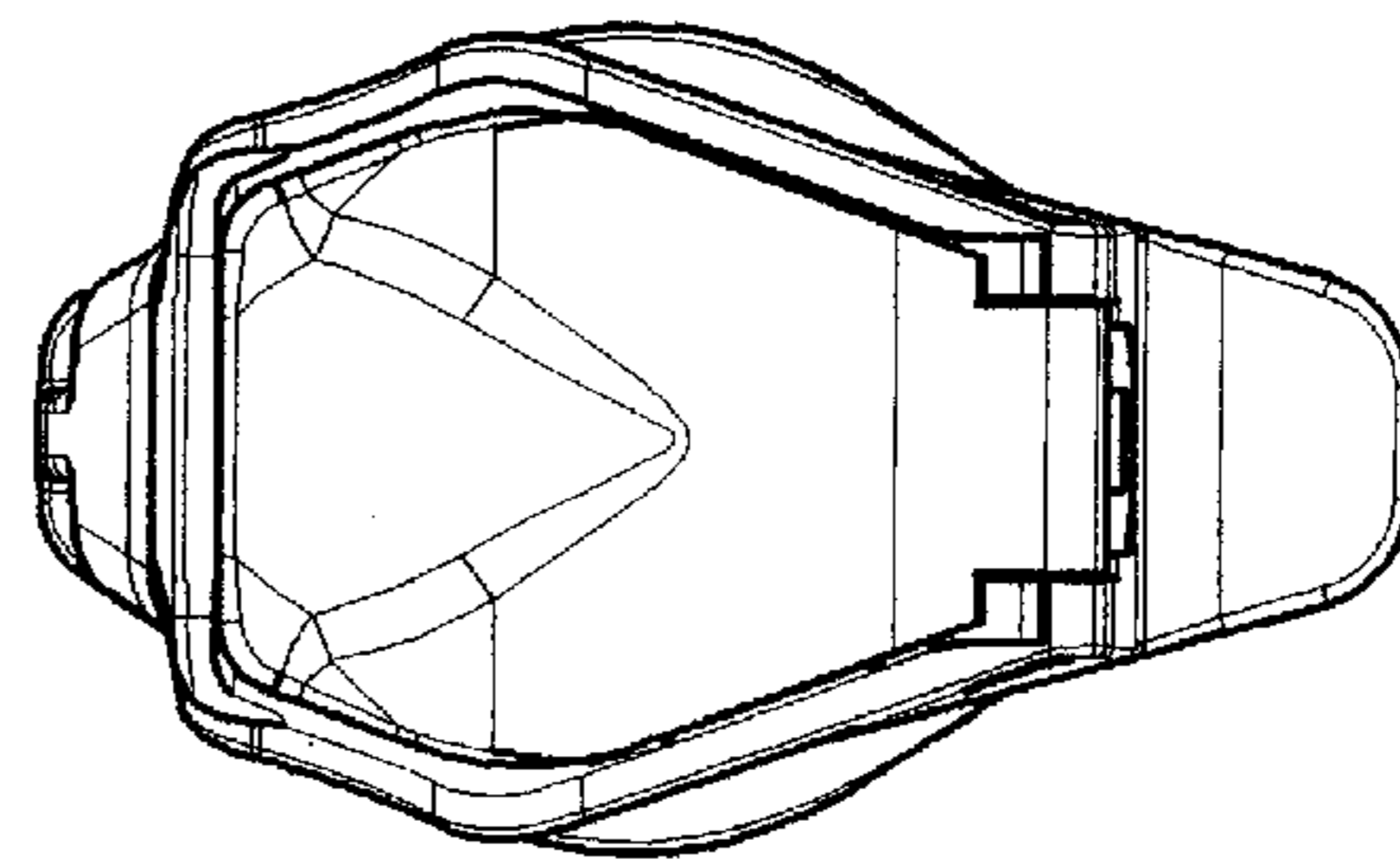

FIGURE 12



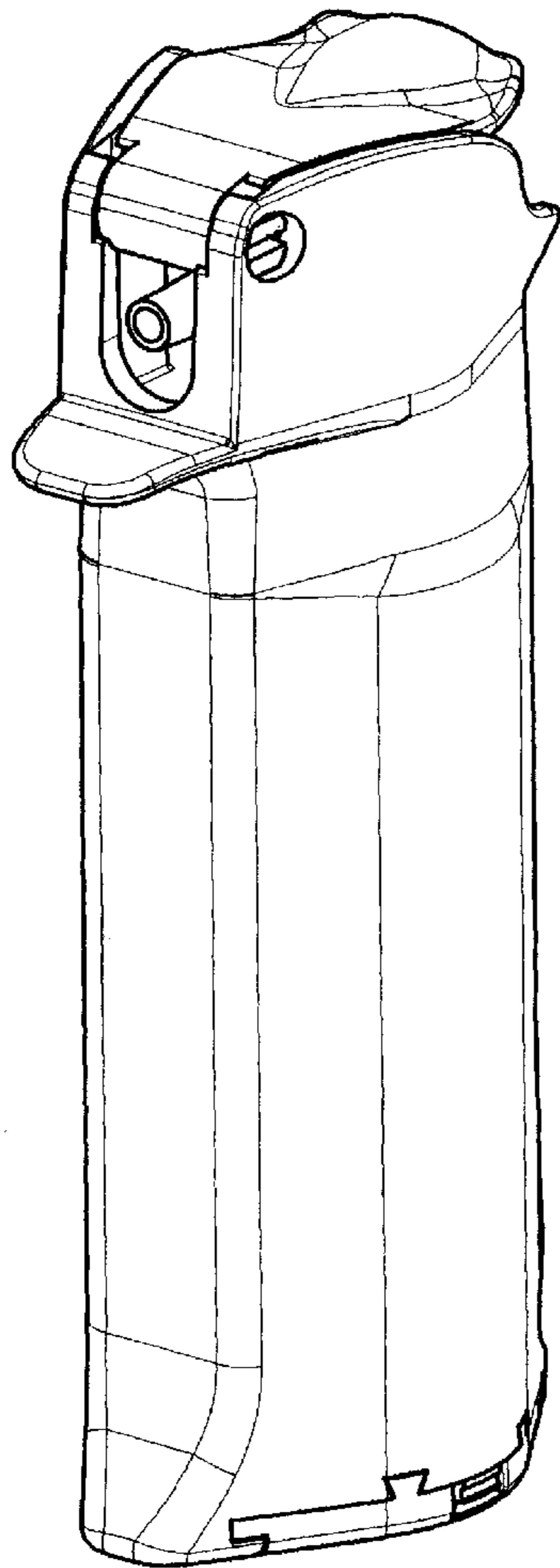

FIGURE 13

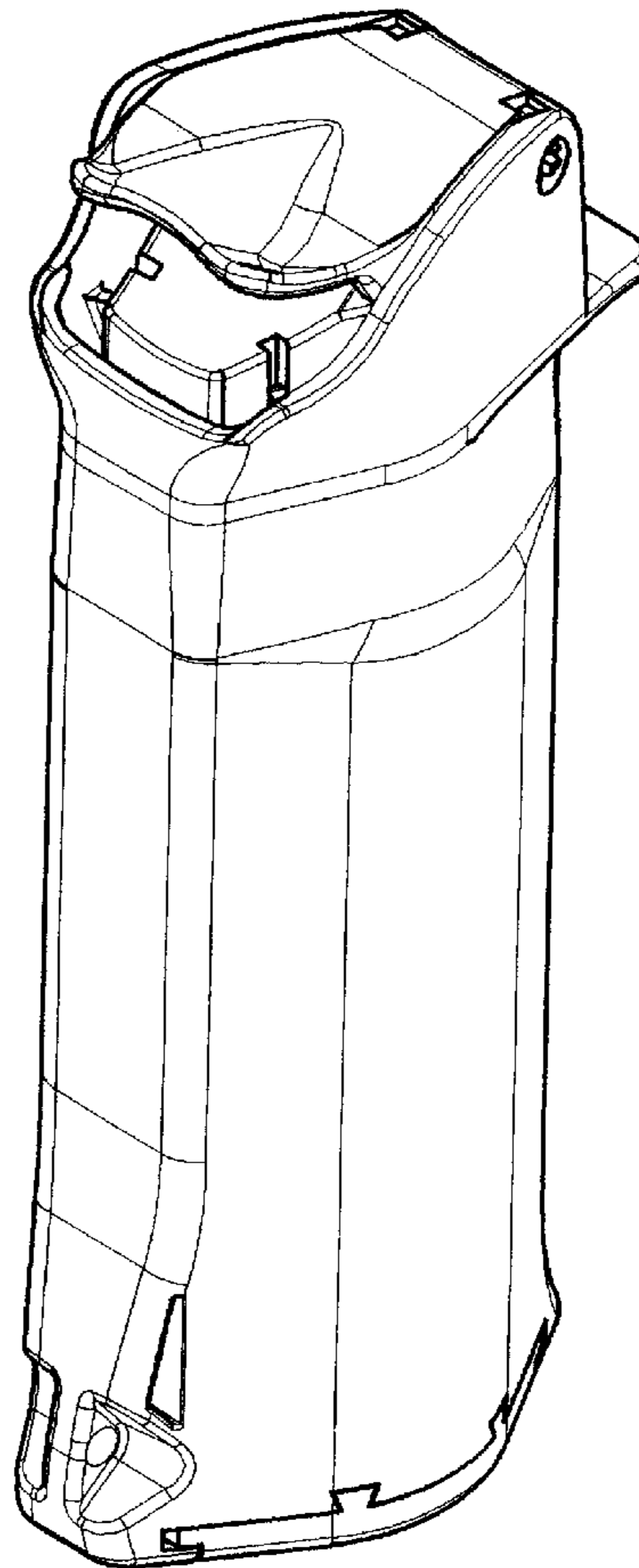

FIGURE 14

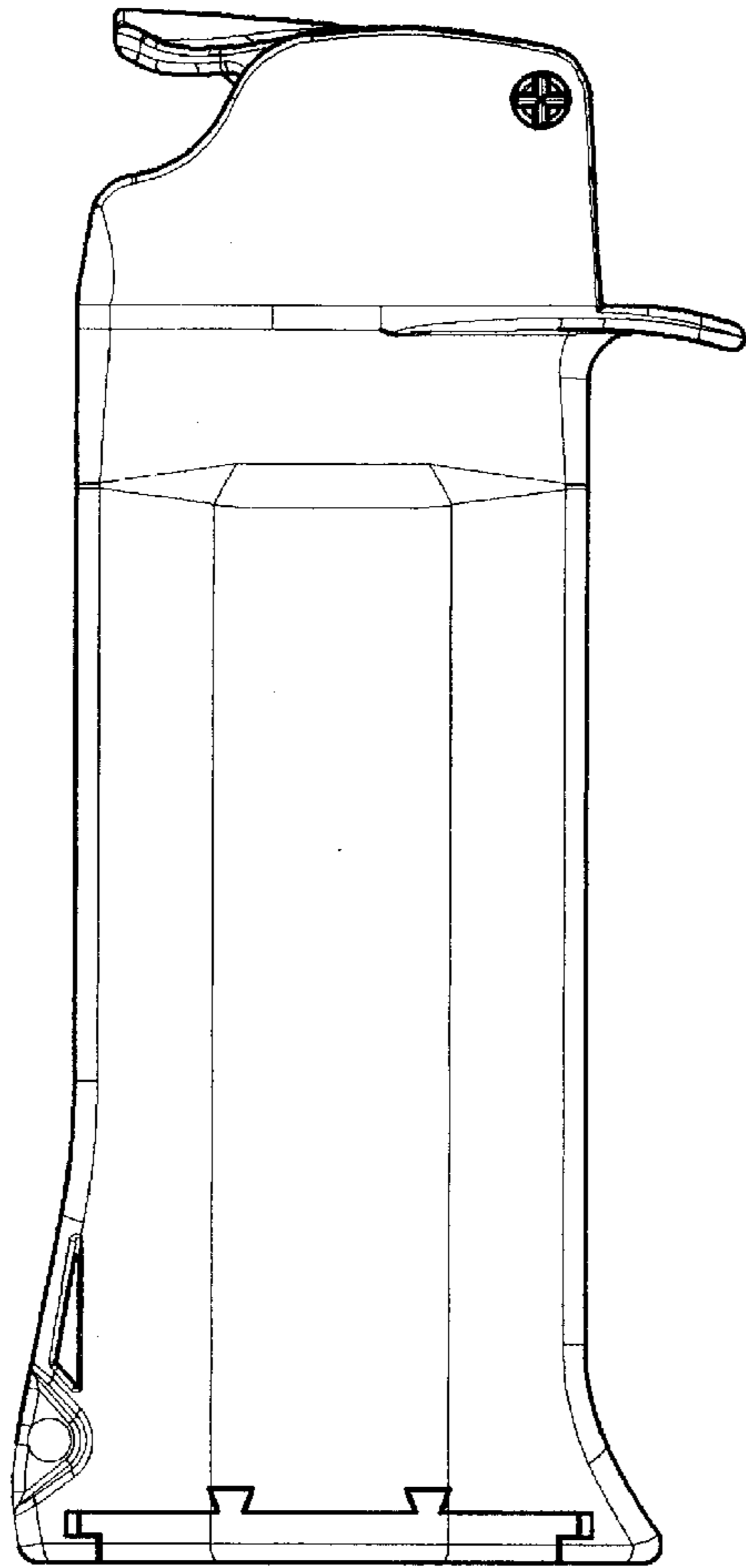

FIGURE 15

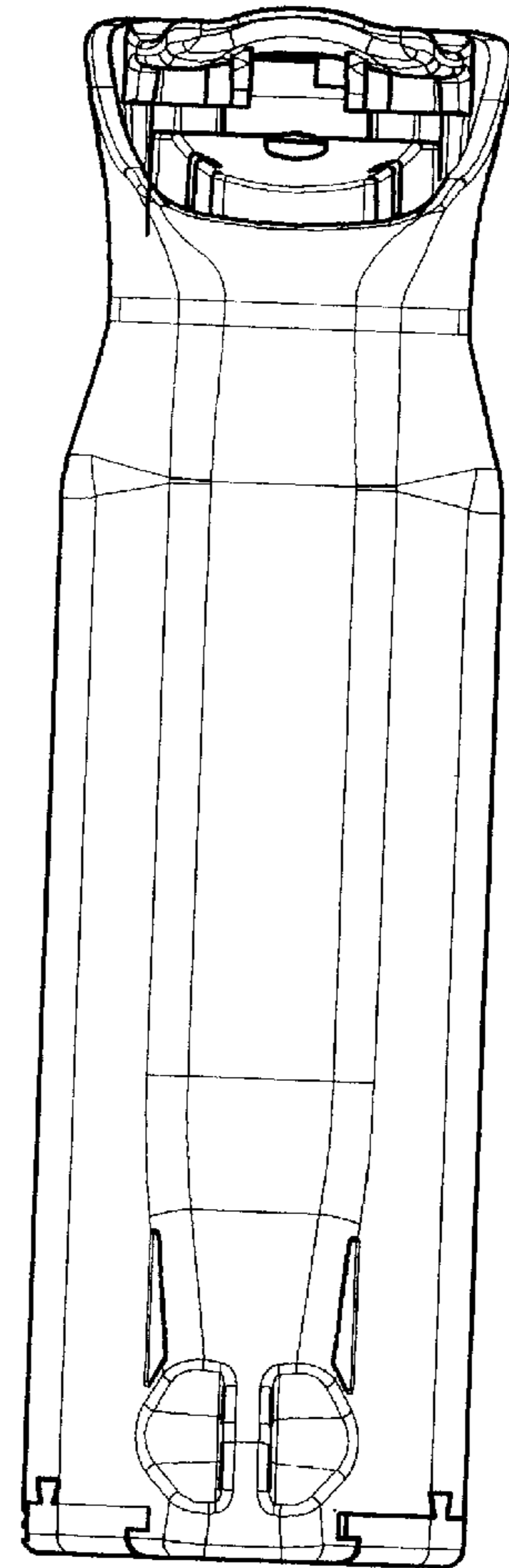

FIGURE 16