



US00D511940S

(12) **United States Design Patent**  
**Kim**

(10) **Patent No.:** **US D511,940 S**

(45) **Date of Patent:** **\*\* Nov. 29, 2005**

(54) **SAUCE POT**

(75) **Inventor:** **Chang-Ho Kim, Incheon (KR)**

(73) **Assignee:** **Hana Cobi Co., Ltd., Incheon (KR)**

(\*\*) **Term:** **14 Years**

(21) **Appl. No.:** **29/204,020**

(22) **Filed:** **Apr. 23, 2004**

(30) **Foreign Application Priority Data**

Dec. 29, 2003 (KR) ..... 30-2003-0037077

(51) **LOC (8) Cl.** ..... **07-06**

(52) **U.S. Cl.** ..... **D7/598**

(58) **Field of Search** ..... D7/590, 598, 629,  
D7/300.1; D9/547, 523; 222/459, 480, 544,  
547; 220/254.3, 792, 780-806

(56) **References Cited**

**U.S. PATENT DOCUMENTS**

2,752,971 A \* 7/1956 Tupper ..... 220/4.03  
2,754,866 A \* 7/1956 Coltman, Jr. .... 220/254.3  
D233,116 S \* 10/1974 Swett ..... D7/300.1

D254,241 S \* 2/1980 Morin ..... D7/612  
D262,855 S \* 2/1982 Morin ..... D7/598  
D328,010 S \* 7/1992 Daenen et al. .... D7/591  
D328,014 S \* 7/1992 DeCoster et al. .... D7/629  
D421,547 S \* 3/2000 Demers ..... D7/510

\* cited by examiner

*Primary Examiner*—Terry A. Wallace

(74) *Attorney, Agent, or Firm*—Birch, Stewart, Kolasch & Birch, LLP

(57) **CLAIM**

The ornamental design for a sauce pot, as shown.

**DESCRIPTION**

FIG. 1 is a front, right perspective view of the sauce pot showing my new design;  
FIG. 2 is a front view thereof;  
FIG. 3 is a rear view thereof;  
FIG. 4 is a left-side view thereof;  
FIG. 5 is a right-side view thereof;  
FIG. 6 is a top plan view thereof; and,  
FIG. 7 is a bottom plan view thereof.

**1 Claim, 6 Drawing Sheets**

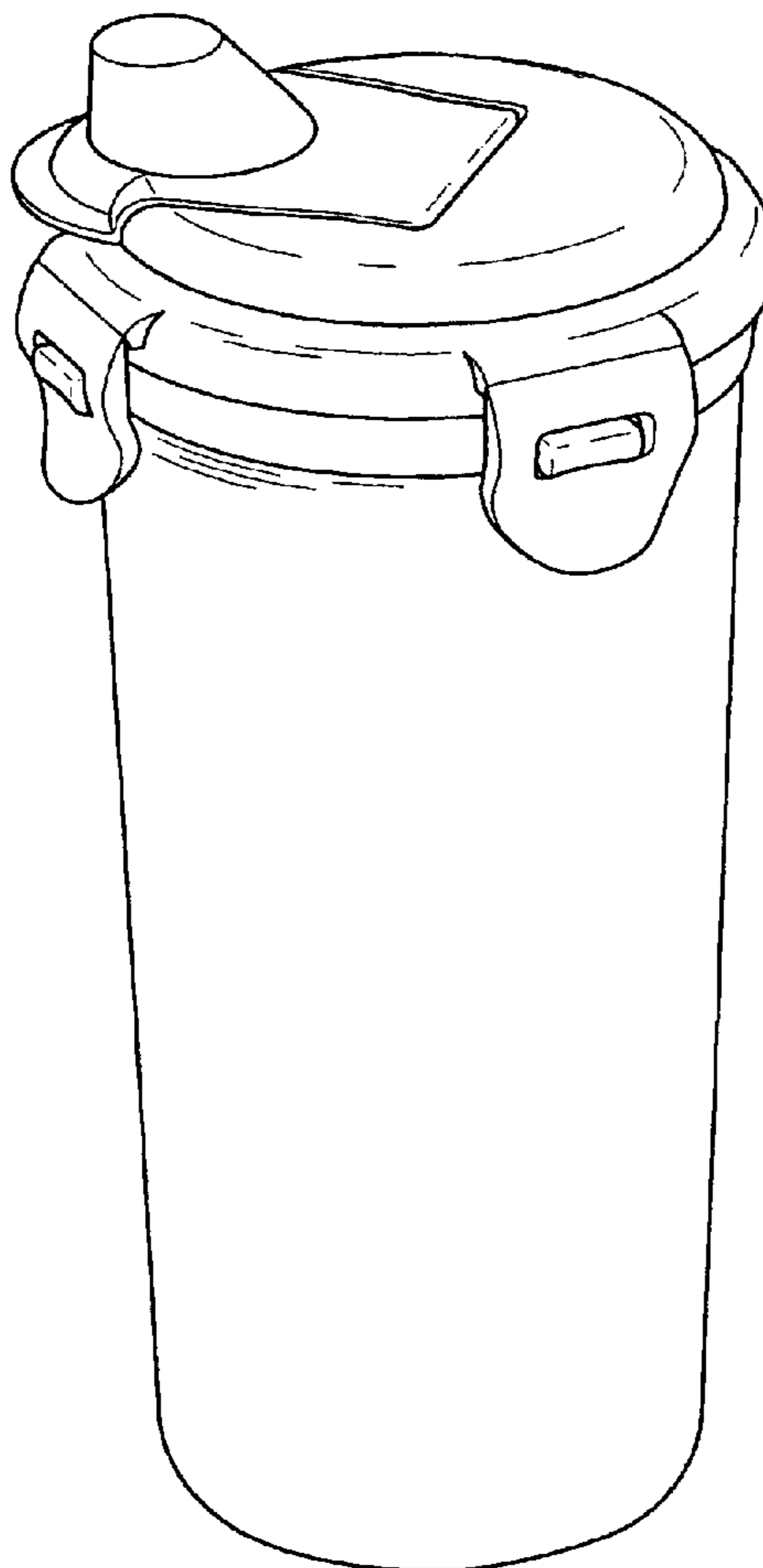

Fig. 1

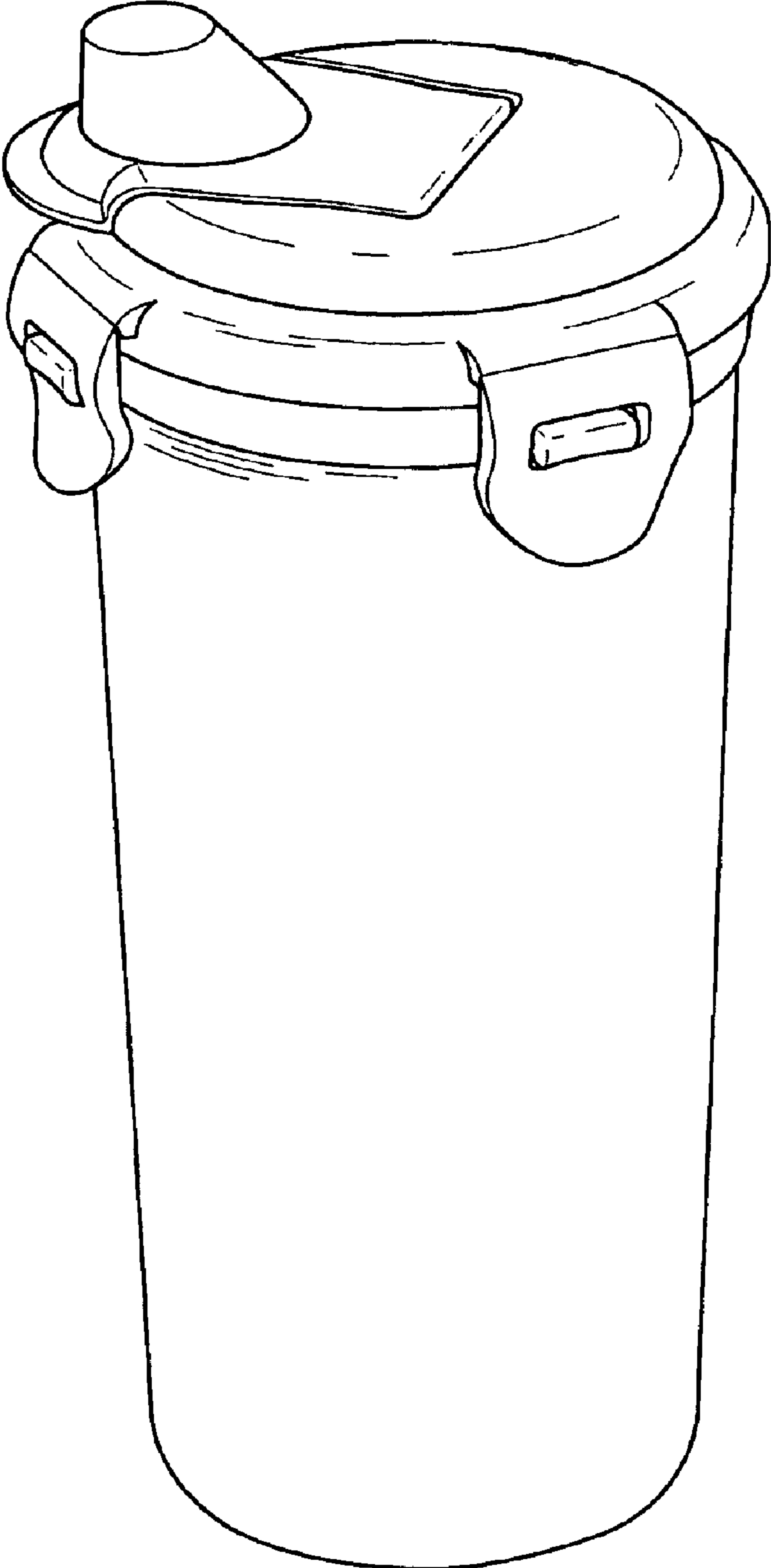

Fig.2

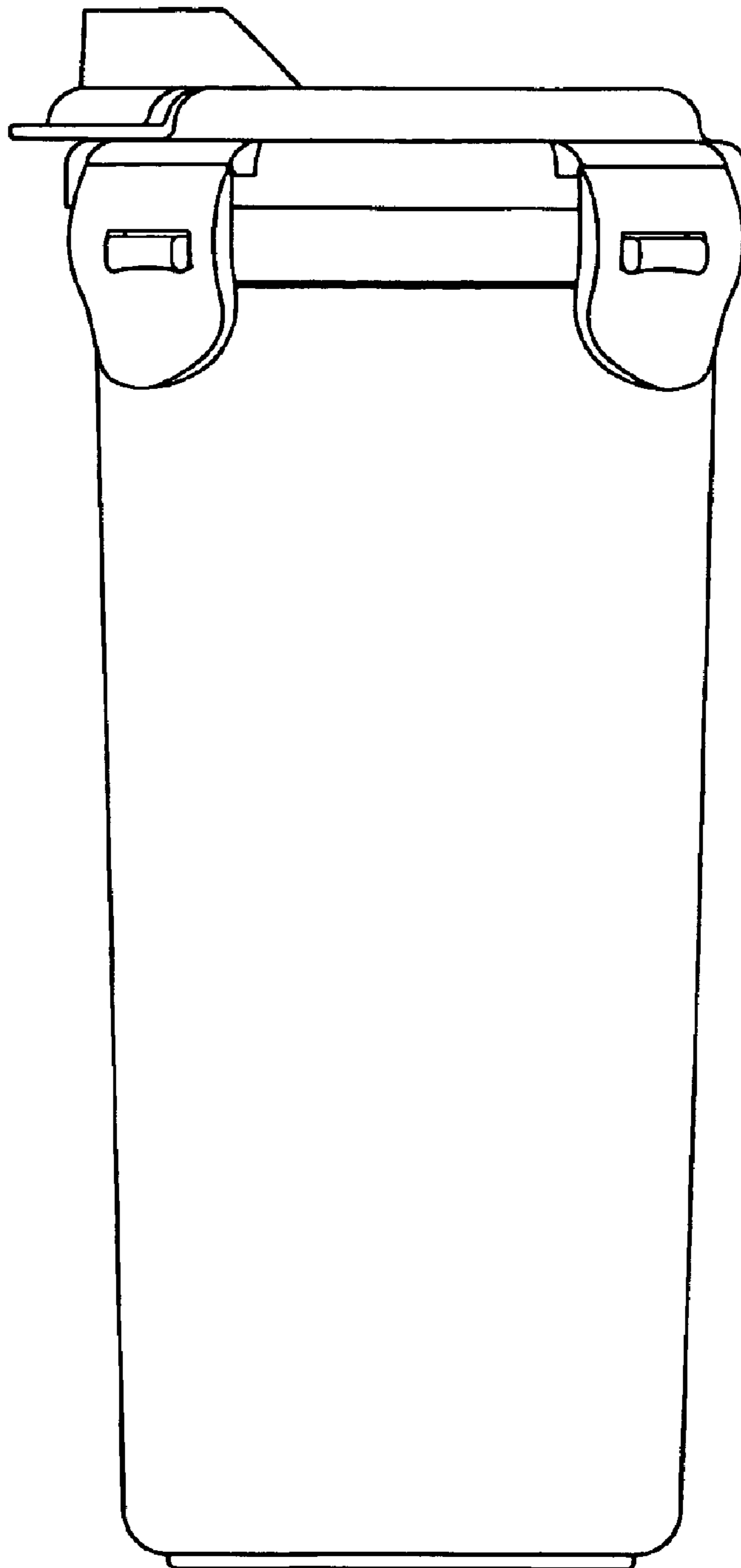

Fig.3

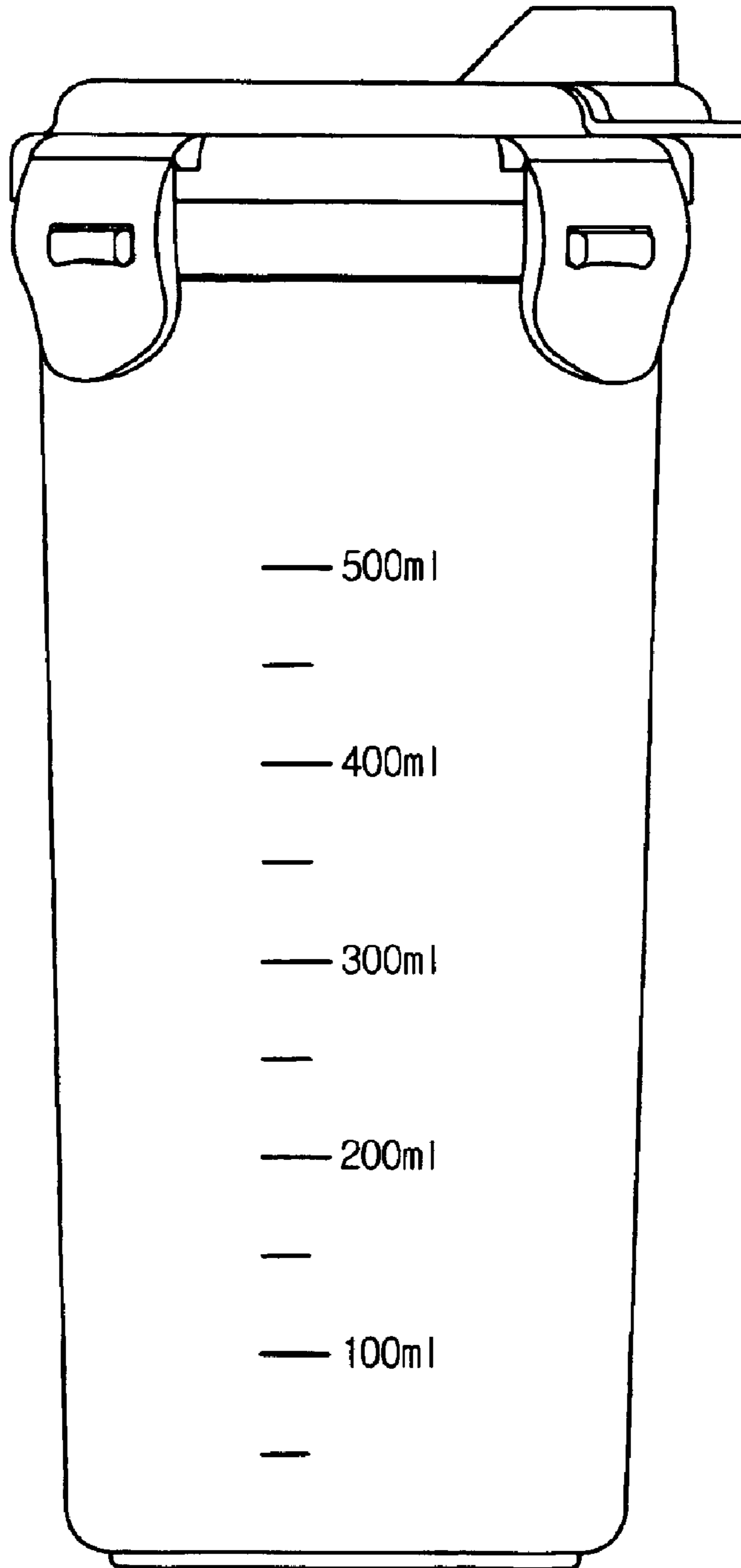

Fig.4

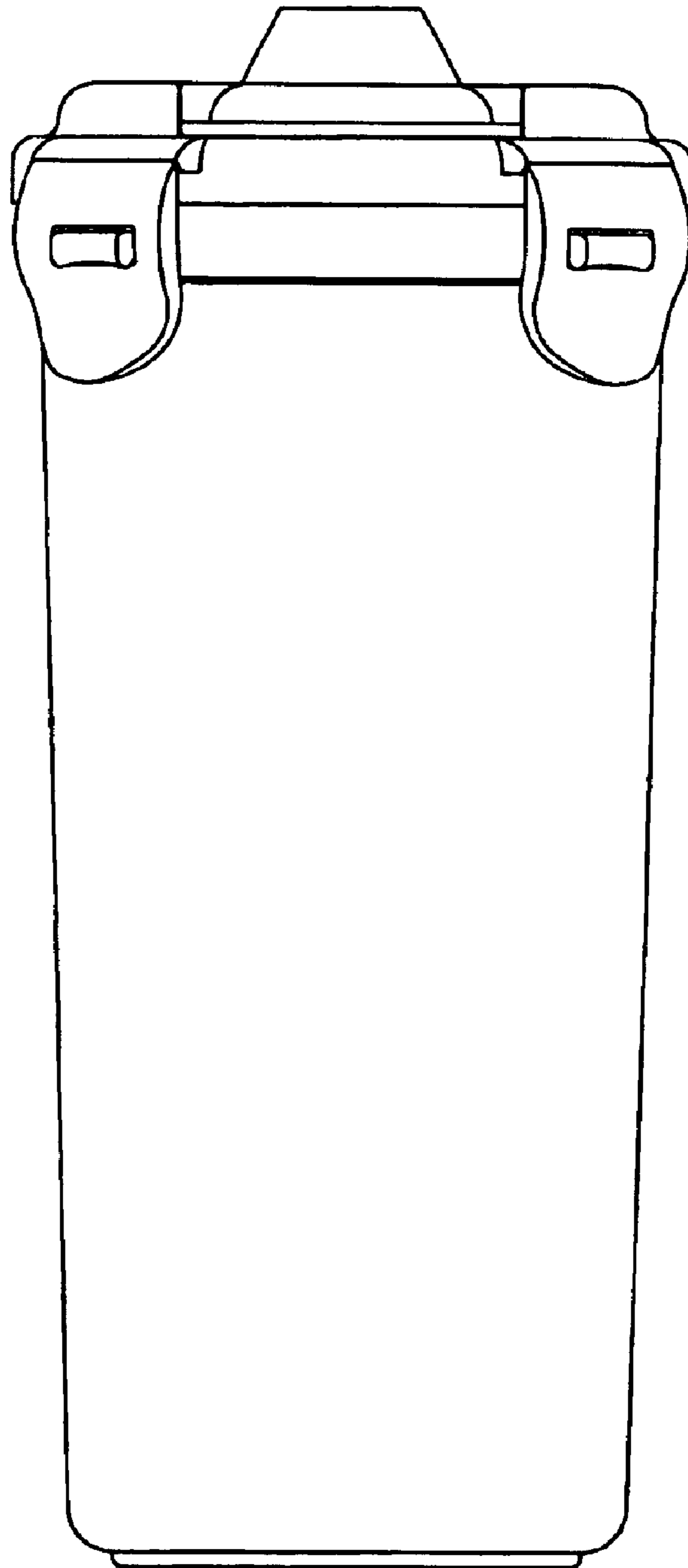

Fig.5

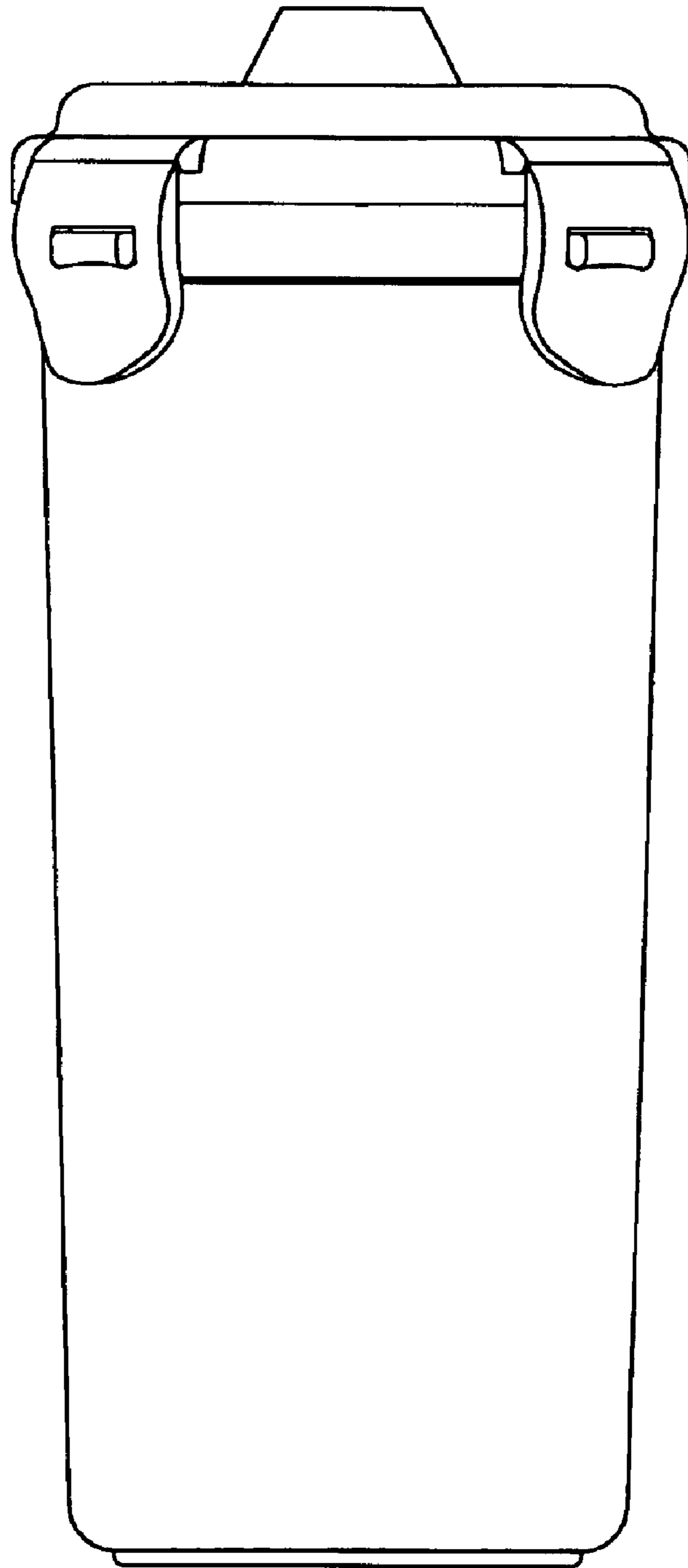

Fig.6

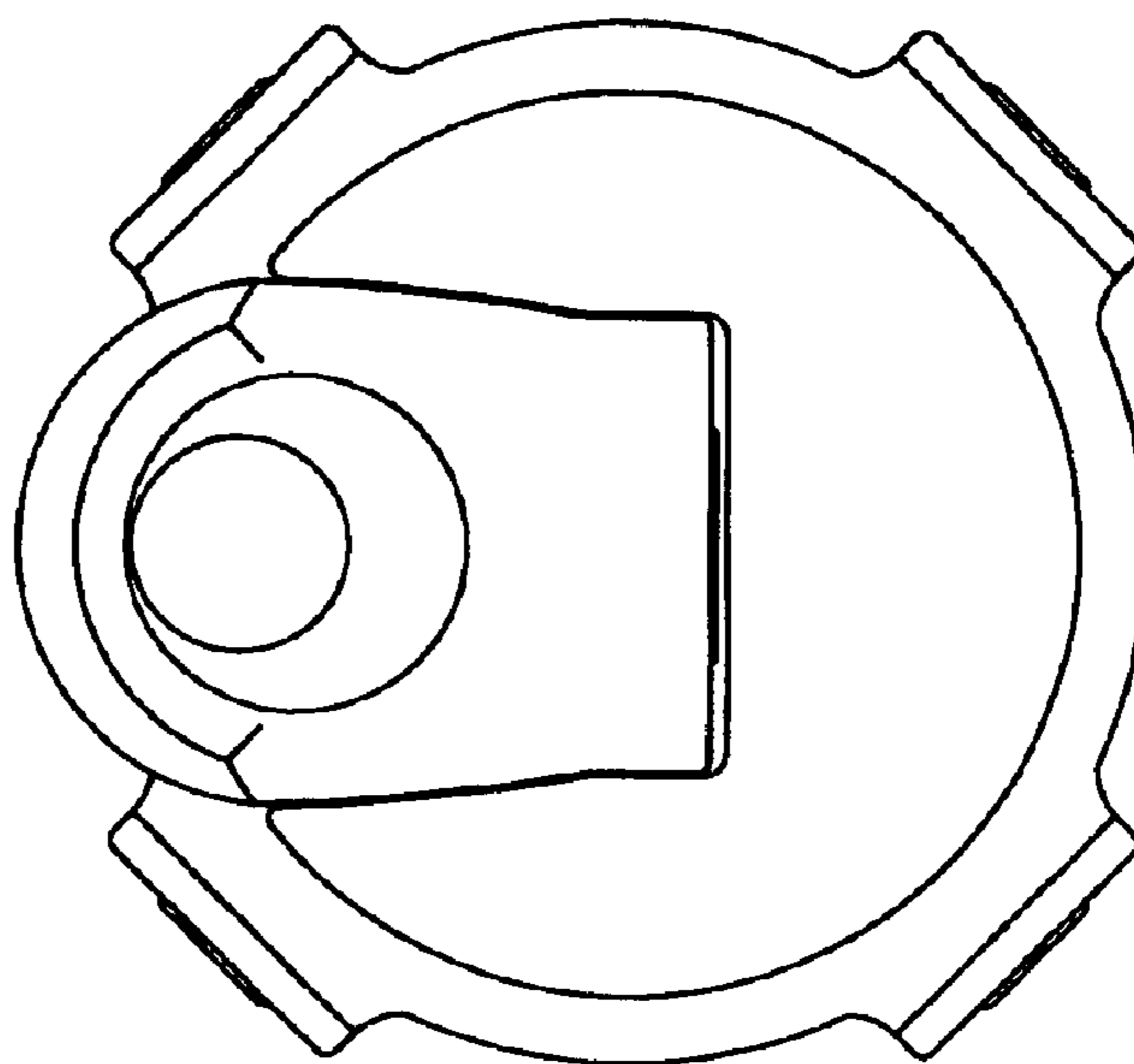

Fig.7

