



US00D511919S

(12) **United States Design Patent** (10) **Patent No.:** **US D511,919 S**
Descoteaux (45) **Date of Patent:** **** Nov. 29, 2005**

(54) **BATTERY POWERED TOOTHBRUSH HOLDER**

(76) Inventor: **Donald J. Descoteaux**, 20 Coachman La., Methuen, MA (US) 01844

(**) Term: **14 Years**

(21) Appl. No.: **29/195,049**

(22) Filed: **Dec. 8, 2003**

(51) **LOC (8) Cl.** **23-02**

(52) **U.S. Cl.** **D6/534**

(58) **Field of Search** D6/534, 528; D3/901; 206/209, 209.1; 211/13.1, 60.1, 65, 66, 87.01, 89.01

(56) **References Cited**

U.S. PATENT DOCUMENTS

D100,426 S	*	7/1936	Hunt	D6/534
2,608,294 A		8/1952	Ward		
D189,567 S		1/1961	Clayton		
3,194,621 A		7/1965	Frost		
3,450,269 A		6/1969	Simeti		
D268,531 S	*	4/1983	Leppard	D6/534
D305,590 S	*	1/1990	Vance	D6/534

D341,943 S		12/1993	Si-Hoe		
5,769,245 A		6/1998	Butler		
D439,781 S		4/2001	Spore		
6,776,296 B2	*	8/2004	Herren	211/87.01
D502,546 S	*	3/2005	Shin	D6/534
2003/0089673 A1		5/2003	Herren		

* cited by examiner

Primary Examiner—Brian N Vinson

(57) **CLAIM**

The ornamental design for a battery powered toothbrush holder, as shown and described.

DESCRIPTION

FIG. 1 is a front elevational view of a battery powered toothbrush holder showing my new design; FIG. 2 is a rear elevational view thereof; FIG. 3 is a side elevational view thereof; FIG. 4 is a top plan view thereof; FIG. 5 is a bottom plan view thereof; and, FIG. 6 is a perspective view thereof. The broken-line disclosure of the toothbrush in the views is for illustrative purposes only and forms no part of the claimed design.

1 Claim, 3 Drawing Sheets

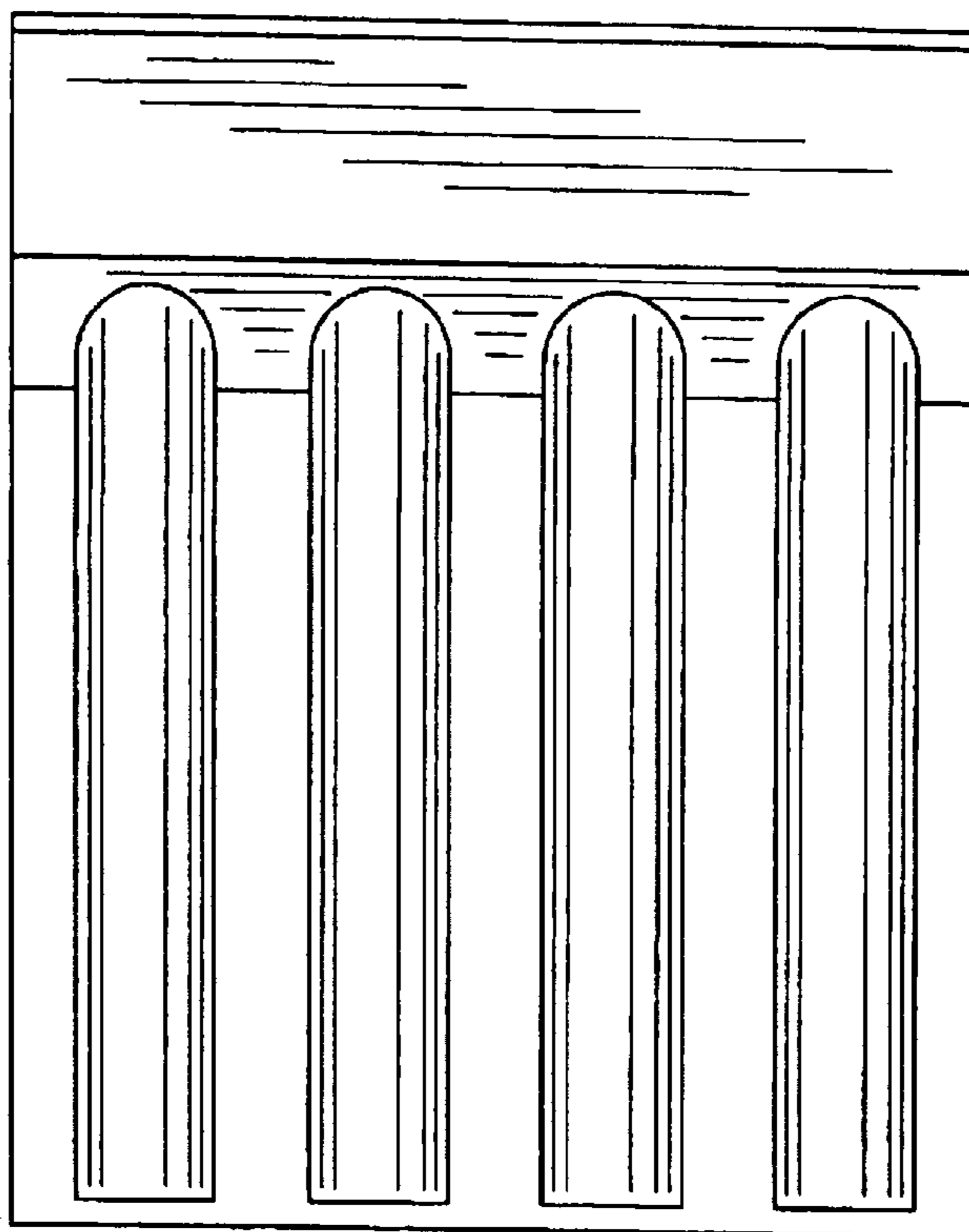

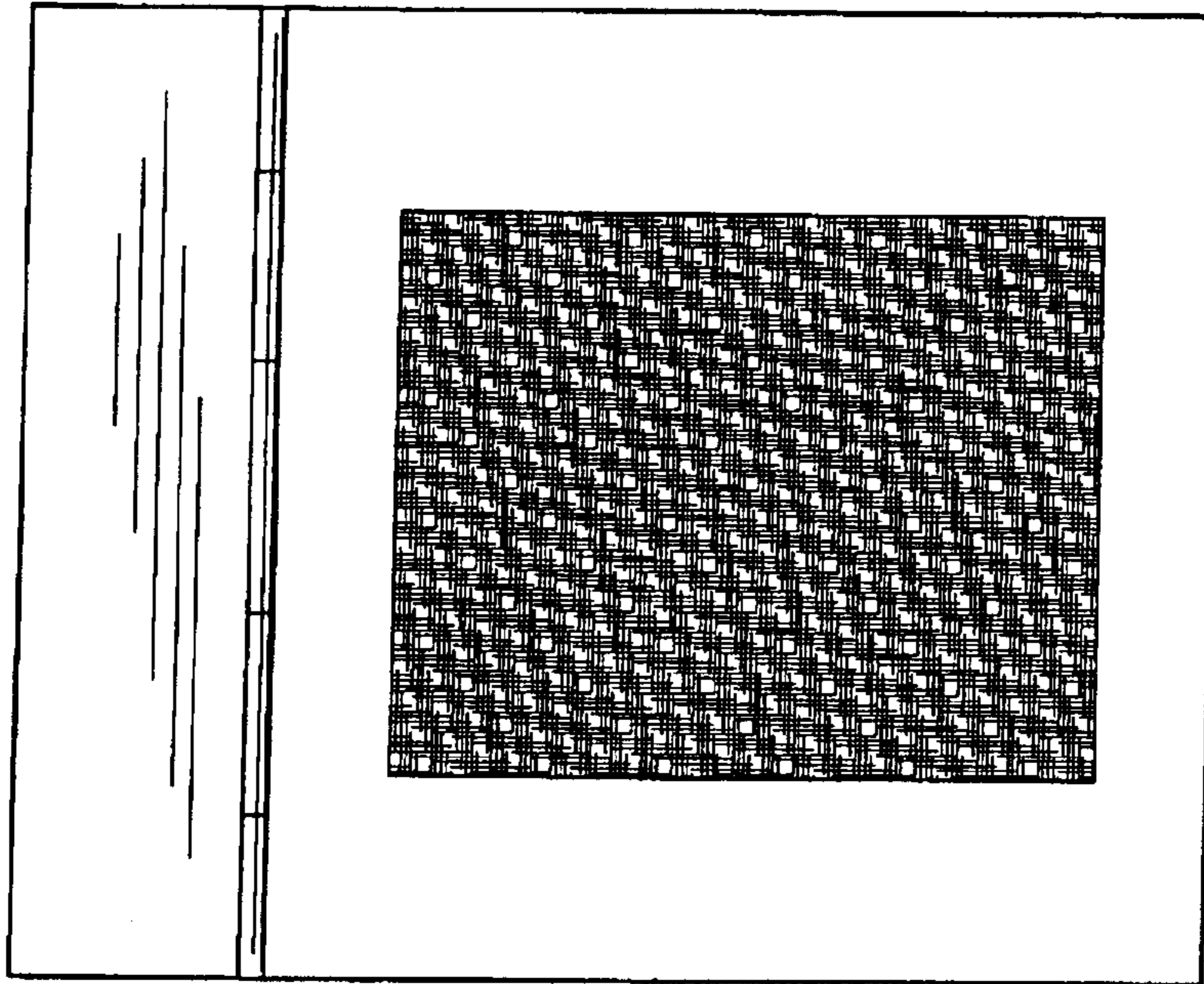

FIG. 2

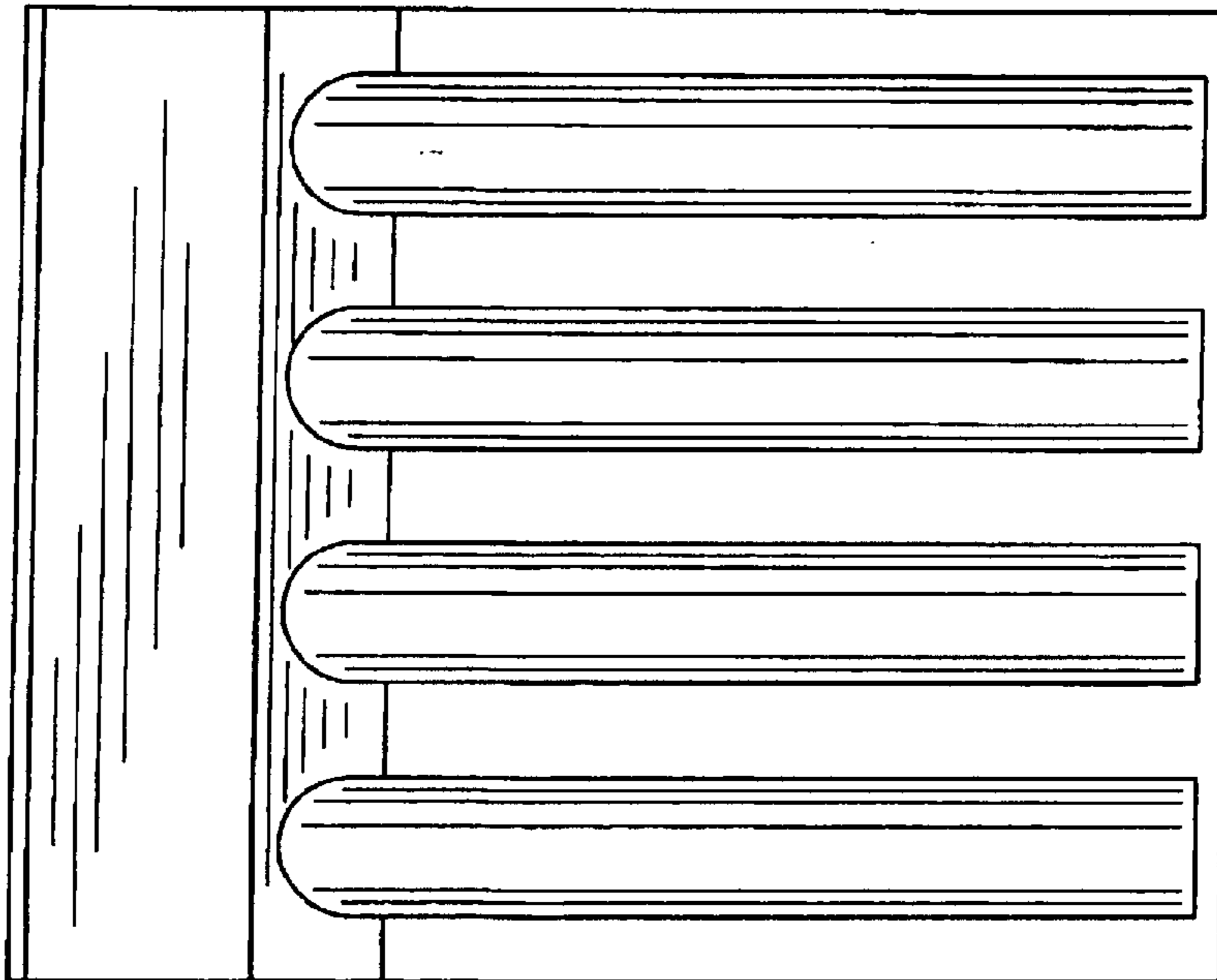

FIG. 1

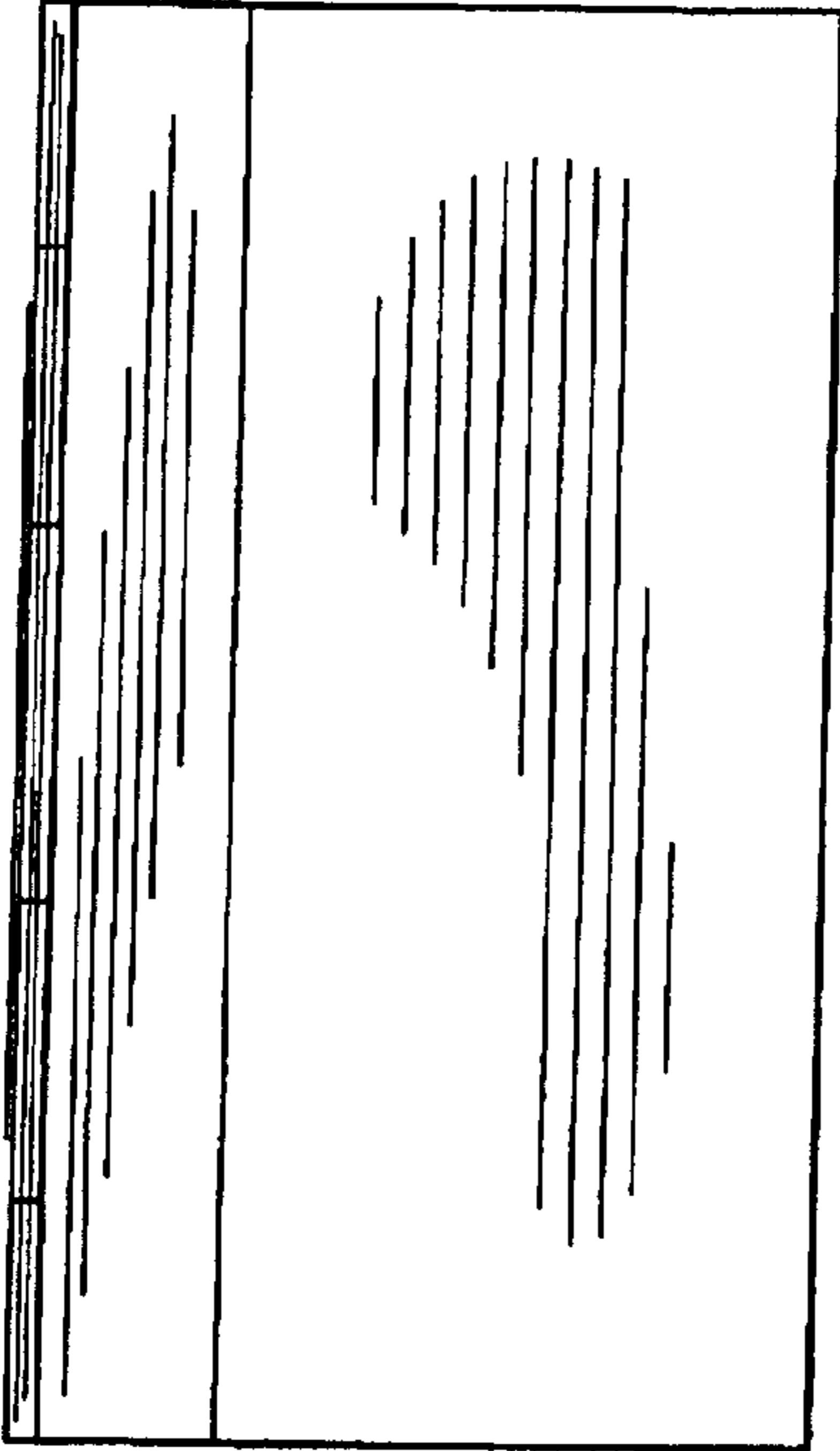

FIG. 4

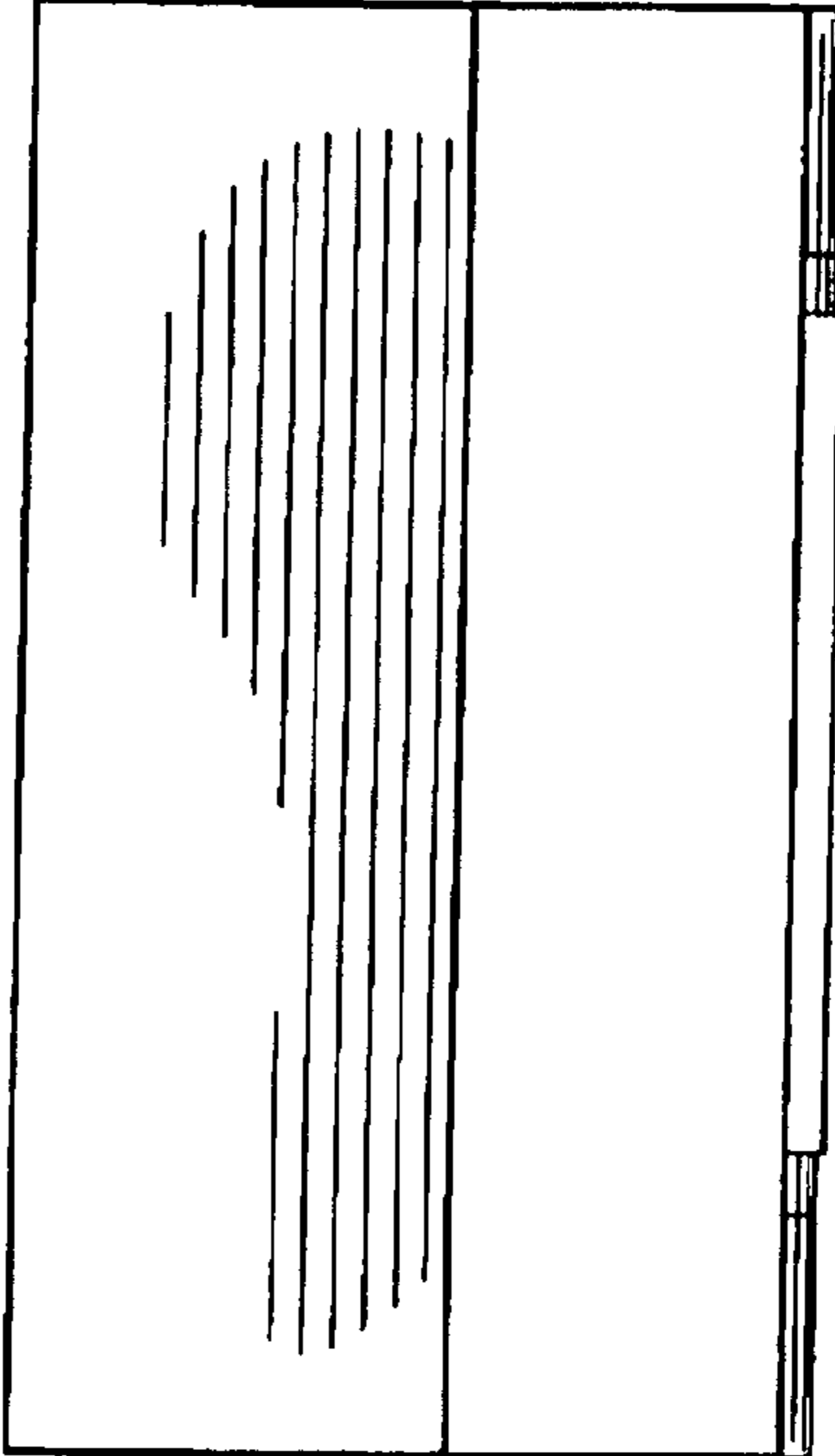

FIG. 5

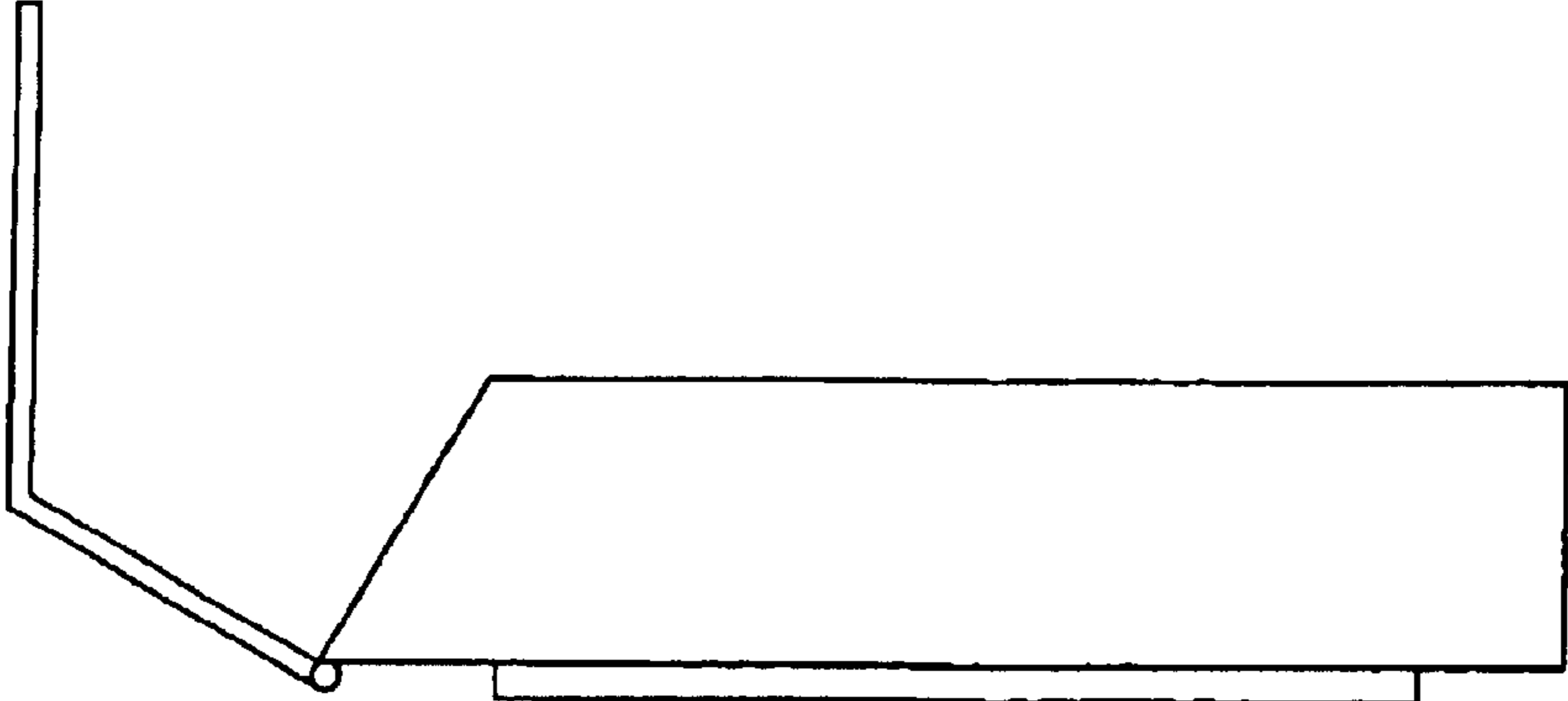

FIG. 3

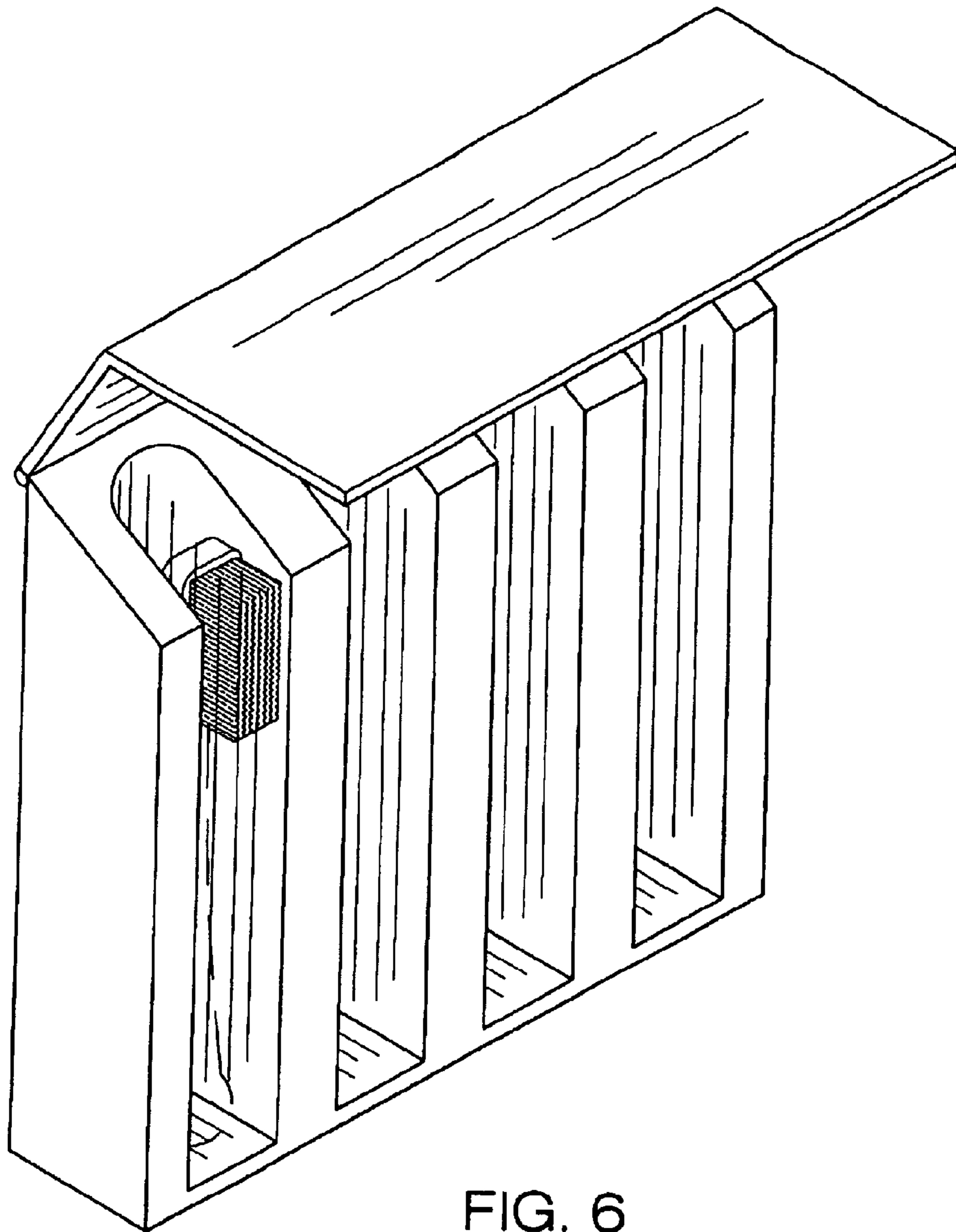

FIG. 6