



US00D511894S

(12) **United States Design Patent** (10) **Patent No.:** **US D511,894 S**  
**Janney, Jr. et al.** (45) **Date of Patent:** **\*\* Nov. 29, 2005**

(54) **PAINT CAN CARRIER**

D268,791 S 4/1983 Wood  
 4,998,696 A \* 3/1991 Desjardins ..... 220/737  
 5,415,277 A 5/1995 Berntsen  
 D364,039 S \* 11/1995 Kruger ..... D3/315  
 D381,562 S \* 7/1997 Westcott ..... D3/309

(76) Inventors: **Benjamin S. Janney, Jr.**, 407 Evans Ave., Willow Grove, PA (US) 19090;  
**Theresa M. Janney**, 407 Evans Ave., Willow Grove, PA (US) 19090

\* cited by examiner

(\*\*) Term: **14 Years**

*Primary Examiner*—Louis S. Zarfaz  
*Assistant Examiner*—Monica A Weingart  
 (74) *Attorney, Agent, or Firm*—Michael Crilly, Esq.

(21) Appl. No.: **29/196,869**

(22) Filed: **Jan. 6, 2004**

(57) **CLAIM**

(51) **LOC (8) Cl.** ..... **03-01**

The ornamental design for a paint can carrier, as shown and described.

(52) **U.S. Cl.** ..... **D3/315**

(58) **Field of Search** ..... D3/309, 315, 316,  
 D3/317; D7/706; D9/760; D19/35, 75;  
 206/144, 167, 429, 203, 510, 445, 0.83,  
 515, 493, 373, 576; 211/74; 217/19, 21;  
 220/737, 759, 522, 761; 224/148.7, 629,  
 633; 248/210, 246

**DESCRIPTION**

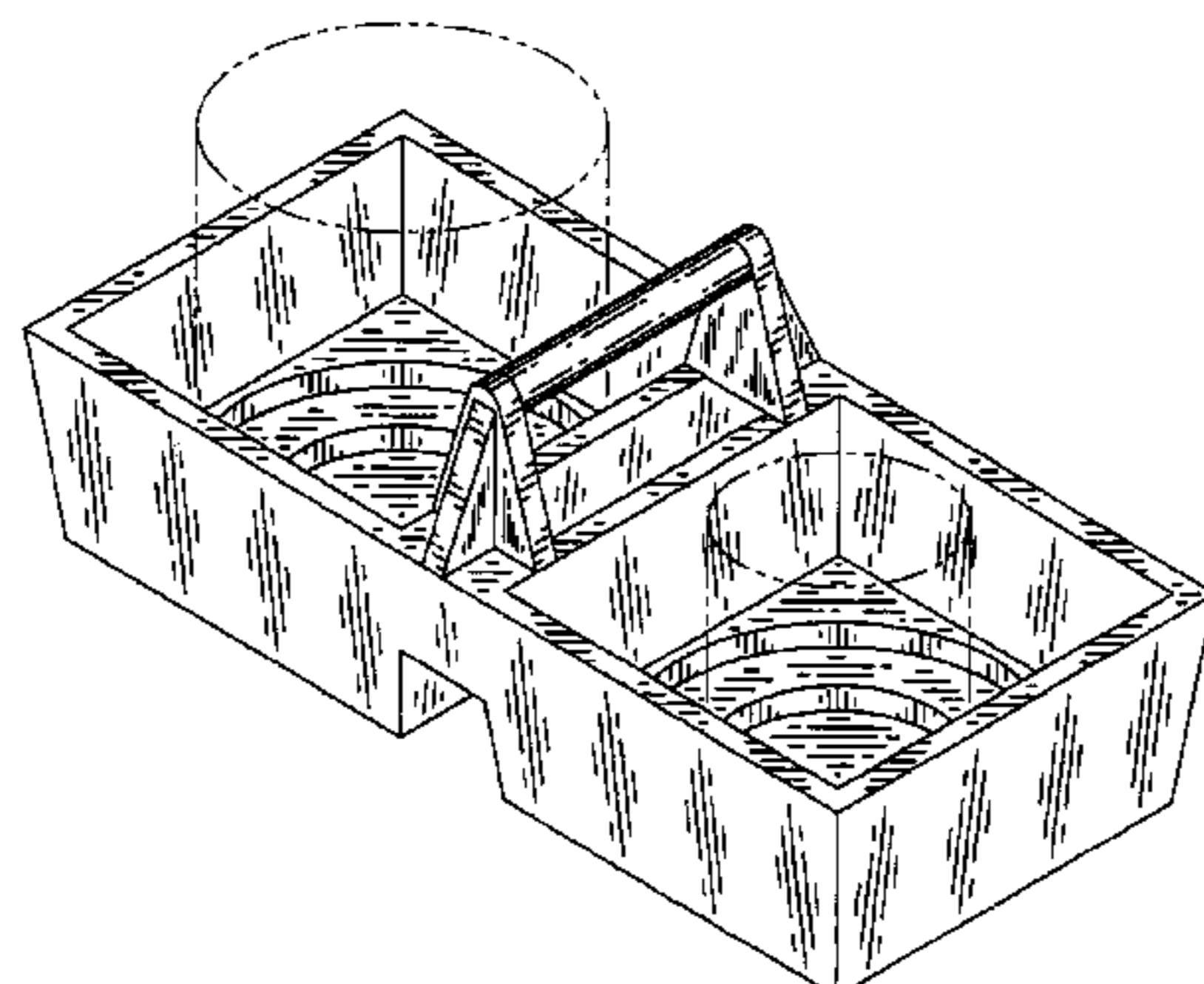
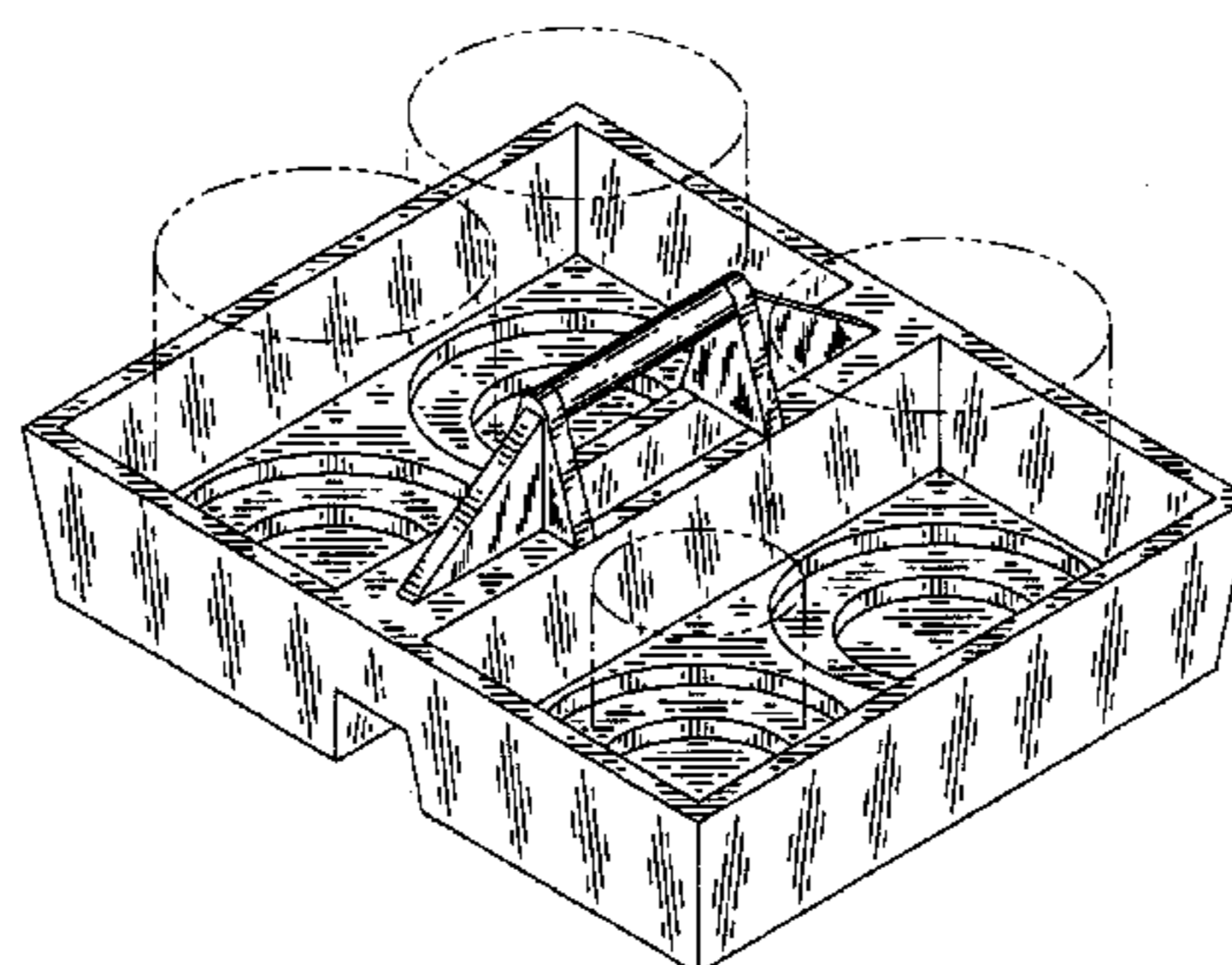
FIG. 1 is a front perspective view of a paint can carrier showing our new design;  
 FIG. 2 is a front elevational view thereof;  
 FIG. 3 is a left side elevational view, the right side being identical thereof;  
 FIG. 4 is a bottom plan view thereof;  
 FIG. 5 is a top plan view thereof;  
 FIG. 6 is a front perspective view of a second embodiment thereof;  
 FIG. 7 is a front elevational view thereof;  
 FIG. 8 is a left side elevational view, the right side being identical thereof;  
 FIG. 9 is a bottom plan view thereof; and,  
 FIG. 10 is a top plan view thereof.  
 The broken line showing of paint cans, in FIGS. 1 and 6, is for illustrative purposes only and forms no part of the claimed design.

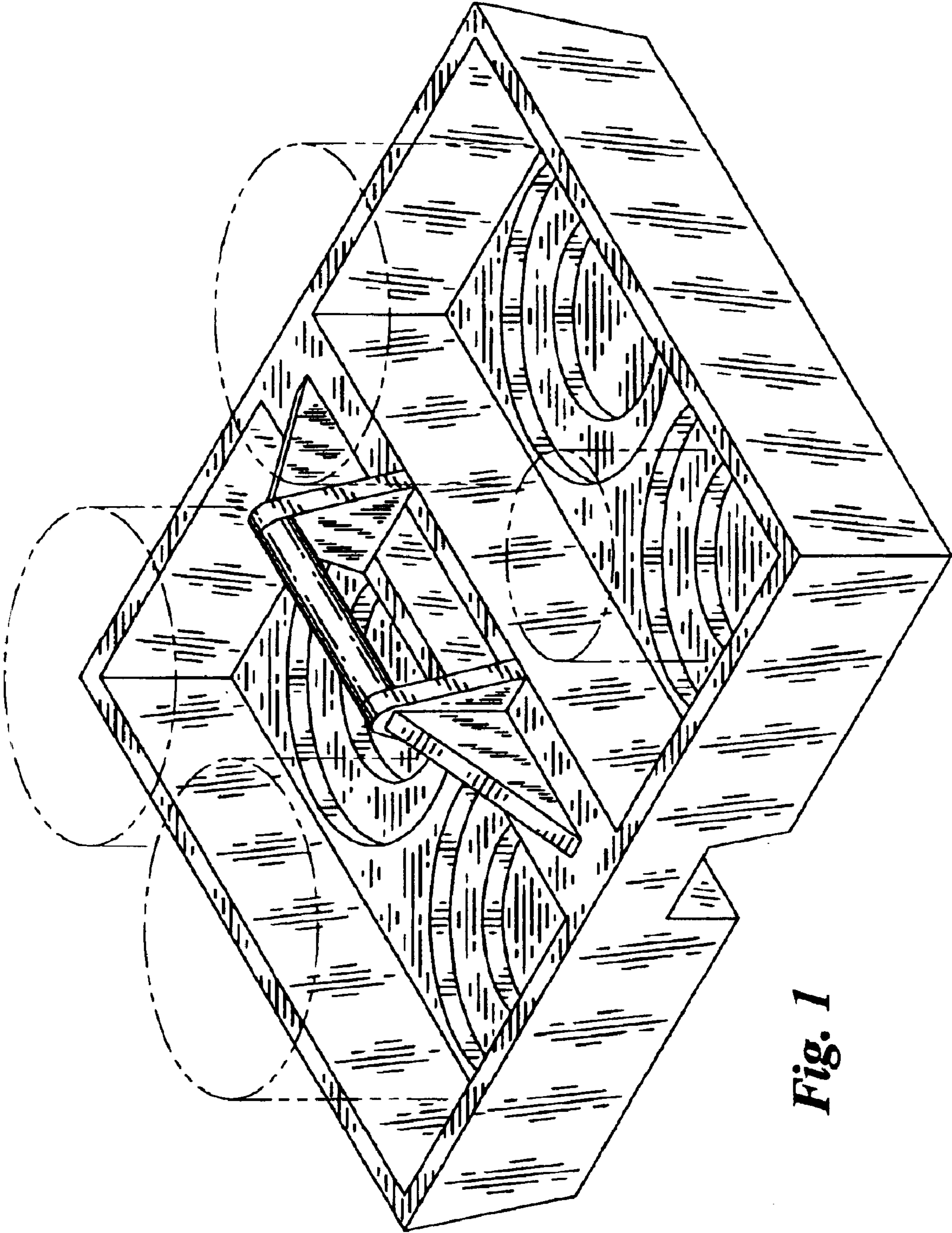
(56) **References Cited**

**U.S. PATENT DOCUMENTS**

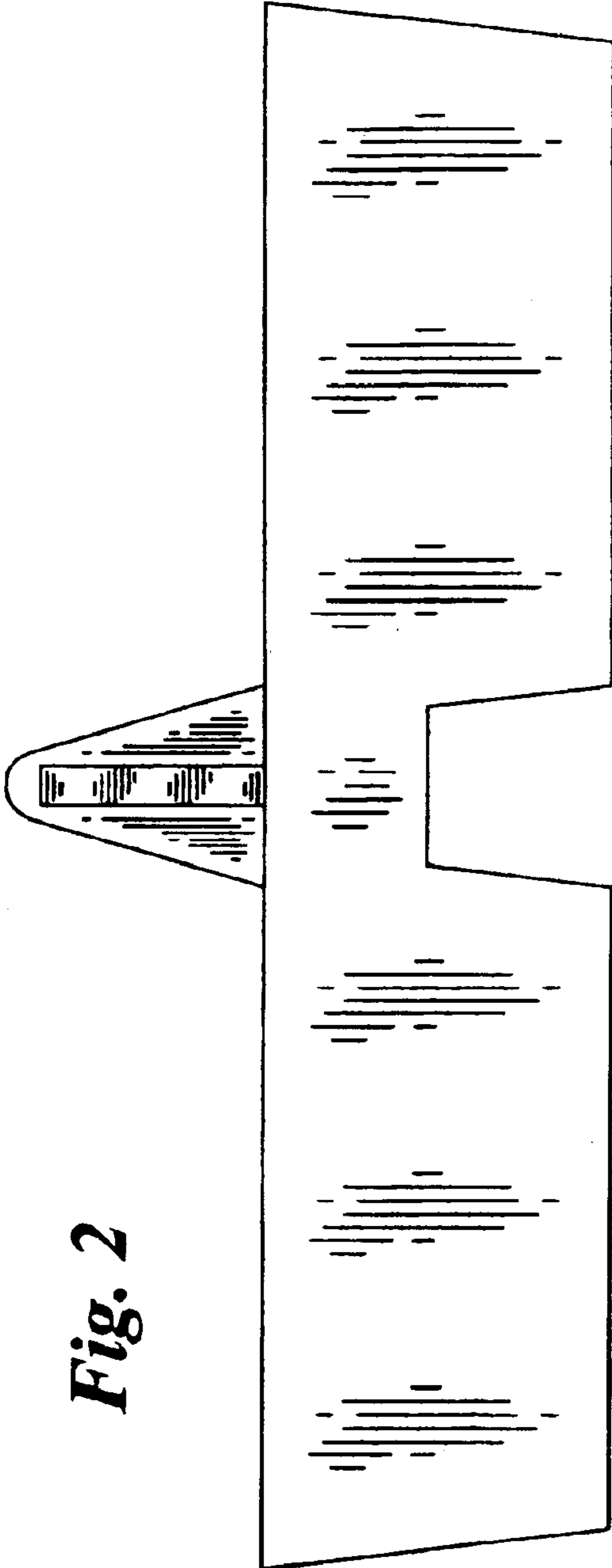
768,364 A \* 8/1904 Hines ..... 248/210  
 D142,783 S 11/1945 Jacobson  
 D193,313 S 7/1962 Peca  
 3,281,010 A \* 10/1966 Moore et al. .... 206/203  
 3,625,393 A \* 12/1971 Mittel ..... 206/203  
 4,040,517 A 8/1977 Torokvei  
 D246,633 S 12/1977 Torokvei  
 4,071,162 A 1/1978 Steinlein et al.  
 4,143,765 A 3/1979 Moss, III  
 D256,434 S 8/1980 O'Donnal  
 4,234,114 A 11/1980 Wood  
 D265,010 S 6/1982 Wood  
 4,342,388 A 8/1982 Torokvei

**1 Claim, 8 Drawing Sheets**

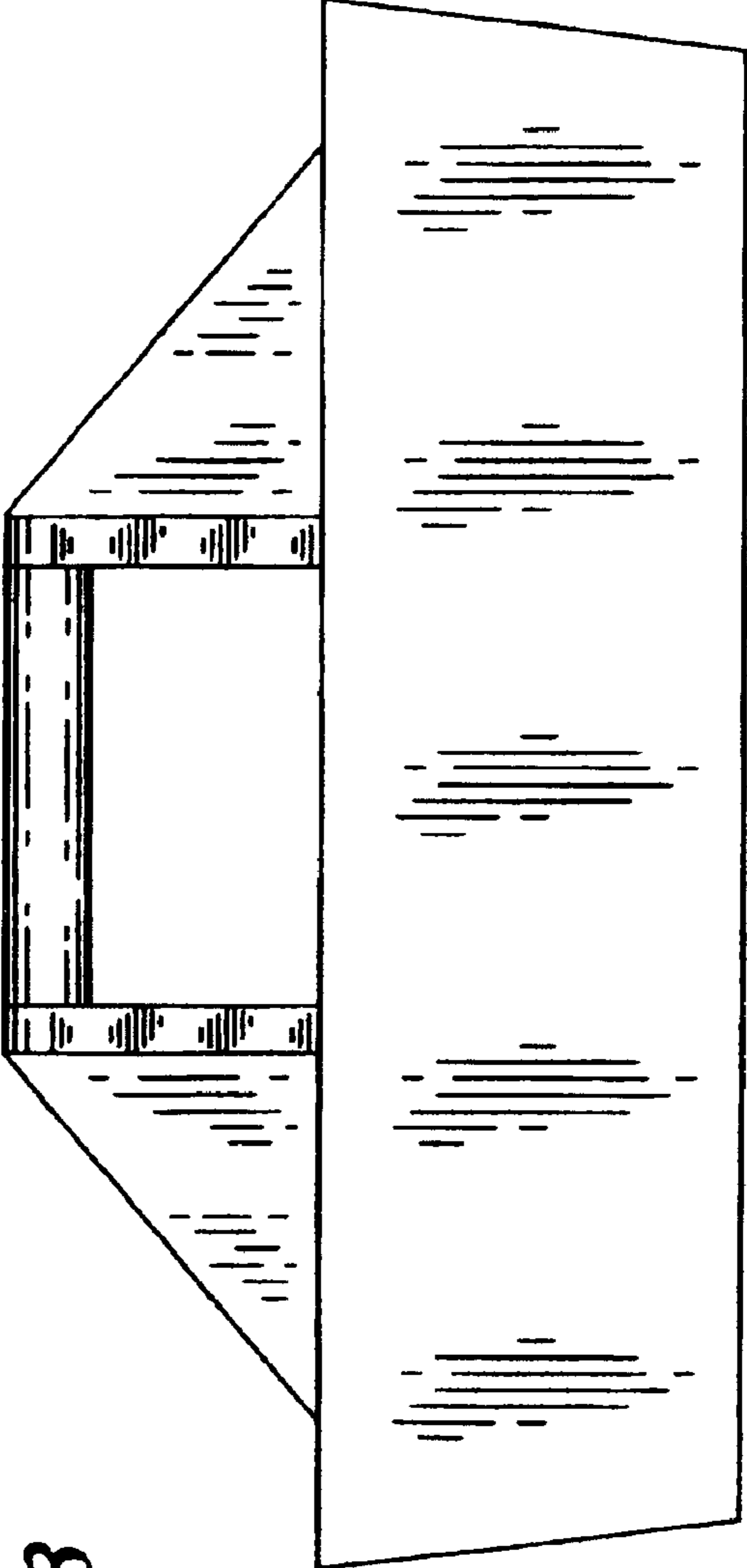




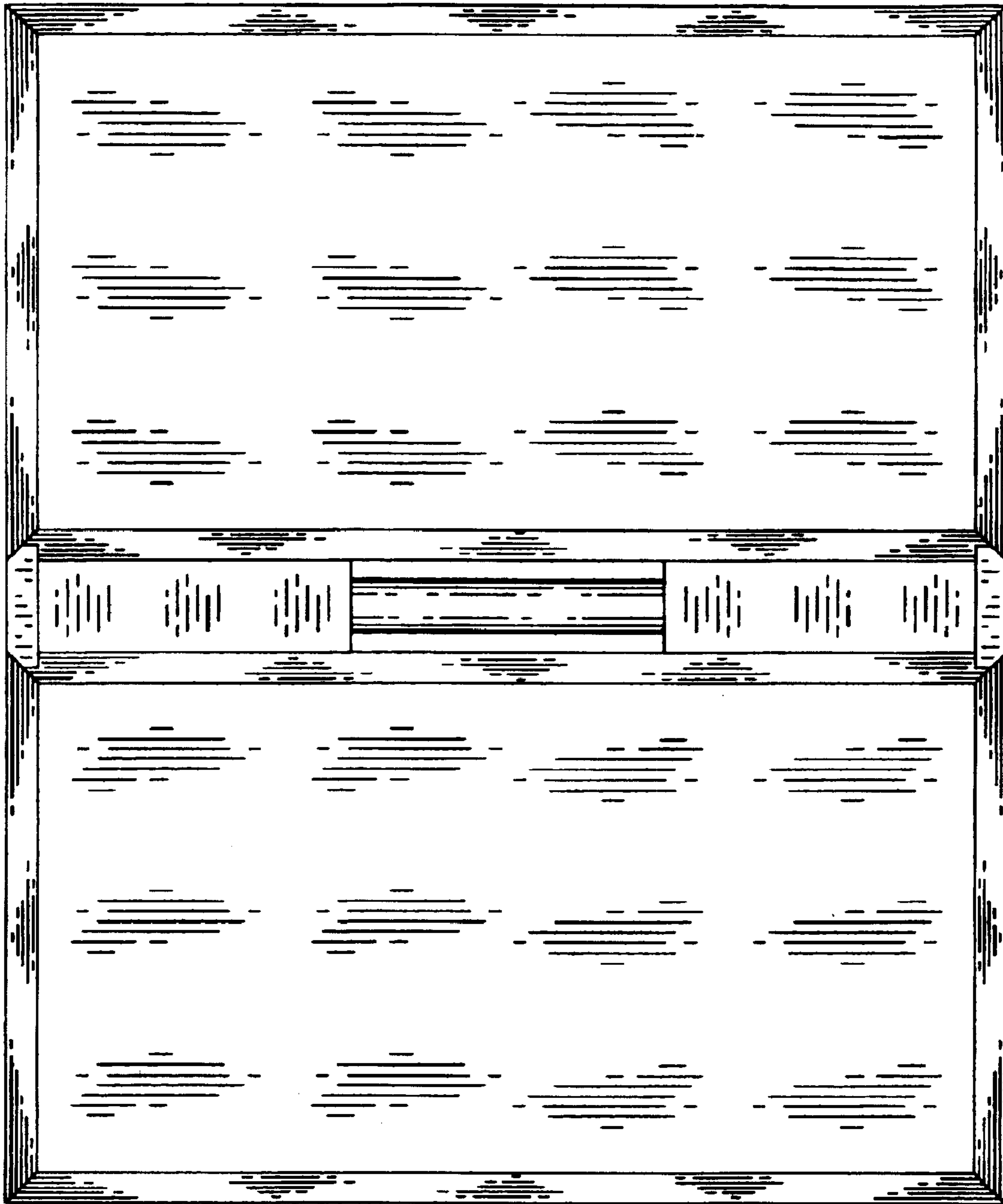
**Fig. 1**



*Fig. 2*



*Fig. 3*



*Fig. 4*



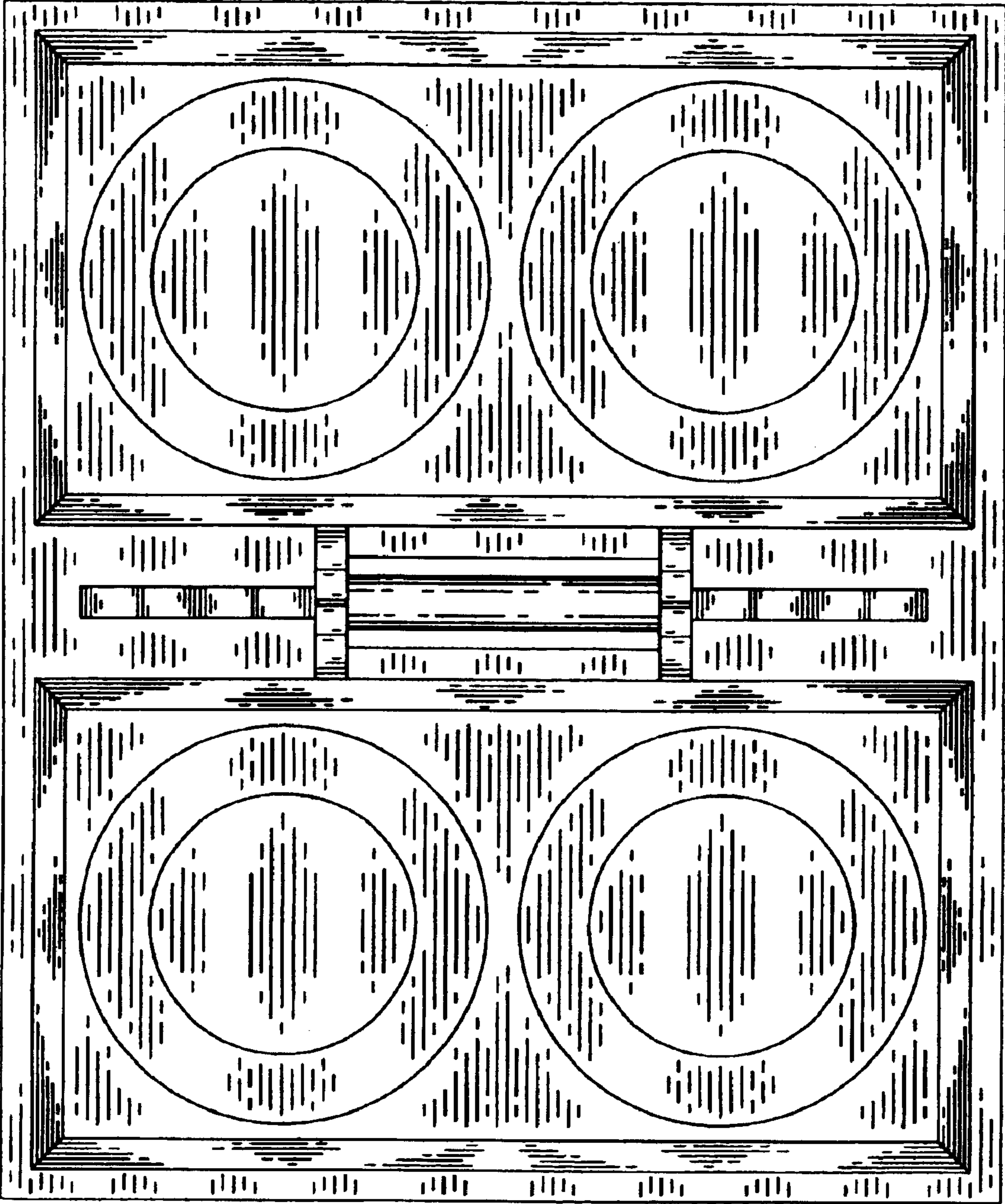
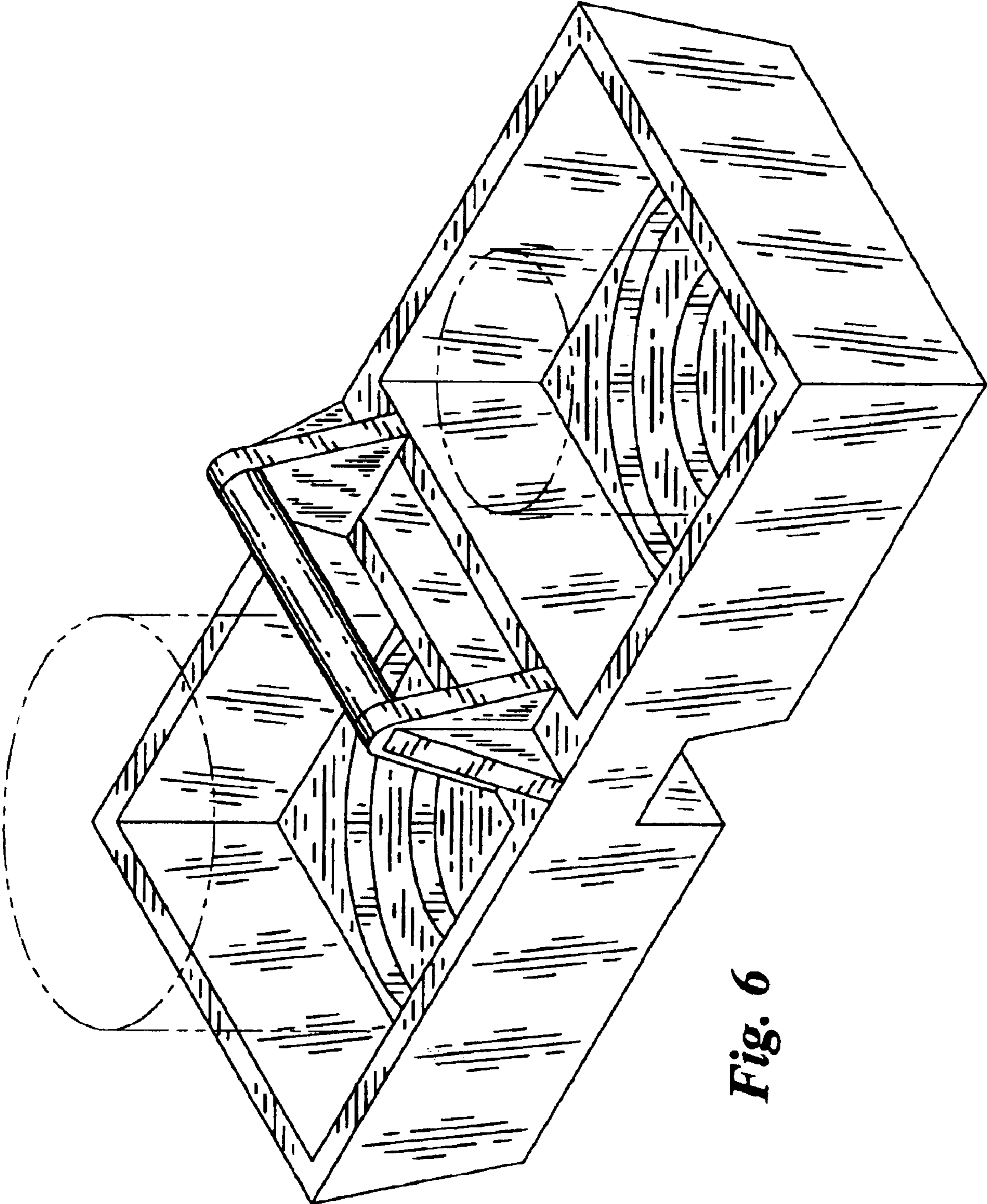
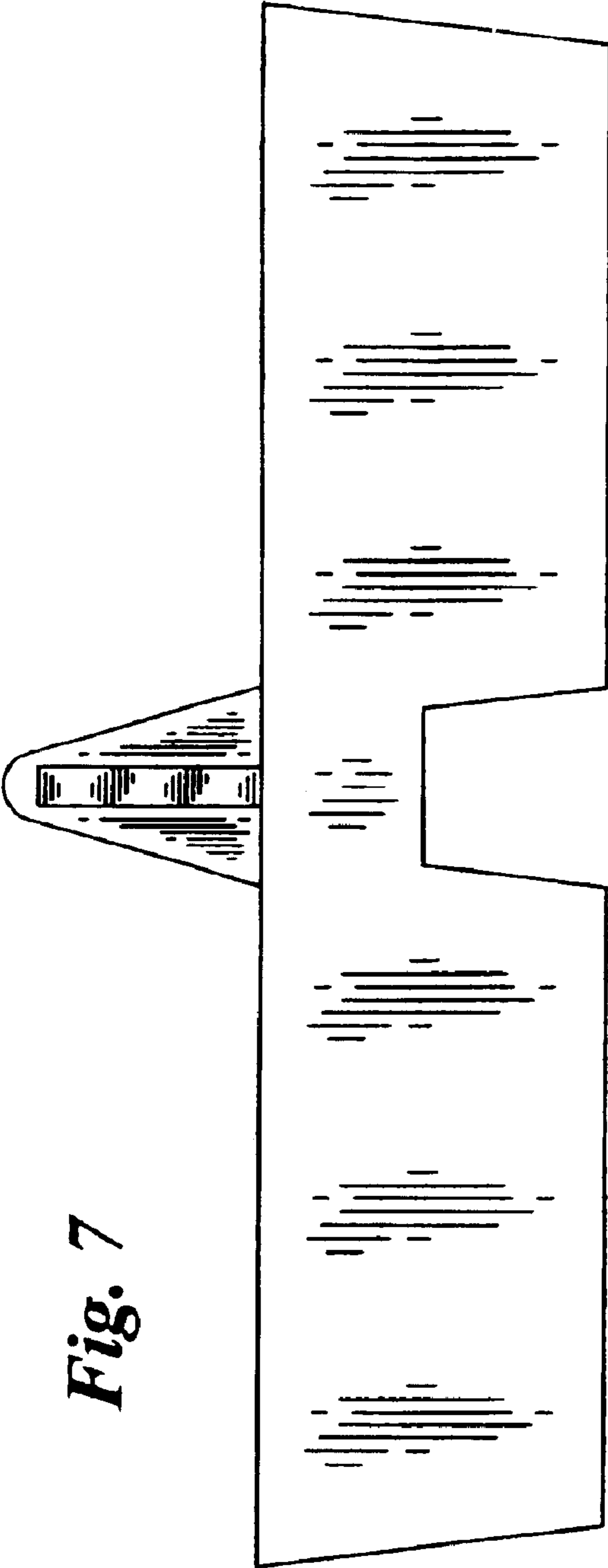


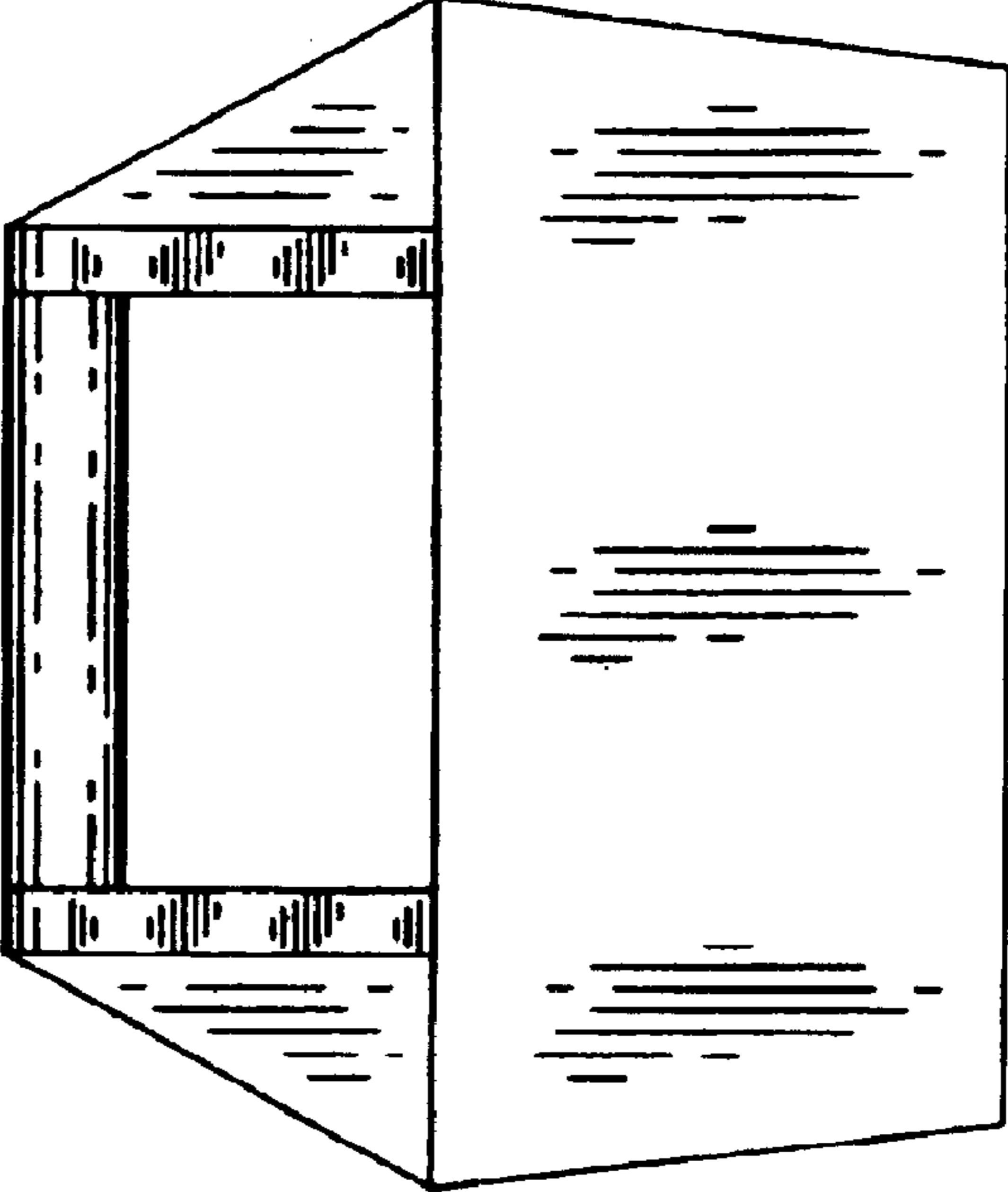
Fig. 5



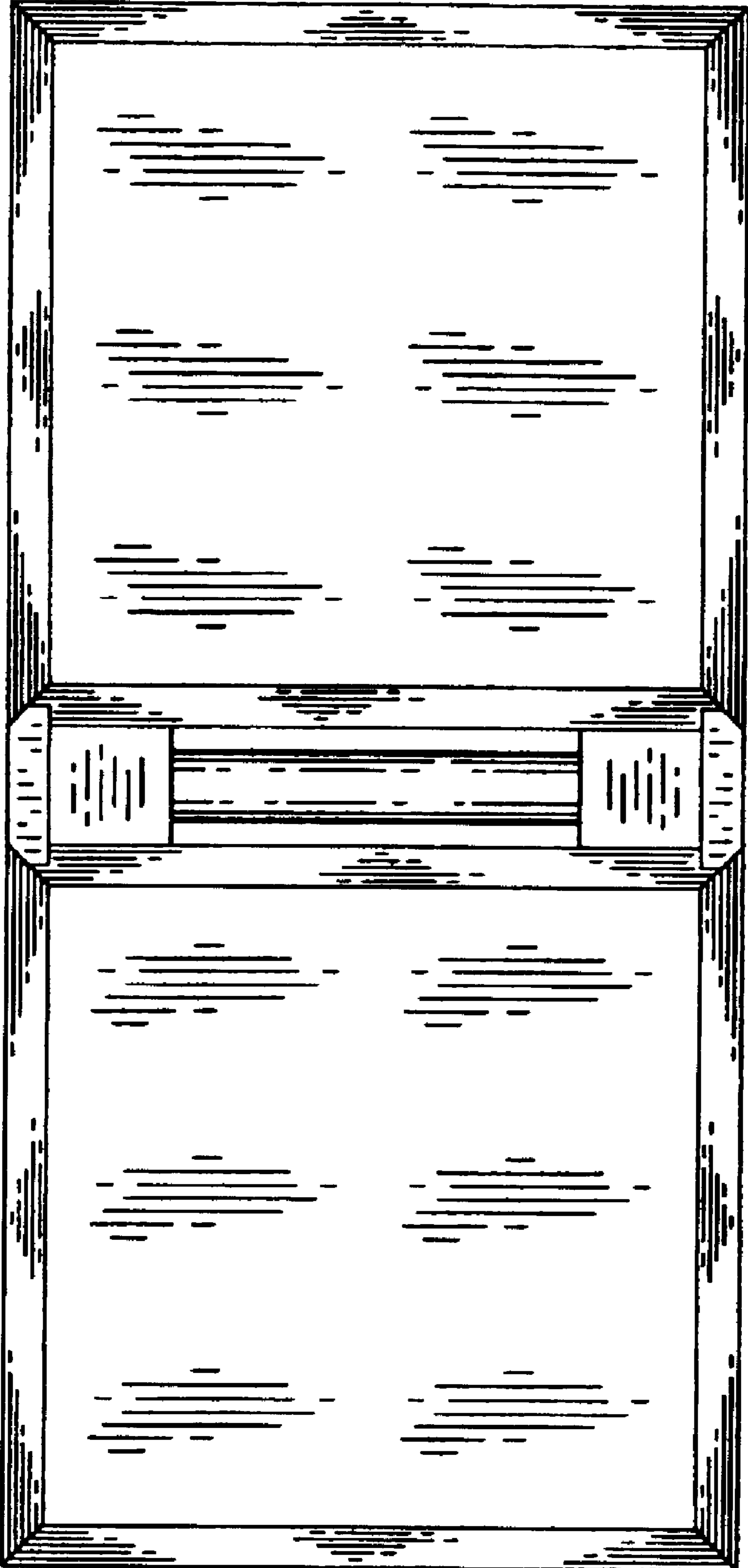
*Fig. 6*



*Fig. 7*

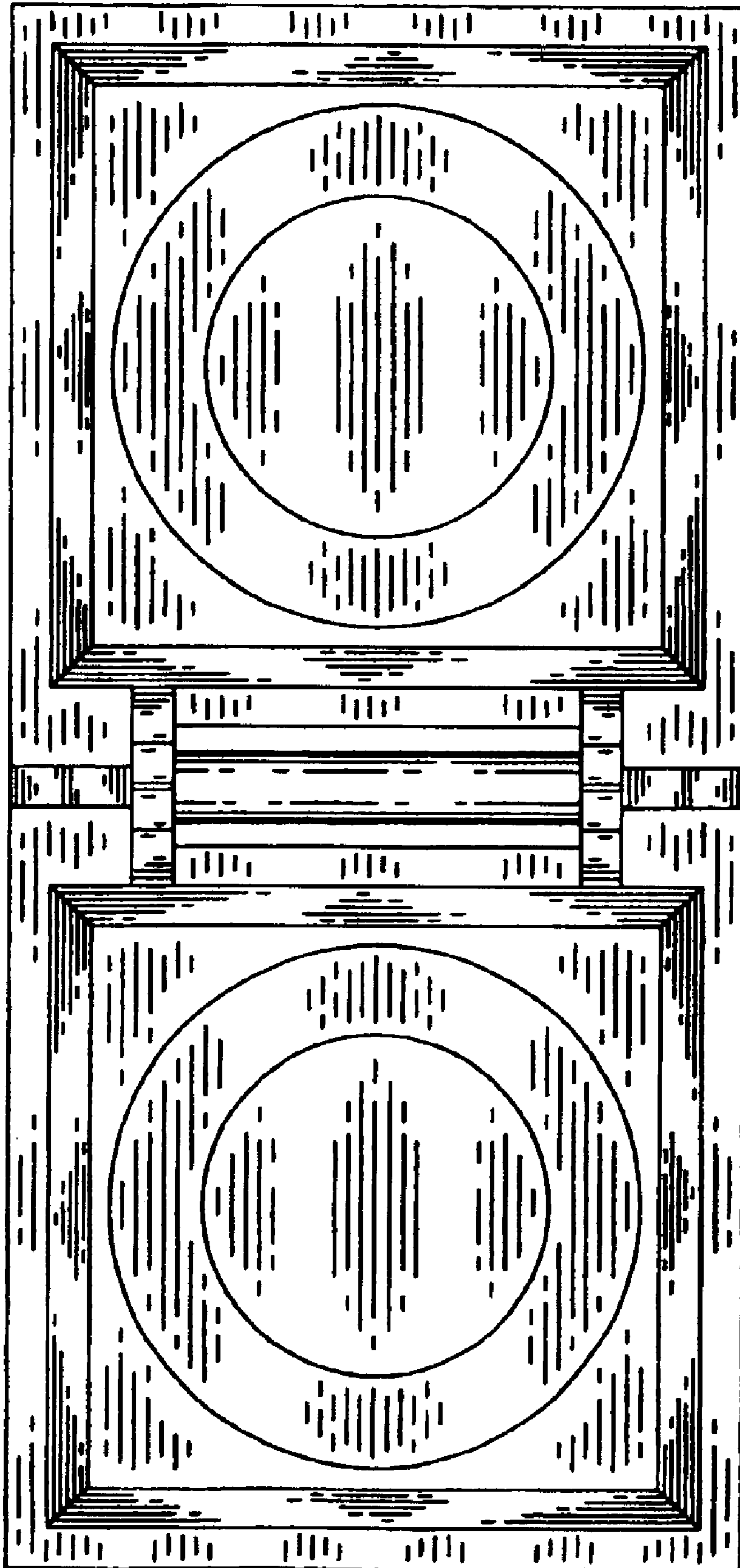


*Fig. 8*



*Fig. 9*





*Fig. 10*