

US00D511842S

(12) **United States Design Patent**
Kim

(10) **Patent No.:** **US D511,842 S**

(45) **Date of Patent:** **** Nov. 22, 2005**

(54) **WINDOW FRAME MEMBER**

(75) Inventor: **Seong-Joong Kim**, Cheongju (KR)

(73) Assignee: **LG CHem, Ltd.**, Seoul (KR)

(**) Term: **14 Years**

(21) Appl. No.: **29/200,503**

(22) Filed: **Feb. 26, 2004**

(30) **Foreign Application Priority Data**

Aug. 26, 2003 (KR) 30-2003-0024189

(51) **LOC (8) Cl.** **25-02**

(52) **U.S. Cl.** **D25/60**

(58) **Field of Search** D25/60, 124; 49/504,
49/DIG. 2; 52/204.5, 204.595, 204.71

(56) **References Cited**

U.S. PATENT DOCUMENTS

D174,156 S * 3/1955 Blanchard D25/125

D363,135 S * 10/1995 Franson D25/124

* cited by examiner

Primary Examiner—Doris Clark

(74) *Attorney, Agent, or Firm*—Ladas & Parry LLP

(57) **CLAIM**

The ornamental design for a window frame member, as shown and described.

DESCRIPTION

FIG. 1 is a perspective view of the window frame member; FIG. 2 is a front view of the window frame member of FIG. 1;

FIG. 3 is a rear view of the window frame member of FIG. 1;

FIG. 4 is a left side view of the window frame member of FIG. 1;

FIG. 5 is a right side view of the window frame member of FIG. 1;

FIG. 6 is a top view of the window frame member of FIG. 1; and,

FIG. 7 is bottom view of the window frame member of FIG. 1.

The surface(s) or portion(s) of the article not shown in the drawing or described in the specification form(s) no part of the claimed design.

1 Claim, 5 Drawing Sheets

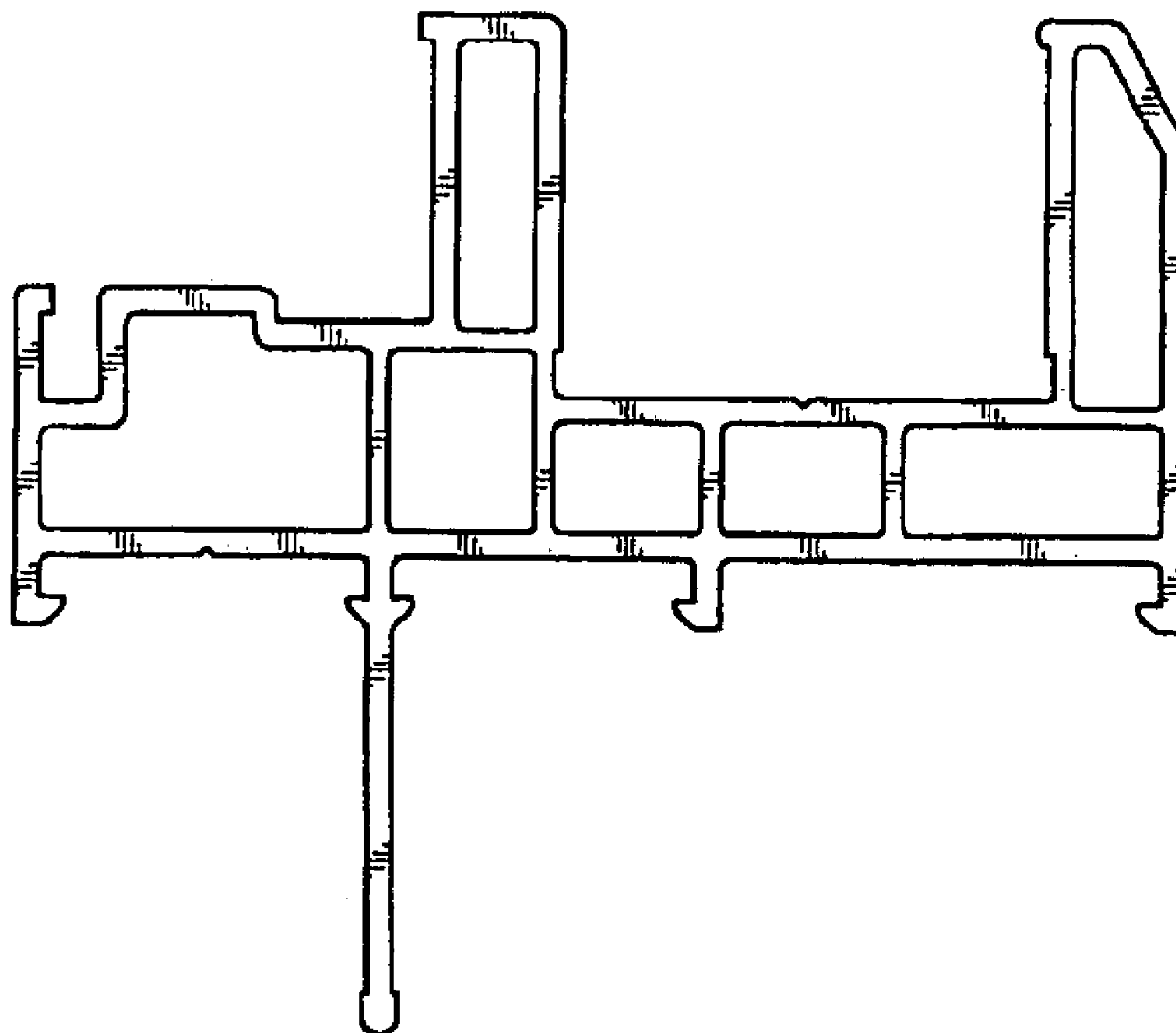

FIG. 1

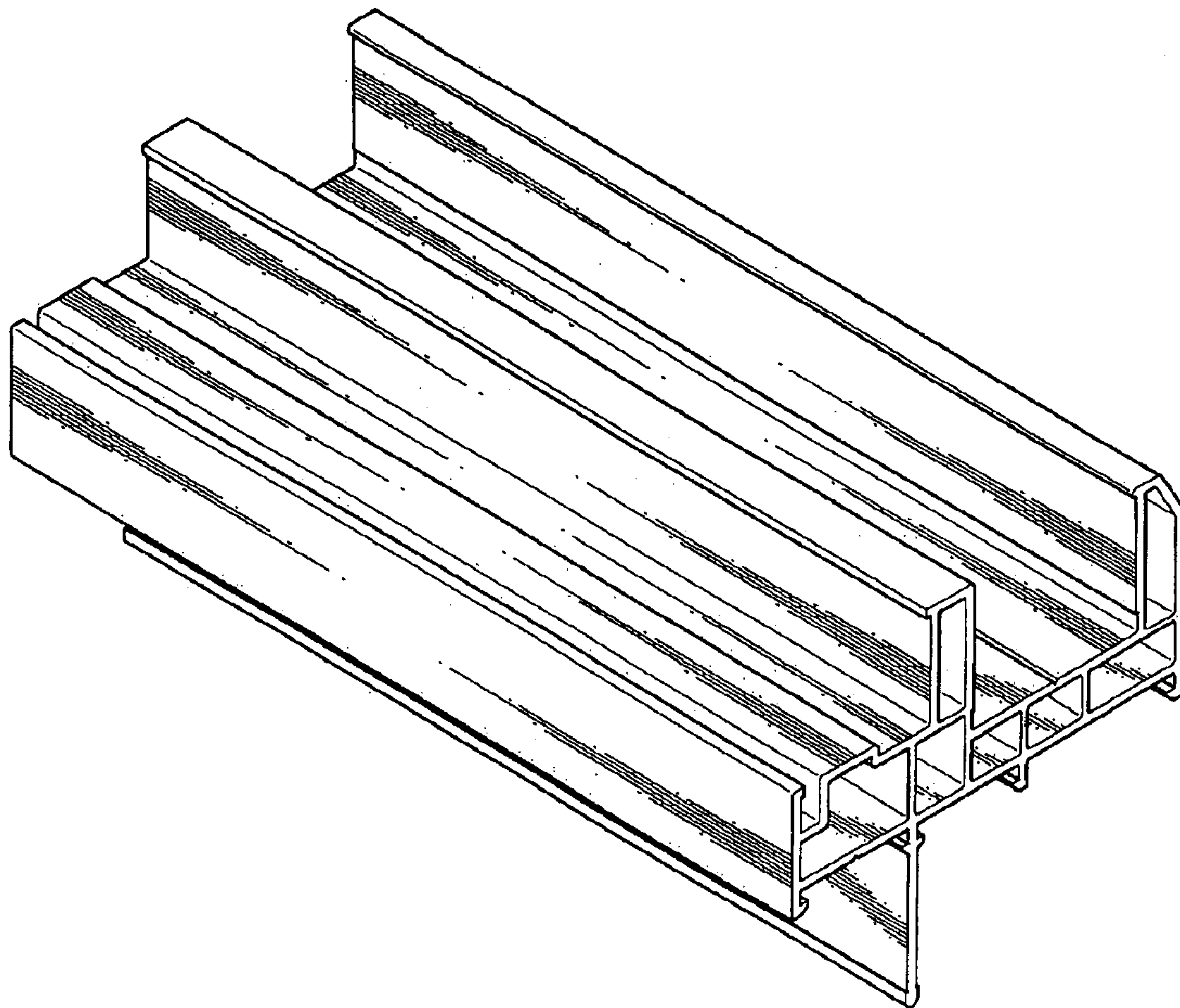

FIG. 2

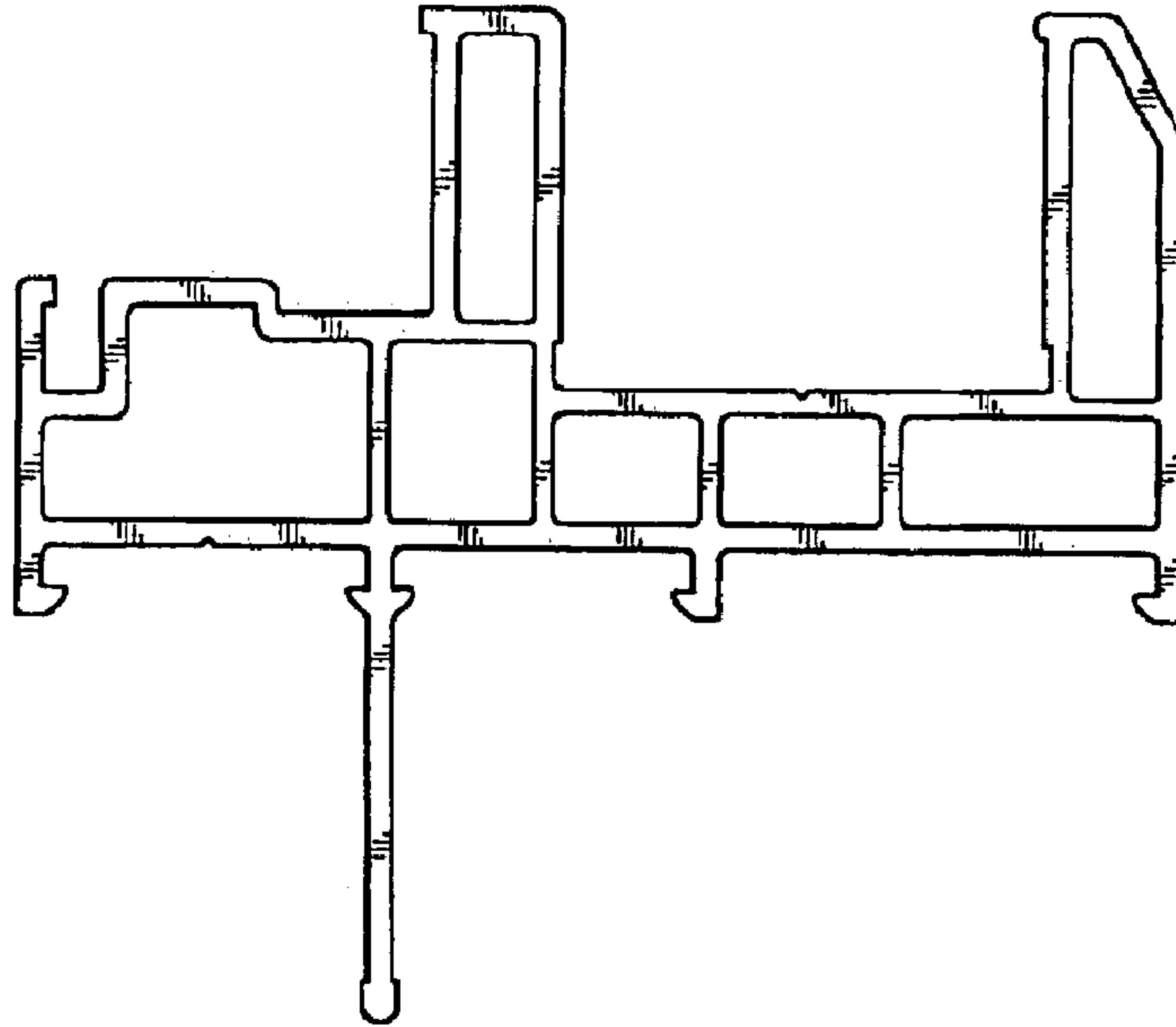

FIG. 3

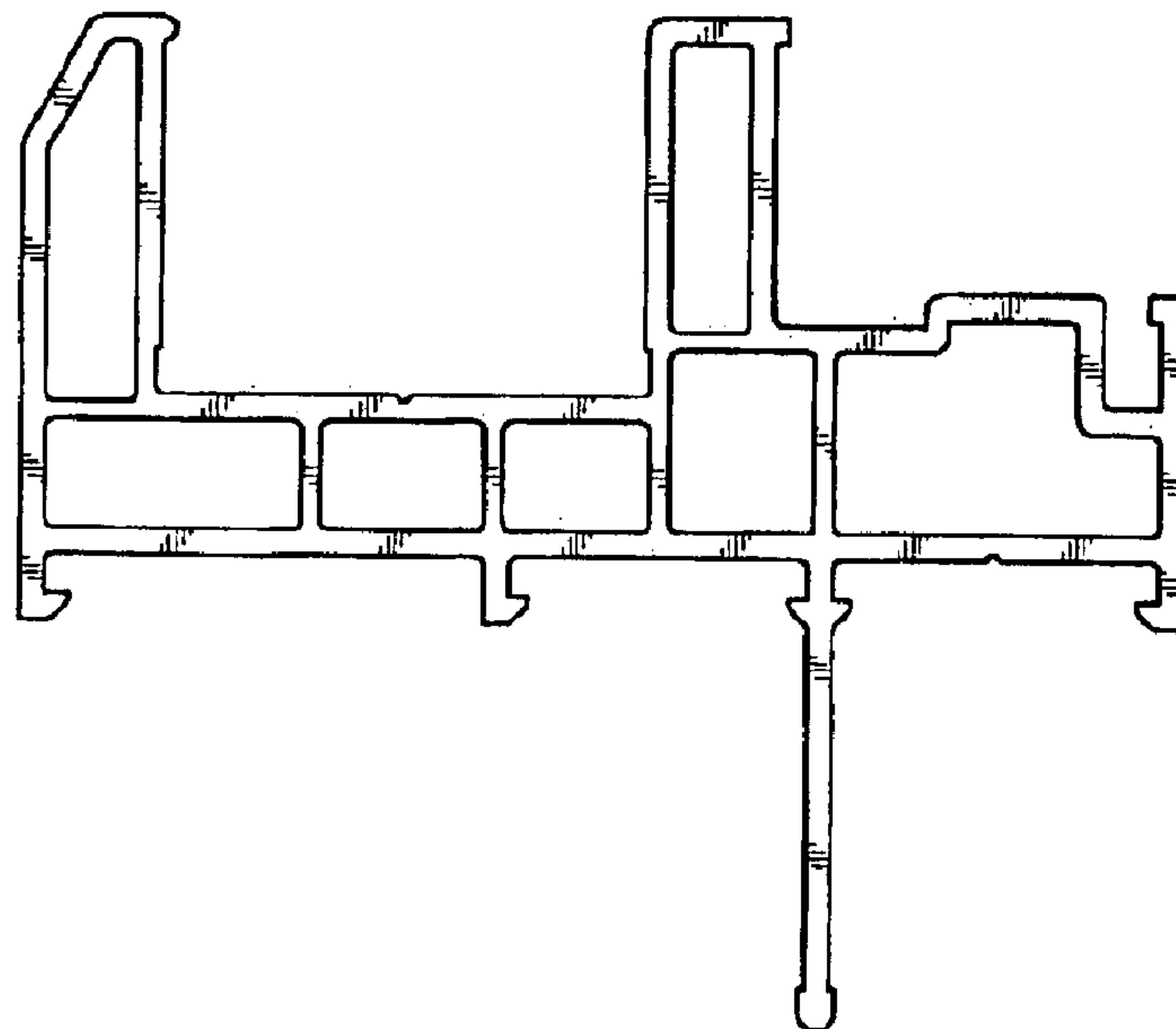

FIG. 4

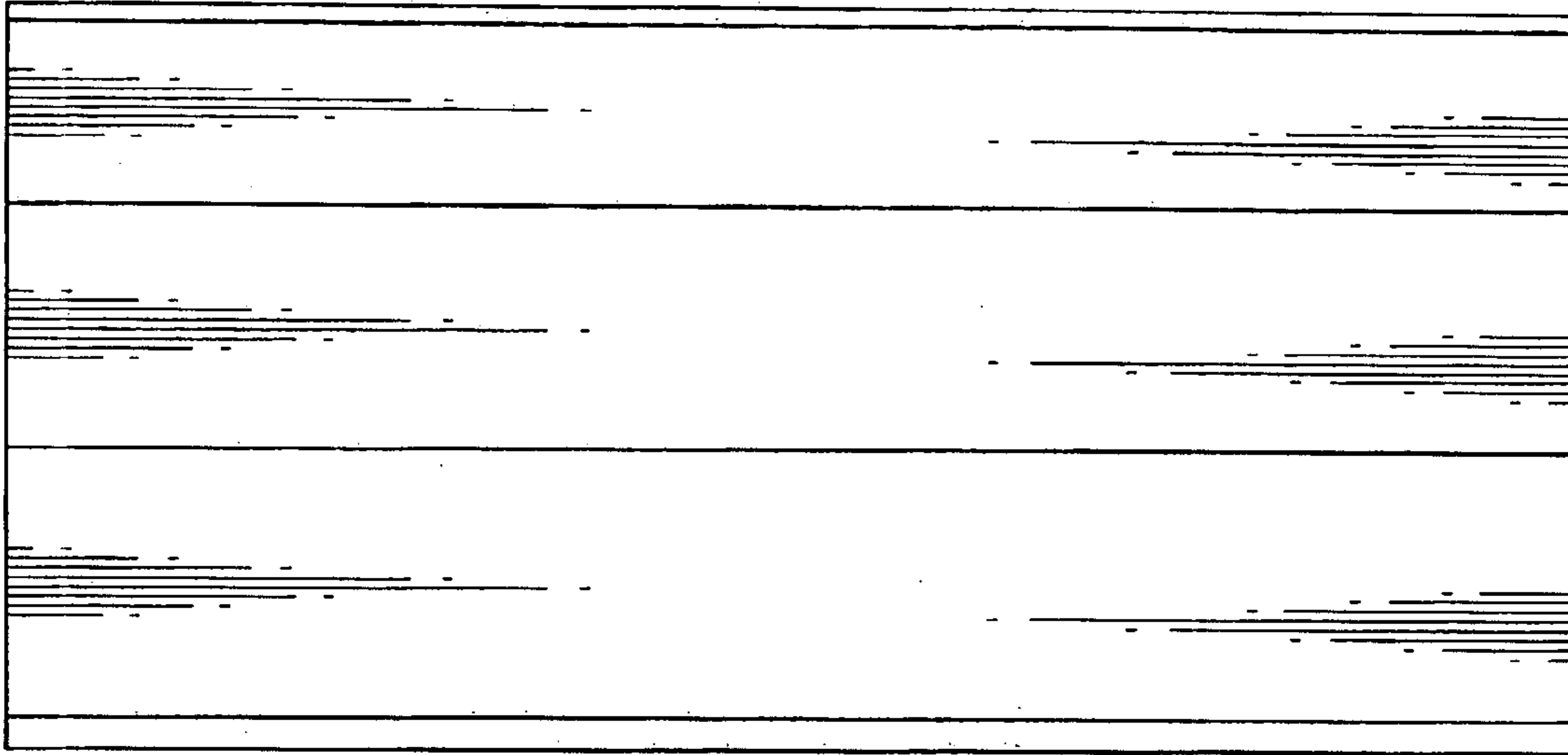

FIG. 5

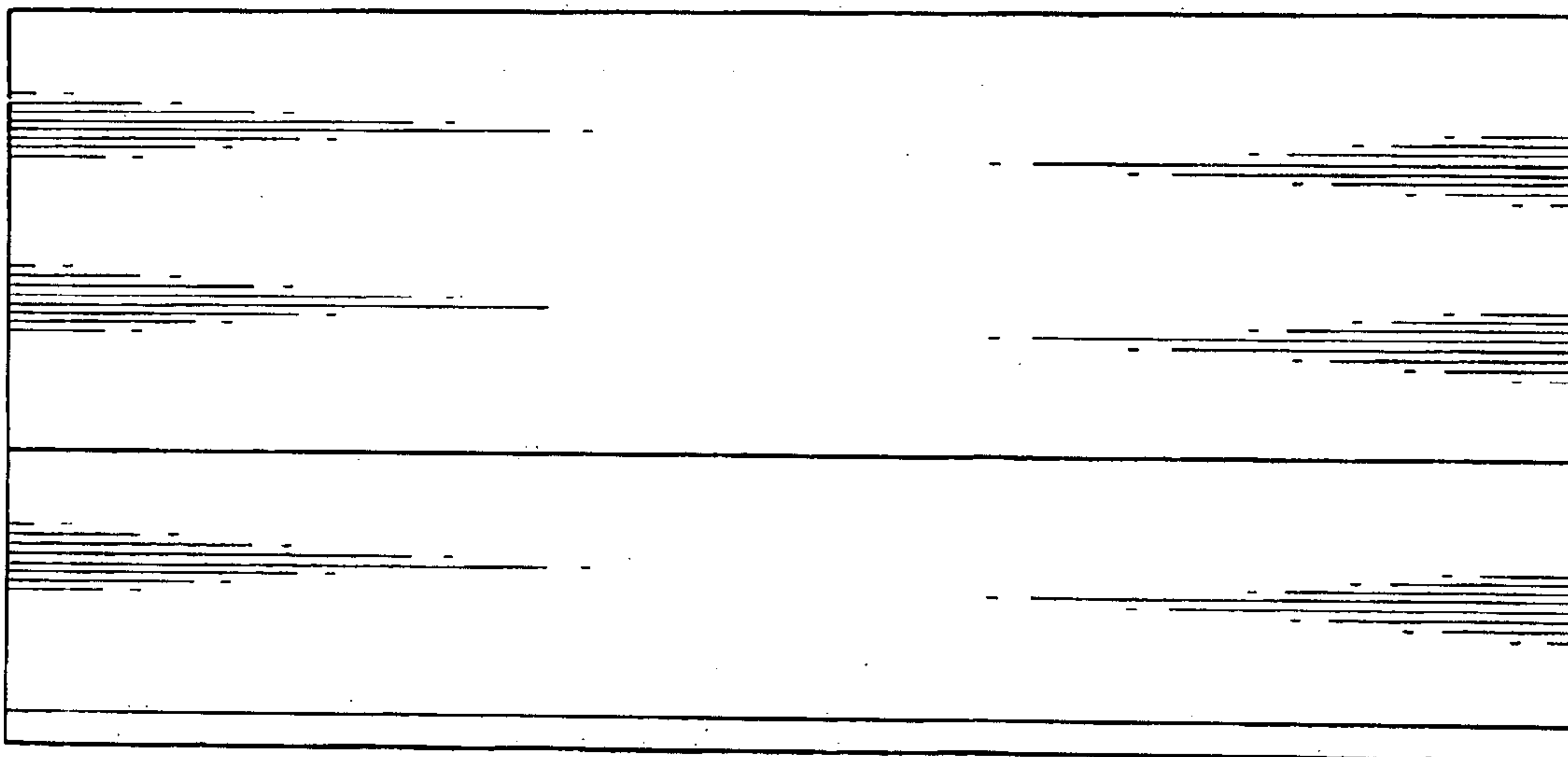

FIG. 6

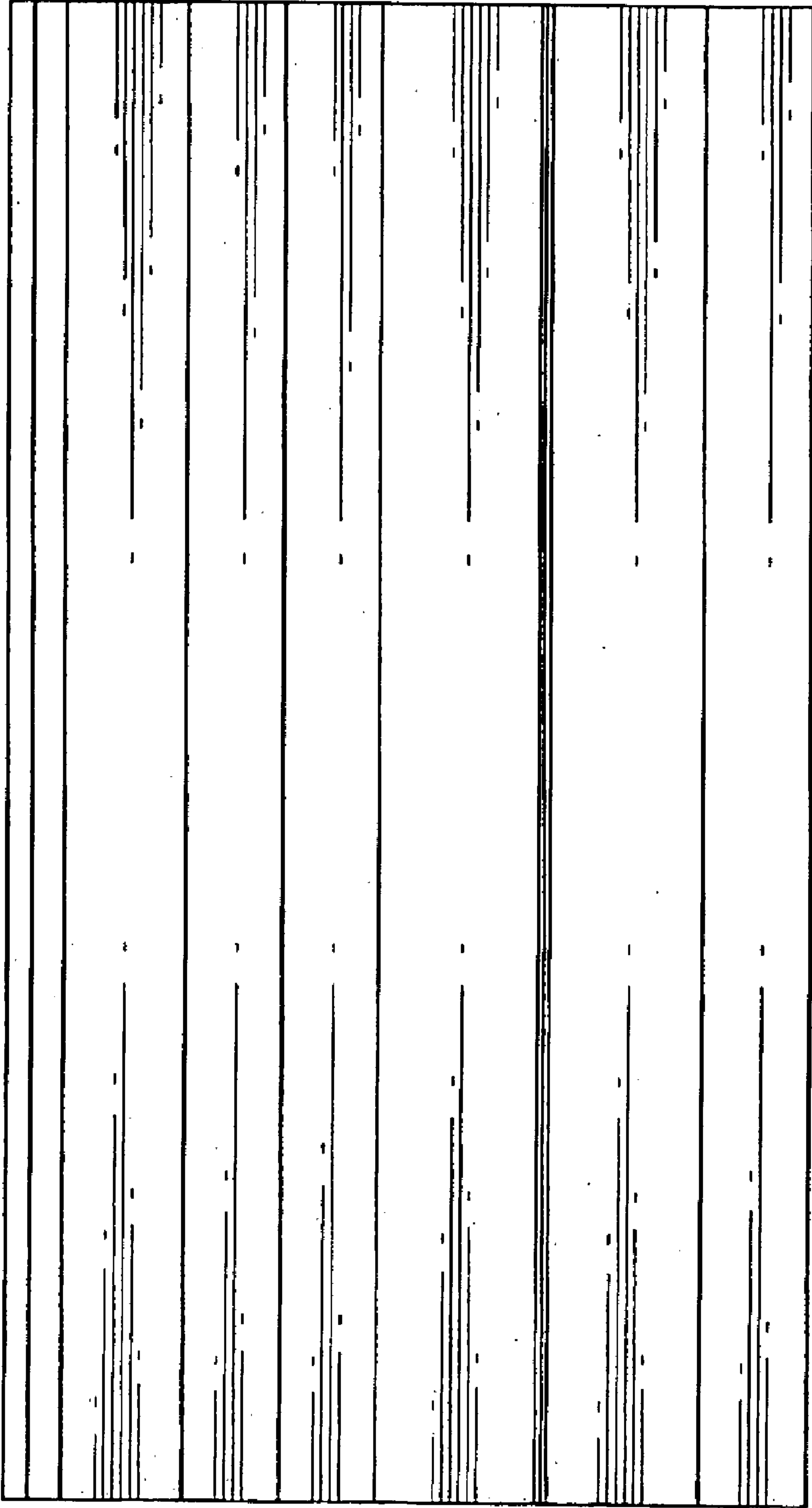

FIG. 7

