



US00D511829S

(12) **United States Design Patent**
Phipps et al.

(10) **Patent No.:** **US D511,829 S**
(45) **Date of Patent:** **** Nov. 22, 2005**

- (54) **TAMPON APPLICATOR BARREL**
- (75) Inventors: **Troy Phipps**, Brooklyn, NY (US);
Susanne Weber, New York, NY (US)
- (73) Assignee: **Playtex Products, Inc.**, Westport, CT (US)
- (**) Term: **14 Years**
- (21) Appl. No.: **29/201,274**
- (22) Filed: **Mar. 12, 2004**
- (51) **LOC (8) Cl.** **24-02**
- (52) **U.S. Cl.** **D24/141**
- (58) **Field of Search** D24/141, 135;
604/15, 902, 18, 17, 11, 16; 606/191

(56) **References Cited**

U.S. PATENT DOCUMENTS

3,628,533 A	12/1971	Loyer	128/263
D250,663 S	12/1978	Koch et al.	D24/141
4,508,531 A	4/1985	Whitehead	604/14
4,536,178 A	8/1985	Lichstein et al.	604/15
D415,565 S	* 10/1999	Hayes et al.	D24/141
D492,033 S	* 6/2004	Jarmon et al.	D24/141
2004/0054317 A1	* 3/2004	Lemay et al.	604/15

* cited by examiner

Primary Examiner—Ian Simmons
(74) *Attorney, Agent, or Firm*—Ohlandt, Greeley, Ruggiero & Perle, L.L.P.

(57) **CLAIM**

The ornamental design for the tampon applicator barrel, as shown and described.

DESCRIPTION

FIG. 1 is a front perspective view of a tampon applicator barrel according to the present invention;

FIG. 2 is a rear perspective view of the tampon applicator barrel of FIG. 1;

FIG. 3 is a top view of the tampon applicator barrel of FIG. 1;

FIG. 4 is the tampon applicator barrel of FIG. 3 rotated by 90 degrees about a longitudinal axis of the tampon applicator barrel;

FIG. 5 is a front end view of the tampon applicator barrel of FIG. 1; and,

FIG. 6 is a rear end view of the tampon applicator barrel of FIG. 1.

The broken line showing is for illustrative purposes only and forms no part of the claimed design.

1 Claim, 4 Drawing Sheets

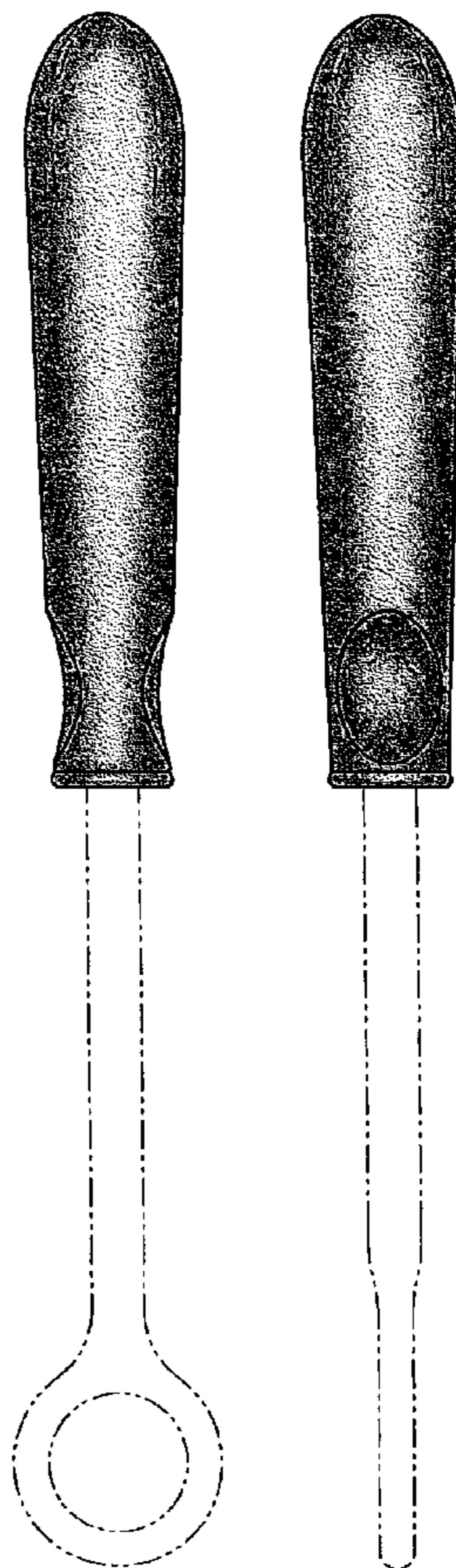

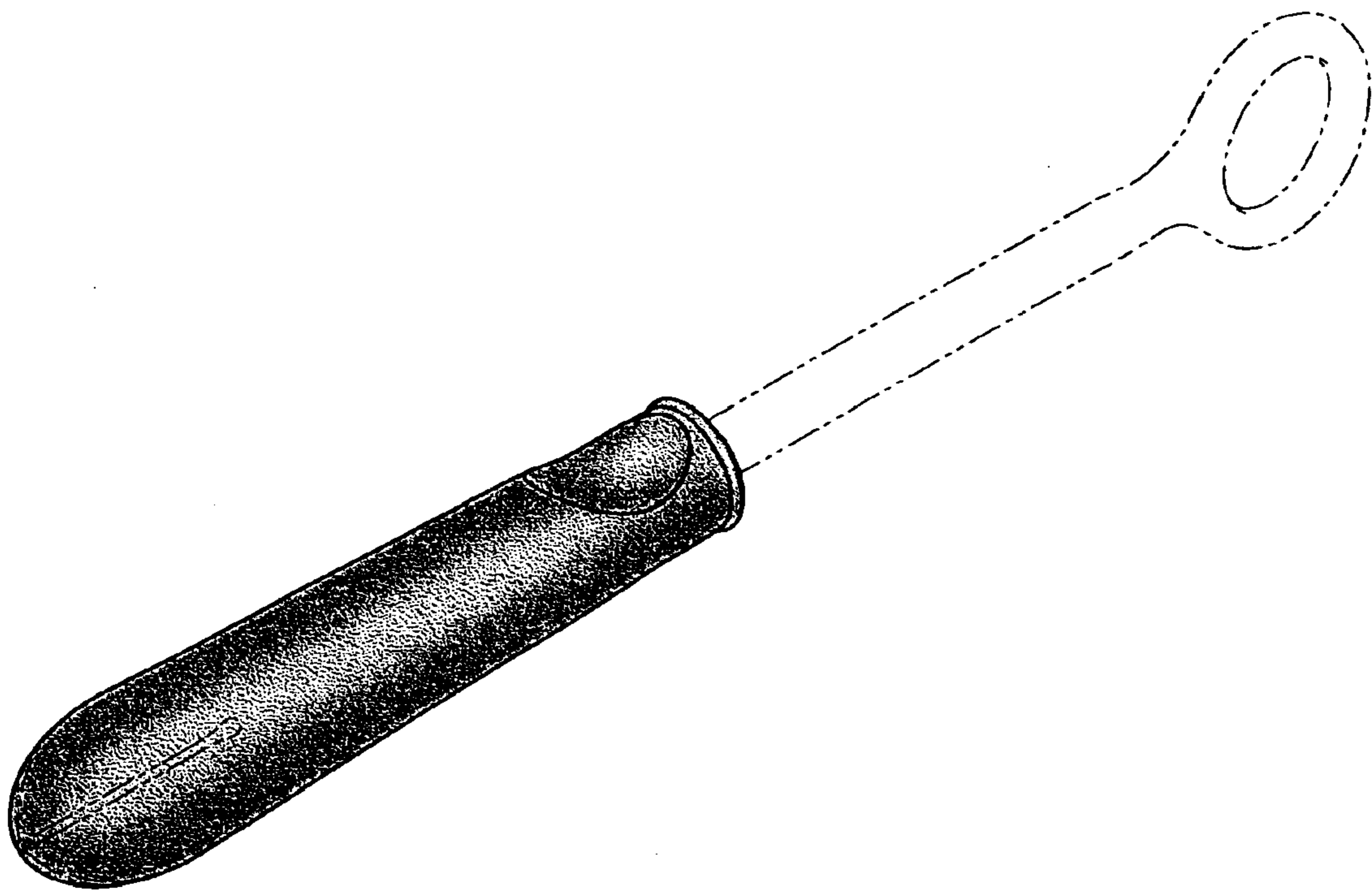

FIG. 1

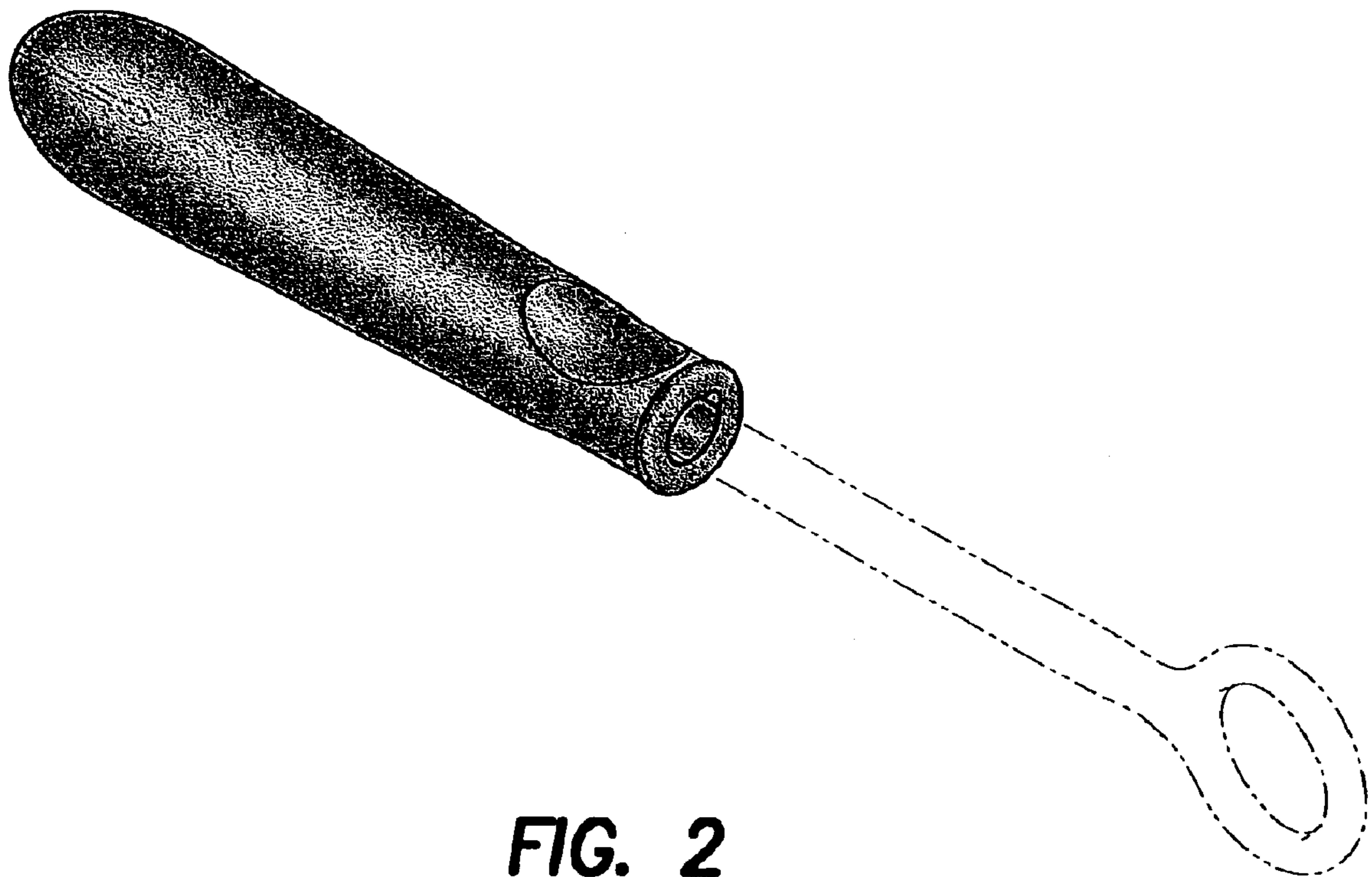

FIG. 2

FIG. 3

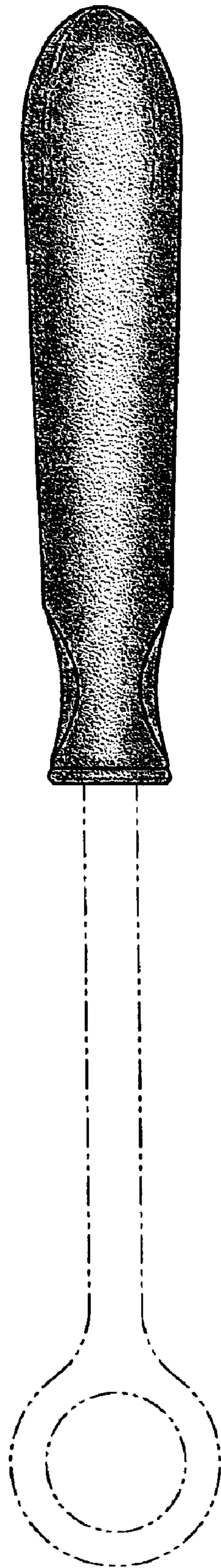
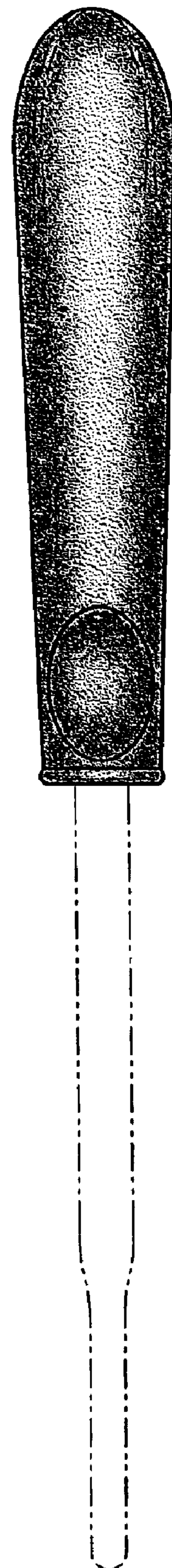

FIG. 4



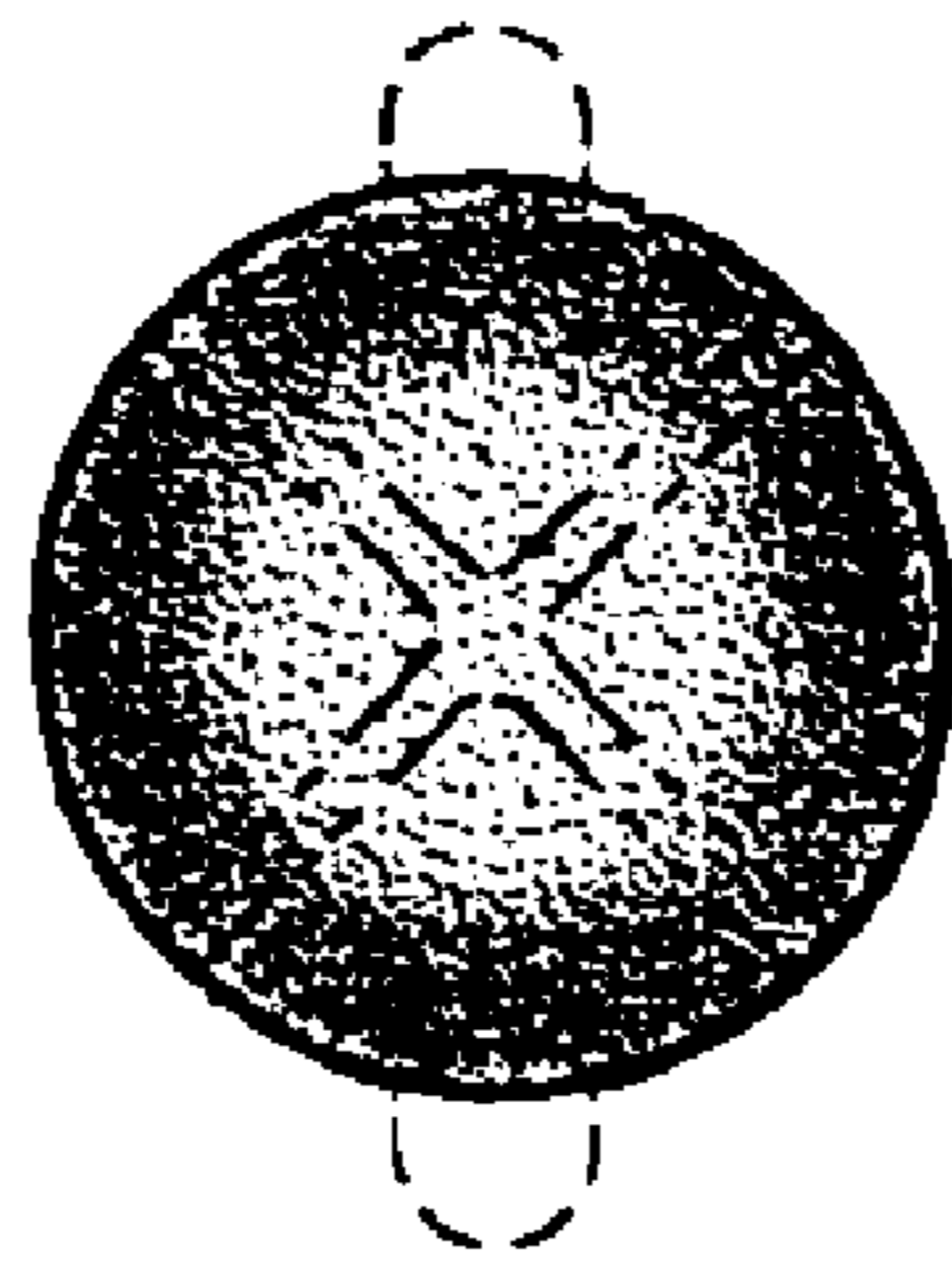

FIG. 5

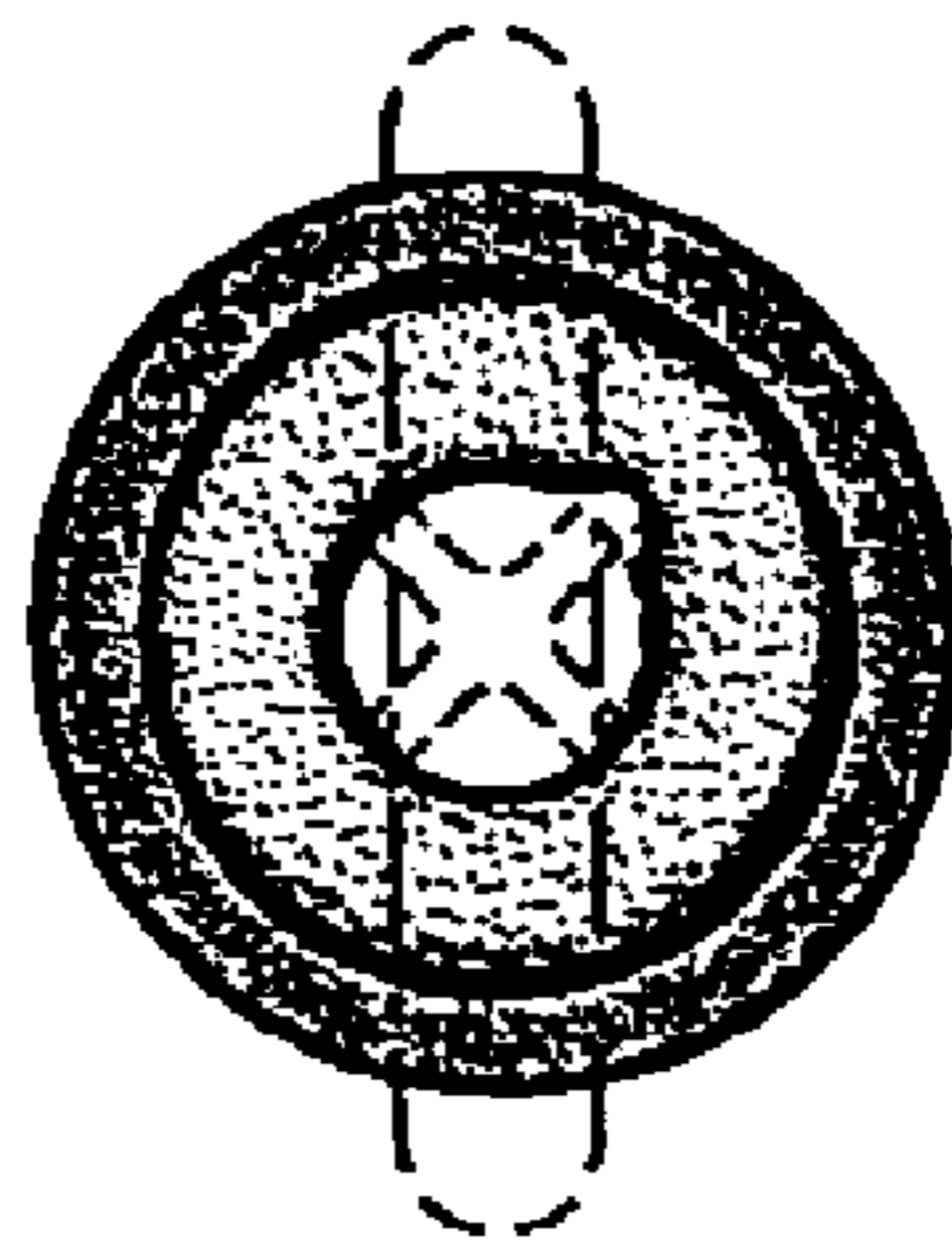

FIG. 6