



US00D511824S

(12) **United States Design Patent**  
**Chen et al.**

(10) **Patent No.:** **US D511,824 S**  
(45) **Date of Patent:** **\*\* Nov. 22, 2005**

(54) **FAN**  
(75) Inventors: **Te-Fu Chen**, Taoyuan (TW); **Tsung-Yu Lei**, Taoyuan (TW); **Kuo-Cheng Lin**, Taoyuan (TW); **Wen-Shi Huang**, Taoyuan (TW)

(73) Assignee: **Delta Electronics, Inc.**, Taoyuan (TW)

(\*\*) Term: **14 Years**

(21) Appl. No.: **29/201,958**

(22) Filed: **Mar. 24, 2004**

(30) **Foreign Application Priority Data**

Jan. 19, 2004 (TW) ..... 93300294

(51) **LOC (8) Cl.** ..... **23-04**

(52) **U.S. Cl.** ..... **D23/370**

(58) **Field of Search** ..... D23/370, 413,  
D23/379; 416/189, 244 R

(56) **References Cited**

**U.S. PATENT DOCUMENTS**

6,238,184 B1 \* 5/2001 Giribaldi ..... 416/189

D446,295 S \* 8/2001 Williams et al. .... D23/370  
6,558,123 B1 \* 5/2003 Spaggiari ..... 416/238

\* cited by examiner

*Primary Examiner*—Lisa Lichtenstein  
(74) *Attorney, Agent, or Firm*—Birch, Stewart, Kolasch & Birch, LLP

(57) **CLAIM**

The ornamental design for a fan, as shown and described.

**DESCRIPTION**

FIG. 1 is a perspective view of fan showing our new design;  
FIG. 2 is a right side view thereof;  
FIG. 3 is a top view thereof;  
FIG. 4 is a front view thereof;  
FIG. 5 is a bottom view thereof;  
FIG. 6 is a left side view thereof; and,  
FIG. 7 is a rear view thereof.

**1 Claim, 5 Drawing Sheets**

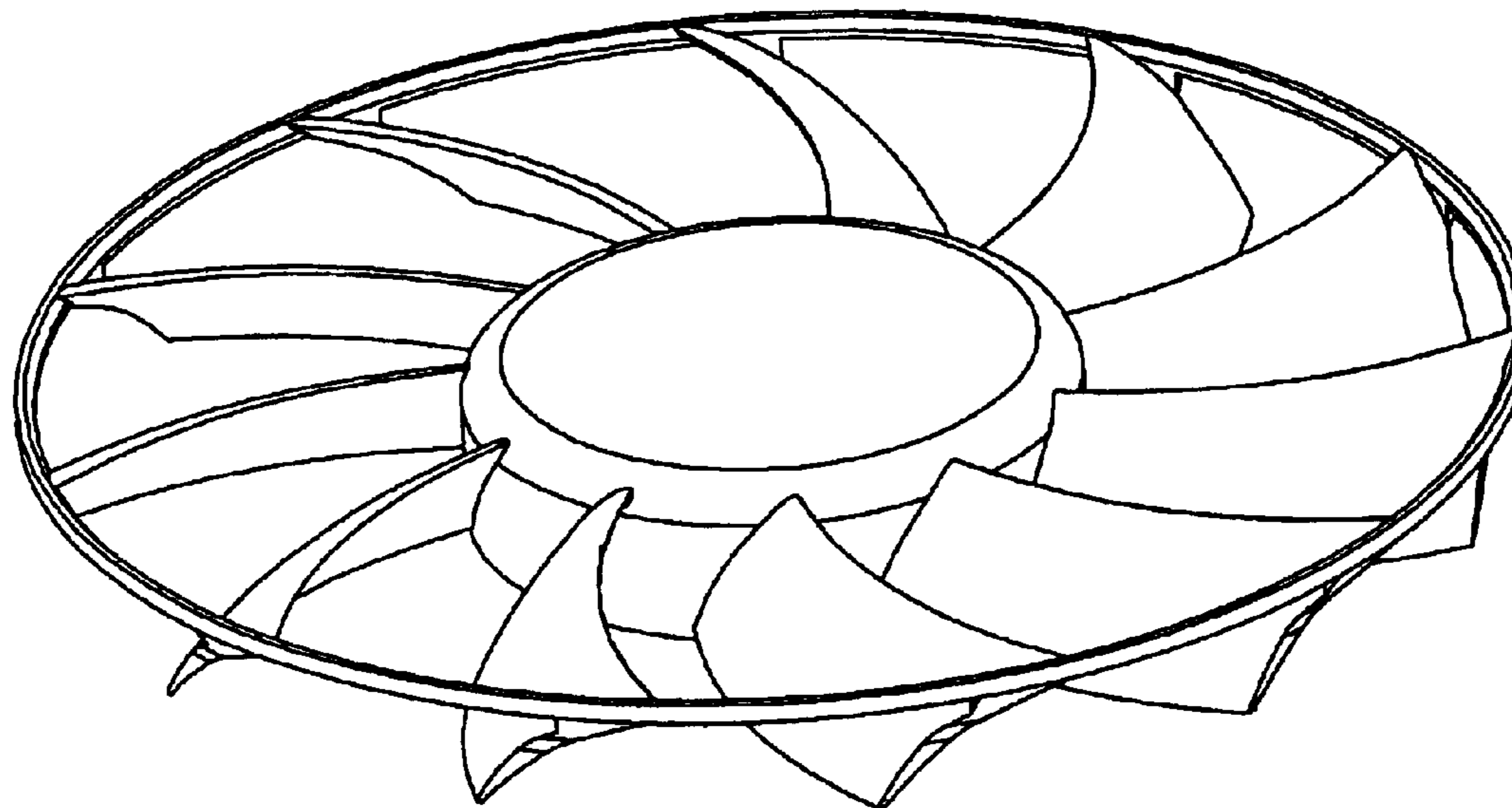

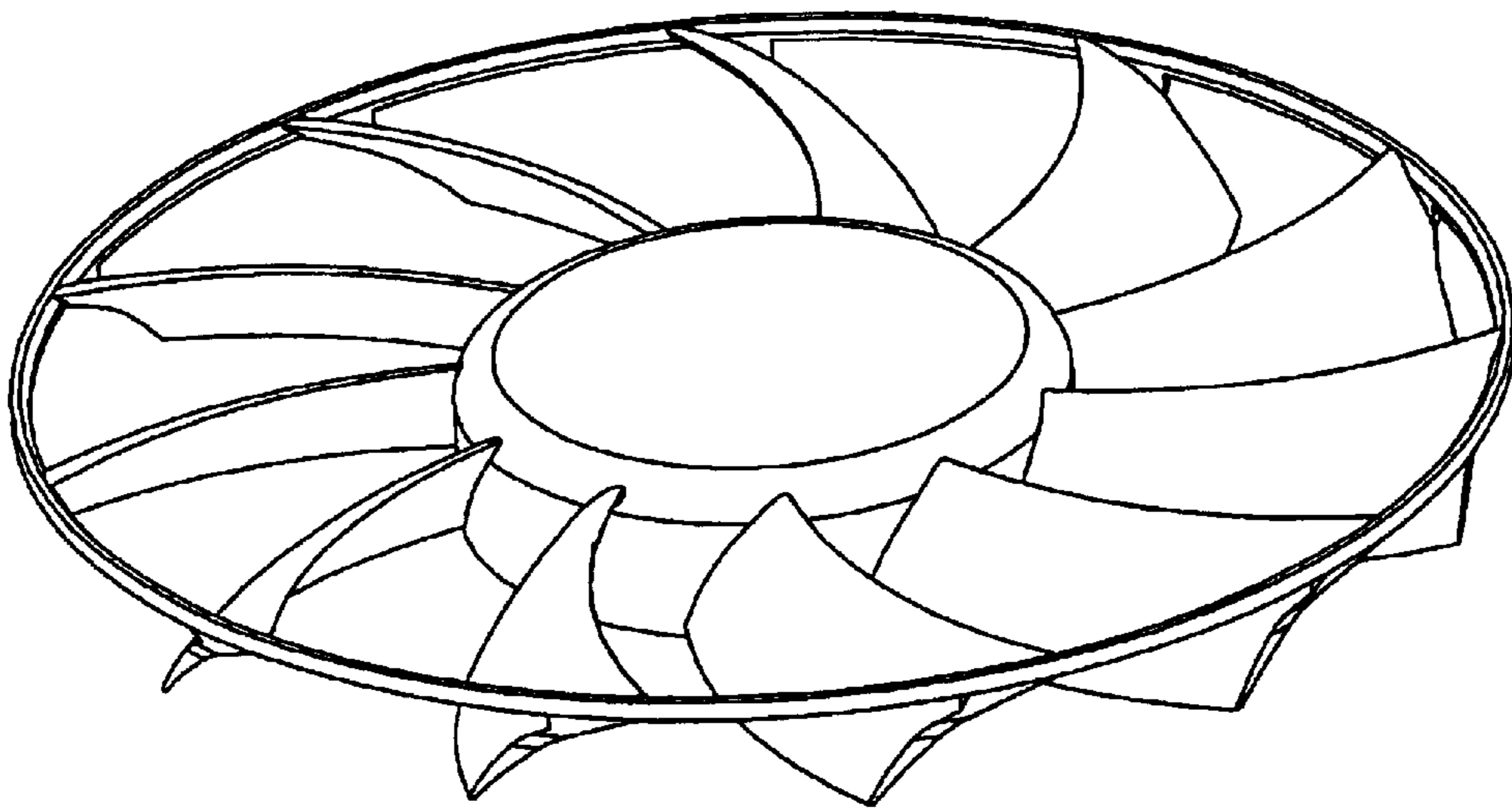

Fig. 1

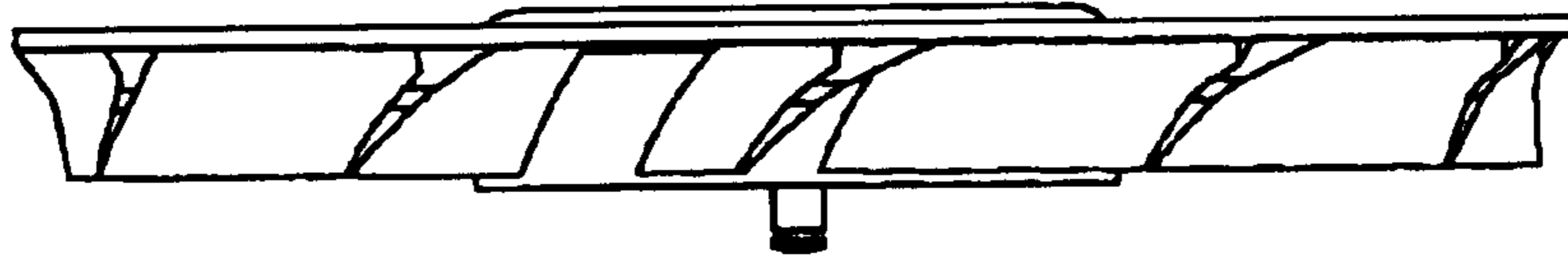

Fig. 2

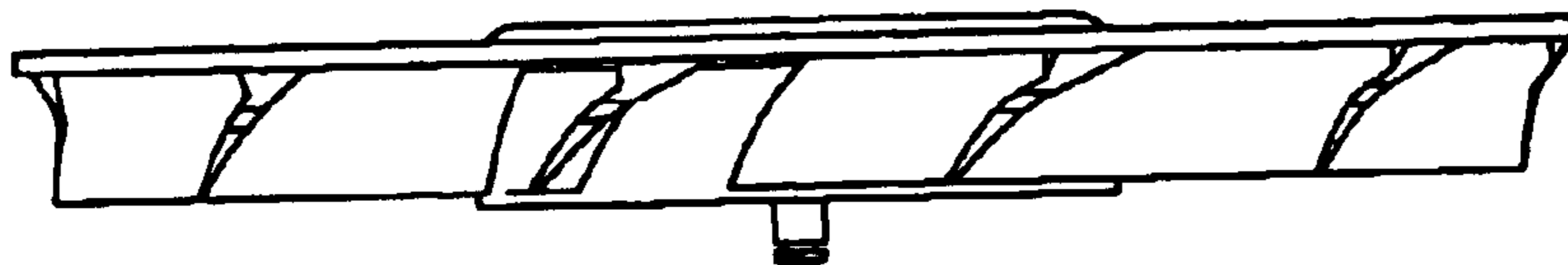

Fig. 6

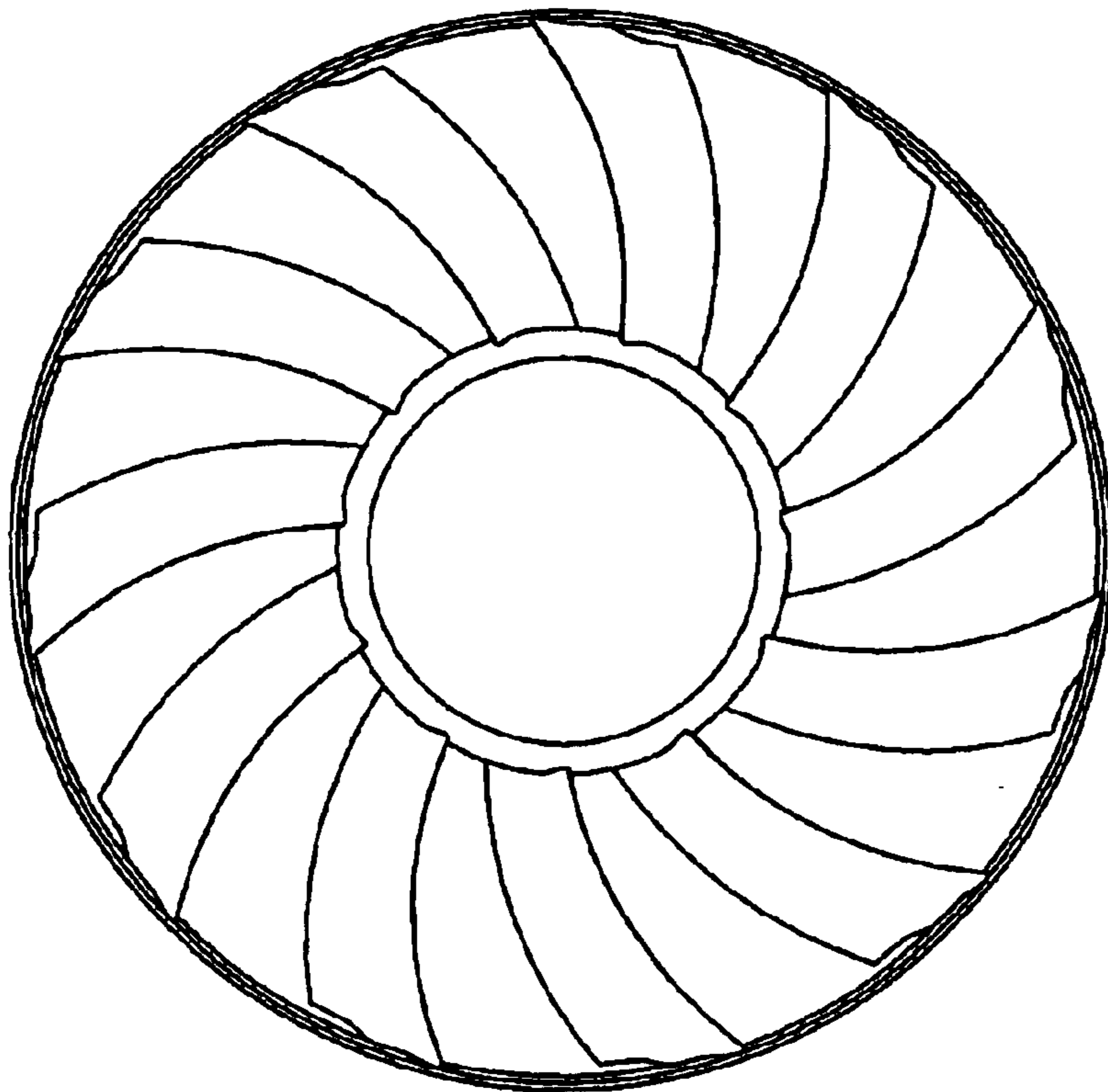

Fig. 3

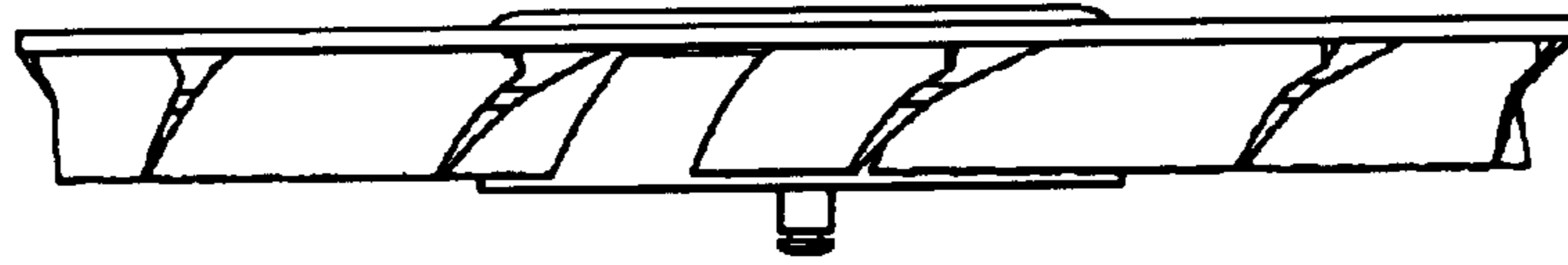

Fig. 4

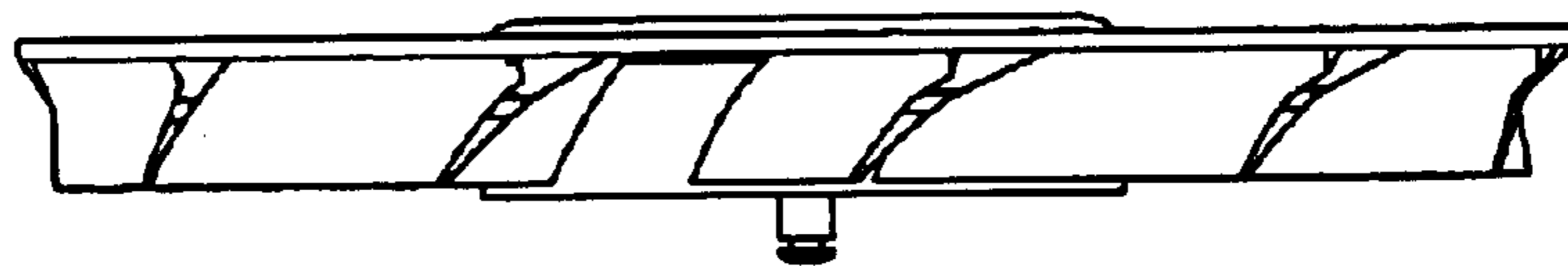

Fig. 7

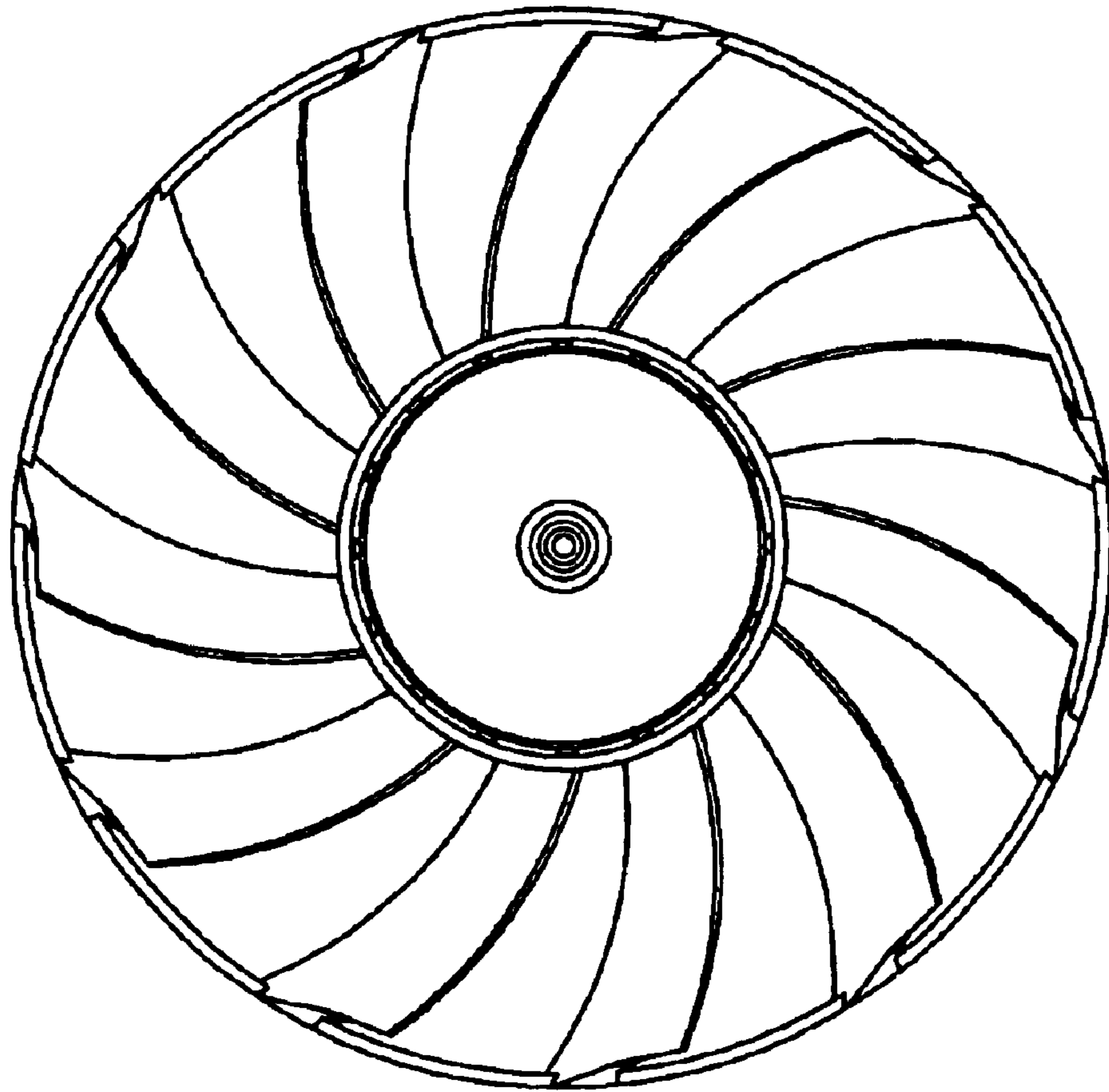

Fig. 5