



US00D511789S

(12) **United States Design Patent**
Canavan et al.

(10) **Patent No.: US D511,789 S**

(45) **Date of Patent: ** Nov. 22, 2005**

(54) **GOGGLE CLIP**

(75) Inventors: **Richard W. Canavan**, Woodstock, CT (US); **Raymond Curci**, Smithfield, RI (US)

(73) Assignee: **Bacou-Dalloz Eye & Face Protection, Inc.**, Smithfield, RI (US)

(**) Term: **14 Years**

(21) Appl. No.: **29/194,918**

(22) Filed: **Dec. 3, 2003**

(51) **LOC (8) Cl.** **16-06**

(52) **U.S. Cl.** **D16/330**

(58) **Field of Search** D16/300-330, D16/339; D29/109-110; D24/110.2; 351/41, 44, 62, 51-52, 155-158; 2/10-13, 15, 426-454

(56) **References Cited**

U.S. PATENT DOCUMENTS

1,554,448 A	9/1925	McKnight et al.	
3,096,553 A	7/1963	Gould	
3,373,444 A	3/1968	Militello	
4,264,987 A	* 5/1981	Runckel	2/445
4,559,678 A	12/1985	Birkenstock	
4,918,753 A	* 4/1990	Mermillod	2/10
4,924,557 A	5/1990	Heckerman et al.	
4,930,163 A	* 6/1990	King	351/158
4,976,531 A	12/1990	Kahaney	
5,002,381 A	3/1991	Murrell	
5,181,280 A	* 1/1993	Zachry, Jr.	2/452

5,410,763 A	5/1995	Bolle	
5,515,551 A	* 5/1996	Yashiro	2/452
5,617,588 A	* 4/1997	Canavan et al.	2/441
5,659,381 A	8/1997	Simioni	
5,706,527 A	1/1998	Kita et al.	
5,711,035 A	* 1/1998	Haslbeck	2/436
5,845,341 A	12/1998	Barthold et al.	
5,937,439 A	* 8/1999	Barthold et al.	2/10
5,940,891 A	* 8/1999	Lane	2/426
6,105,177 A	* 8/2000	Paulson et al.	2/431
6,149,268 A	11/2000	Hall et al.	
6,276,794 B1	8/2001	Chiang	
6,276,795 B1	* 8/2001	Hall et al.	351/62
6,349,420 B1	2/2002	Chiang	
6,477,717 B1	11/2002	Wineforder et al.	

* cited by examiner

Primary Examiner—Raphael Barkai

(74) *Attorney, Agent, or Firm*—Salter & Michaelson

(57) **CLAIM**

The ornamental design for a goggle clip, as shown.

DESCRIPTION

FIG. 1 is a perspective view of a goggle clip, showing our new design;
FIG. 2 is a front elevational view thereof;
FIG. 3 is a rear elevational view thereof;
FIG. 4 is a left side elevational view thereof;
FIG. 5 is a right side elevational view thereof;
FIG. 6 is a top plan view thereof; and,
FIG. 7 is a bottom plan view thereof.

1 Claim, 2 Drawing Sheets

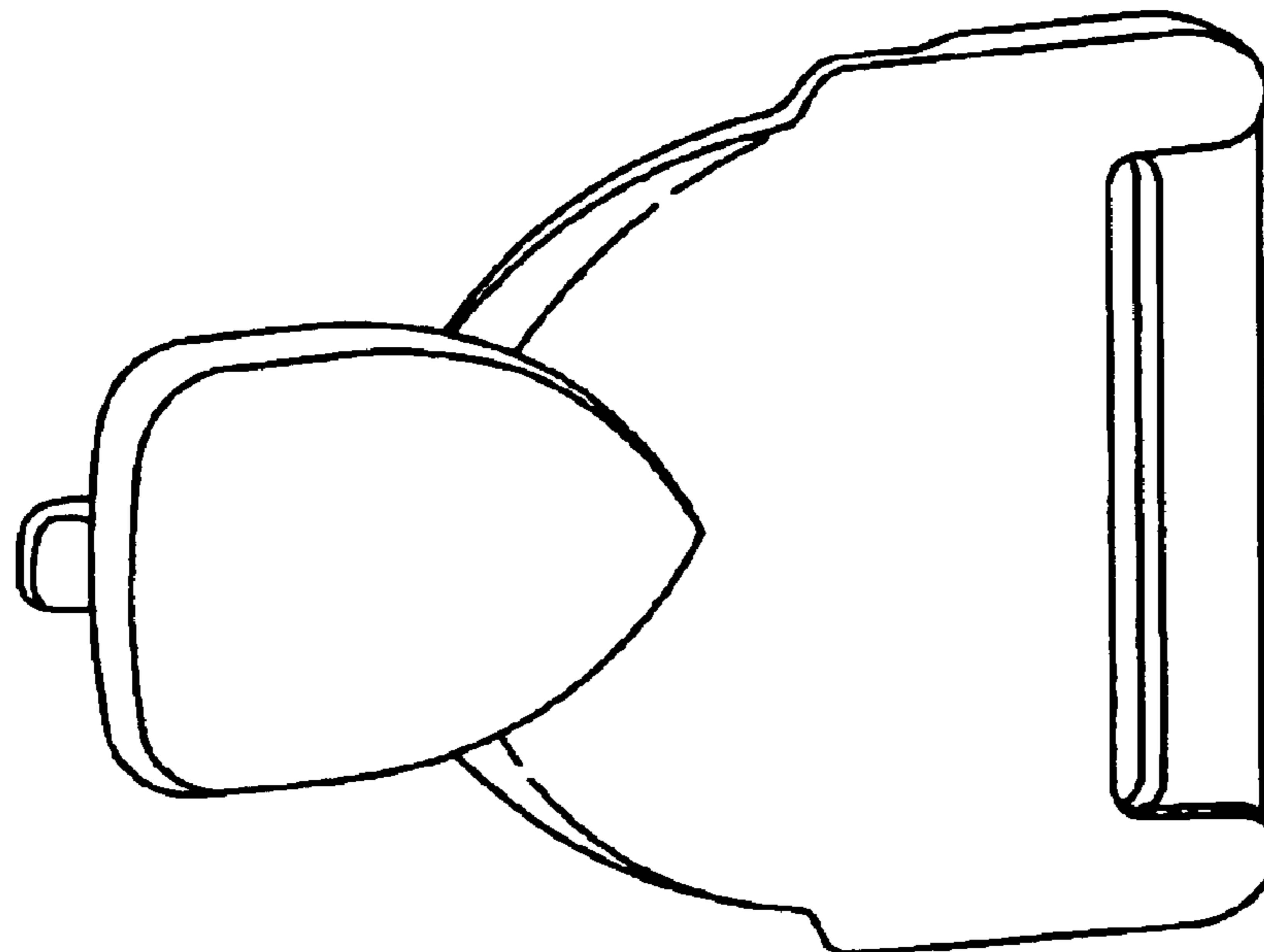

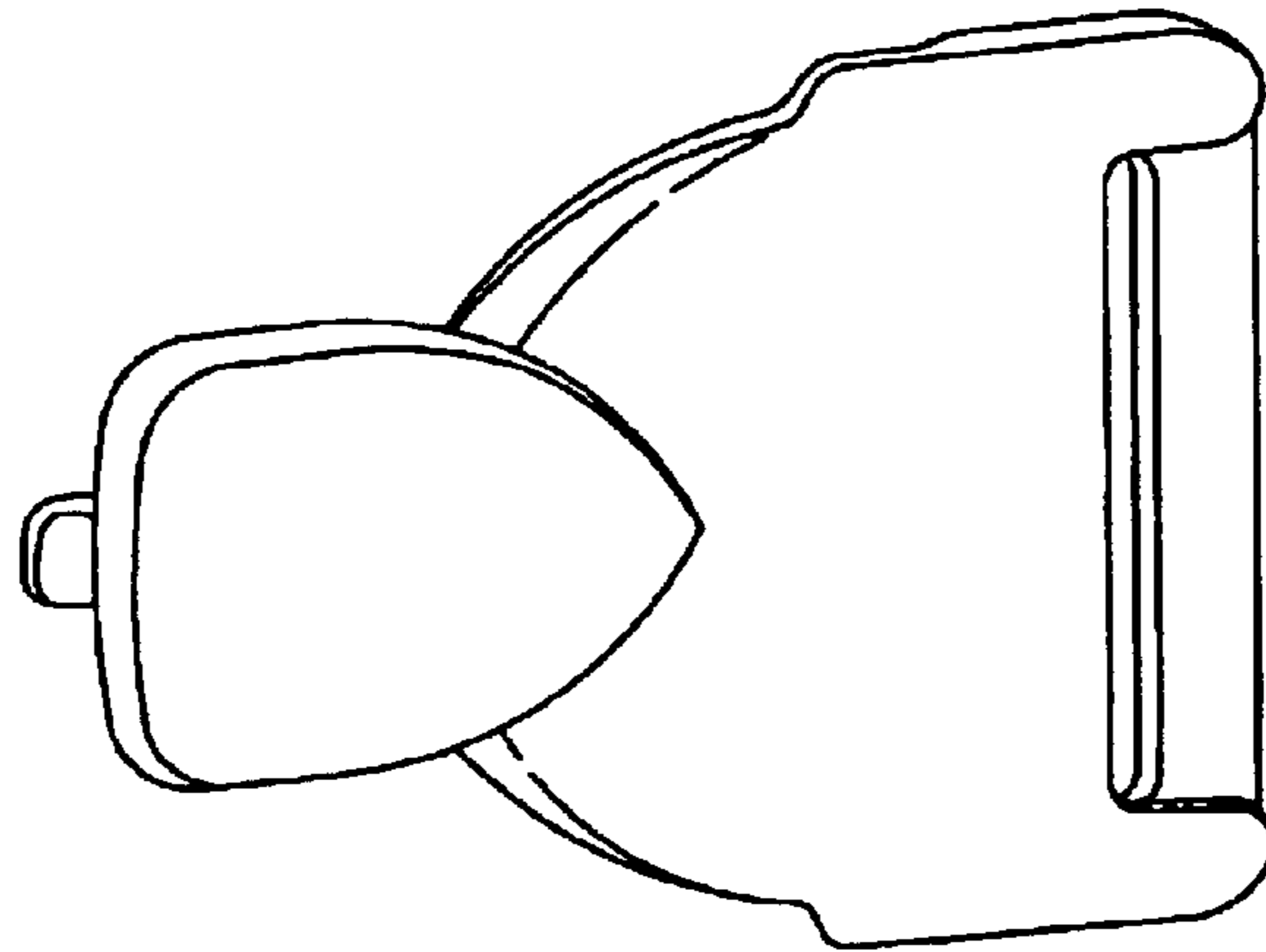

FIG. 1

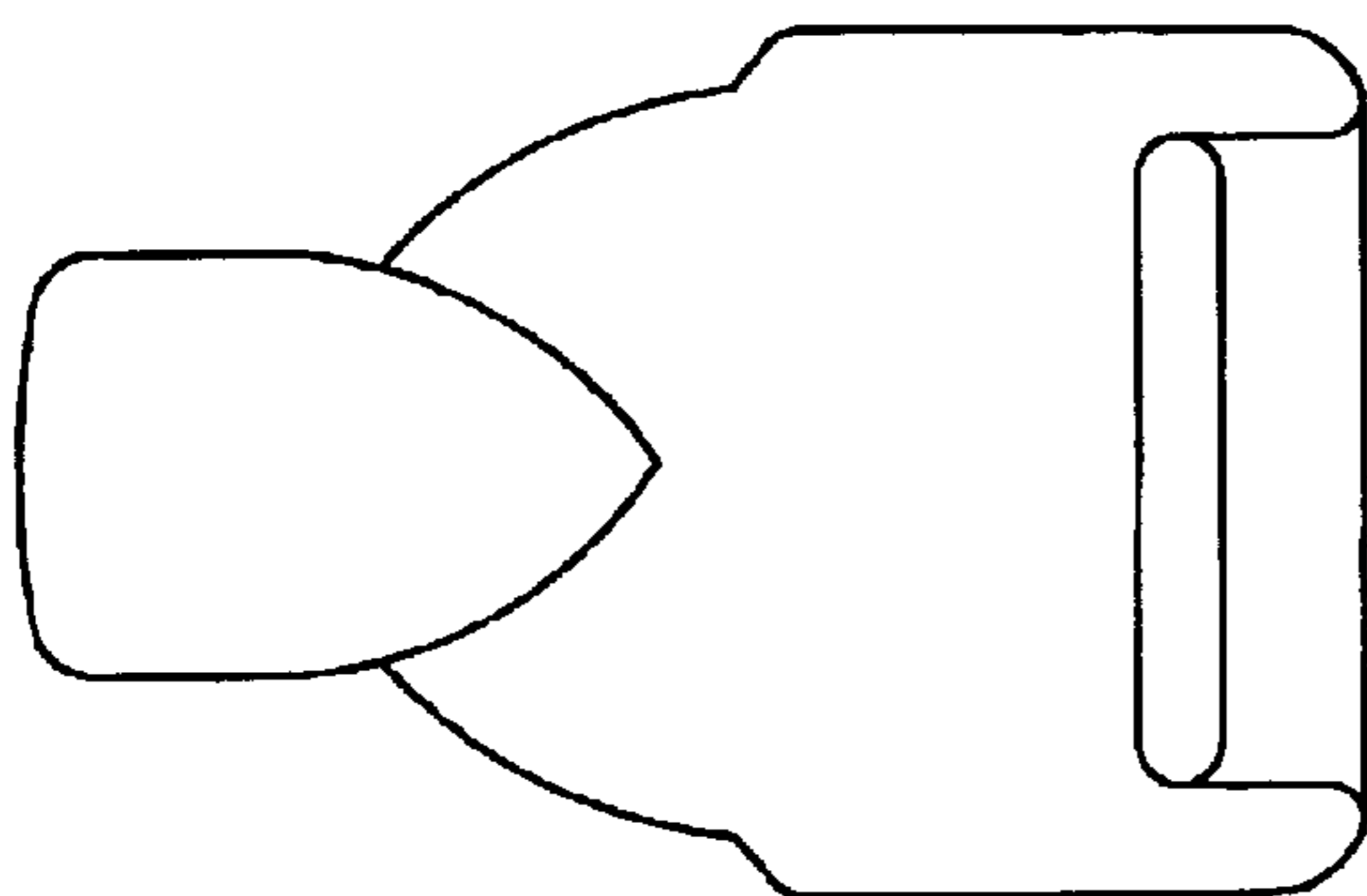

FIG. 2

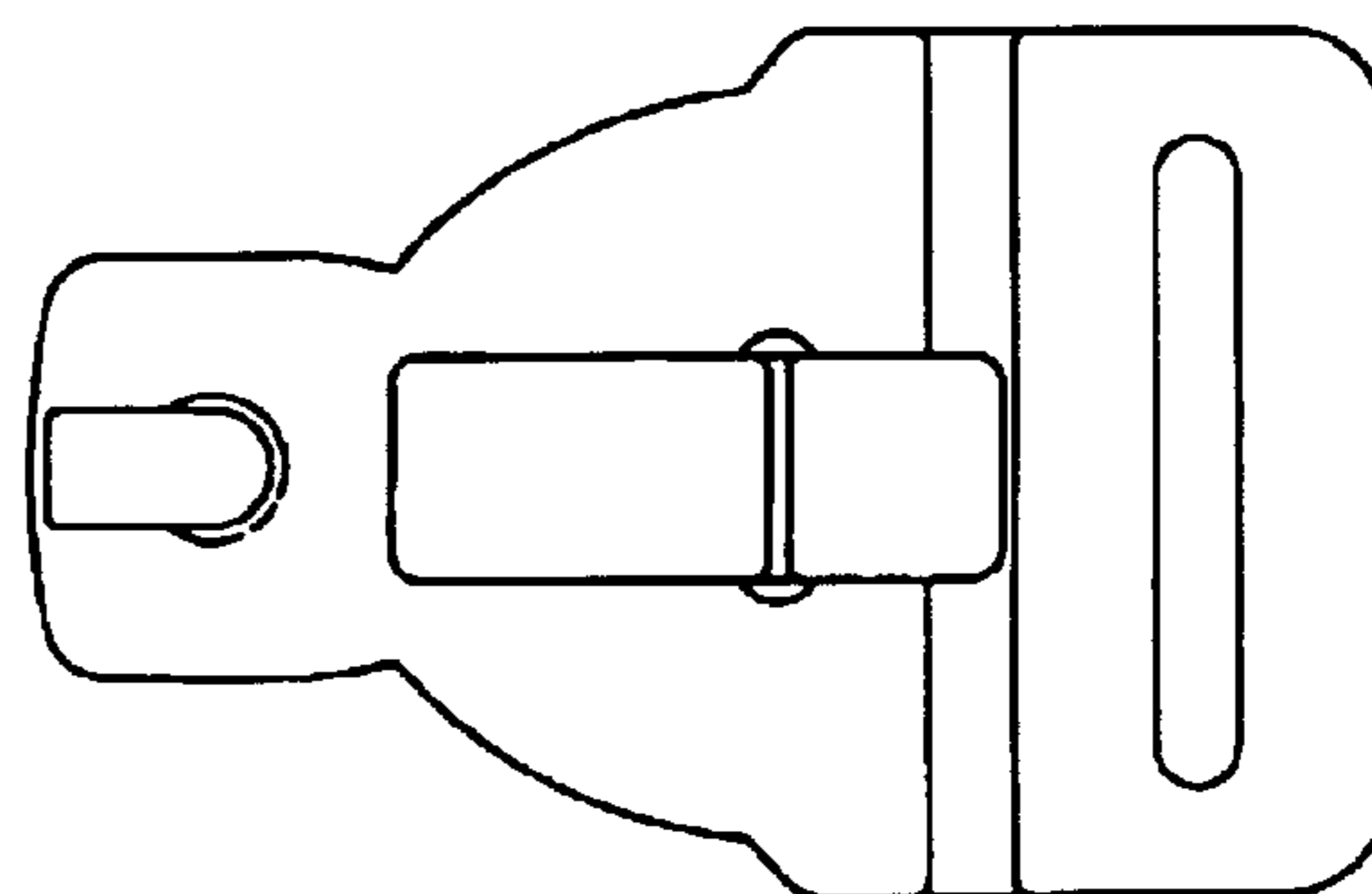

FIG. 3

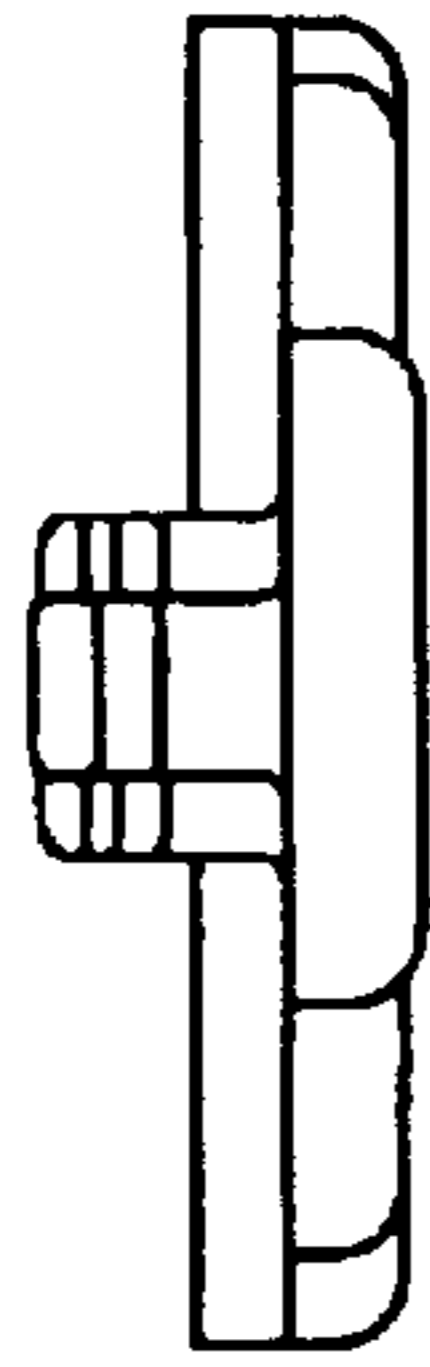

FIG. 4



FIG. 5

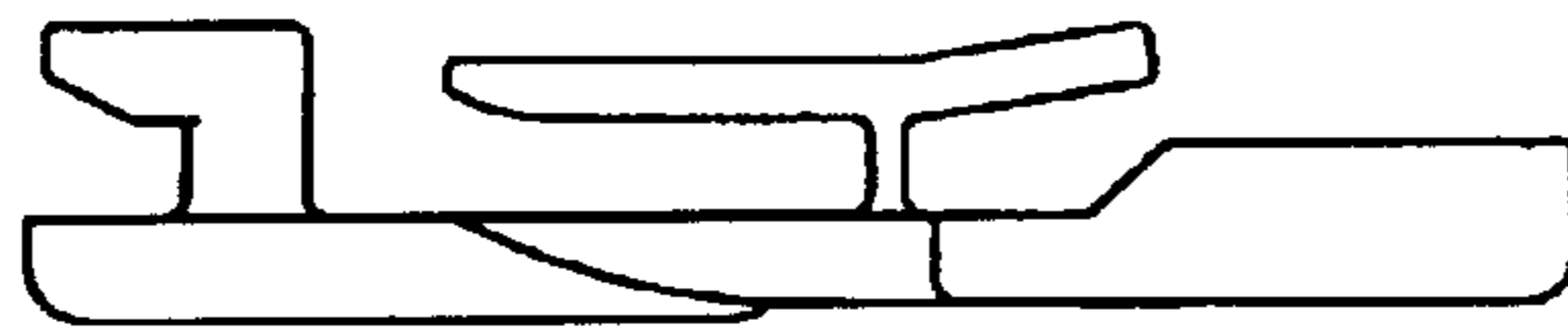

FIG. 6

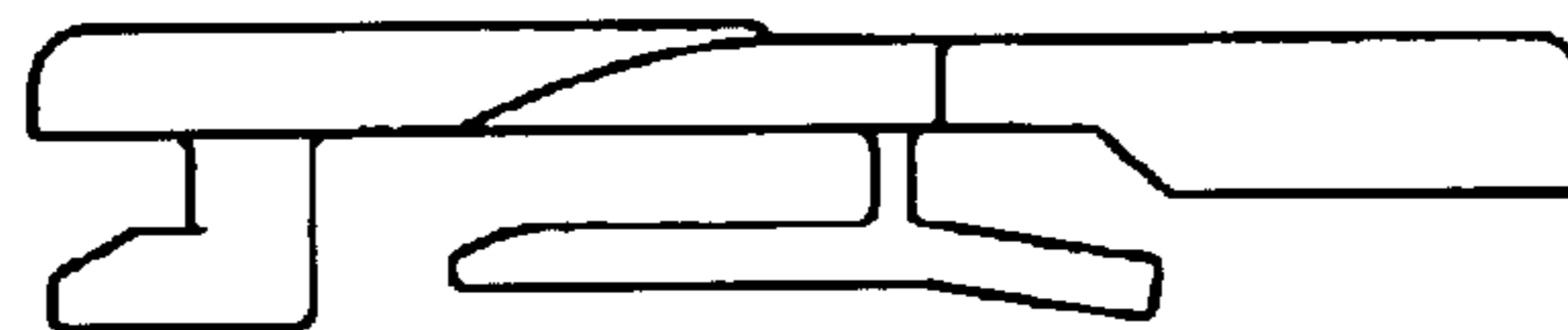

FIG. 7