



US00D511737S

(12) **United States Design Patent**
Tuech

(10) **Patent No.:** **US D511,737 S**

(45) **Date of Patent:** **** Nov. 22, 2005**

(54) **SADDLEBAG FOR A MOTORCYCLE**

4,869,408 A 9/1989 Lutz
4,966,260 A 10/1990 Young
5,031,807 A 7/1991 Tiffany
D366,447 S * 1/1996 Berman D12/409

(76) **Inventor:** **Ronald D. Tuech**, 703 Rambling Rd.,
Johnson City, TN (US) 37604

(**) **Term:** **14 Years**

* cited by examiner

(21) **Appl. No.:** **29/207,174**

Primary Examiner—Alan P. Douglas

Assistant Examiner—Linda Brooks

(22) **Filed:** **Jun. 9, 2004**

(74) *Attorney, Agent, or Firm*—Gable and Gotwals;
Michael E. Sellers

(51) **LOC (8) Cl.** **12-16**

(52) **U.S. Cl.** **D12/409**

(57) **CLAIM**

(58) **Field of Search** D12/110, 114,
D12/409, 410; 224/412–433, 435, 924,
436–439, 42.11, 42.31

I claim the ornamental design for a saddle bag for a motorcycle, as shown and described.

DESCRIPTION

(56) **References Cited**

FIG. 1 is a right side view of a saddle bag for a motorcycle showing my design, the dotted lines showing a section of a motorcycle is for illustrative purposes only and forms no part of the claimed design;

U.S. PATENT DOCUMENTS

D22,057 S	12/1892	Gilhuly
1,963,333 A	6/1934	Morales
D152,530 S	2/1949	Hampel
2,491,062 A	12/1949	Shephard
D163,701 S	6/1951	Rochelle
D247,524 S	3/1978	Graham
4,258,869 A	3/1981	Hilgendorff
4,402,439 A	9/1983	Brown
D272,428 S	1/1984	Kelley
4,442,960 A	4/1984	Vetter
4,450,988 A	5/1984	Meisel
4,821,853 A	4/1989	Young

FIG. 2 is a top, right side perspective view thereof;

FIG. 3 is a right side view of the saddle bag without the dotted lines of FIG. 1;

FIG. 4 is a left side view thereof;

FIG. 5 is a top view thereof;

FIG. 6 is a front view thereof;

FIG. 7 is a back view thereof; and,

FIG. 8 is a bottom view thereof.

1 Claim, 4 Drawing Sheets

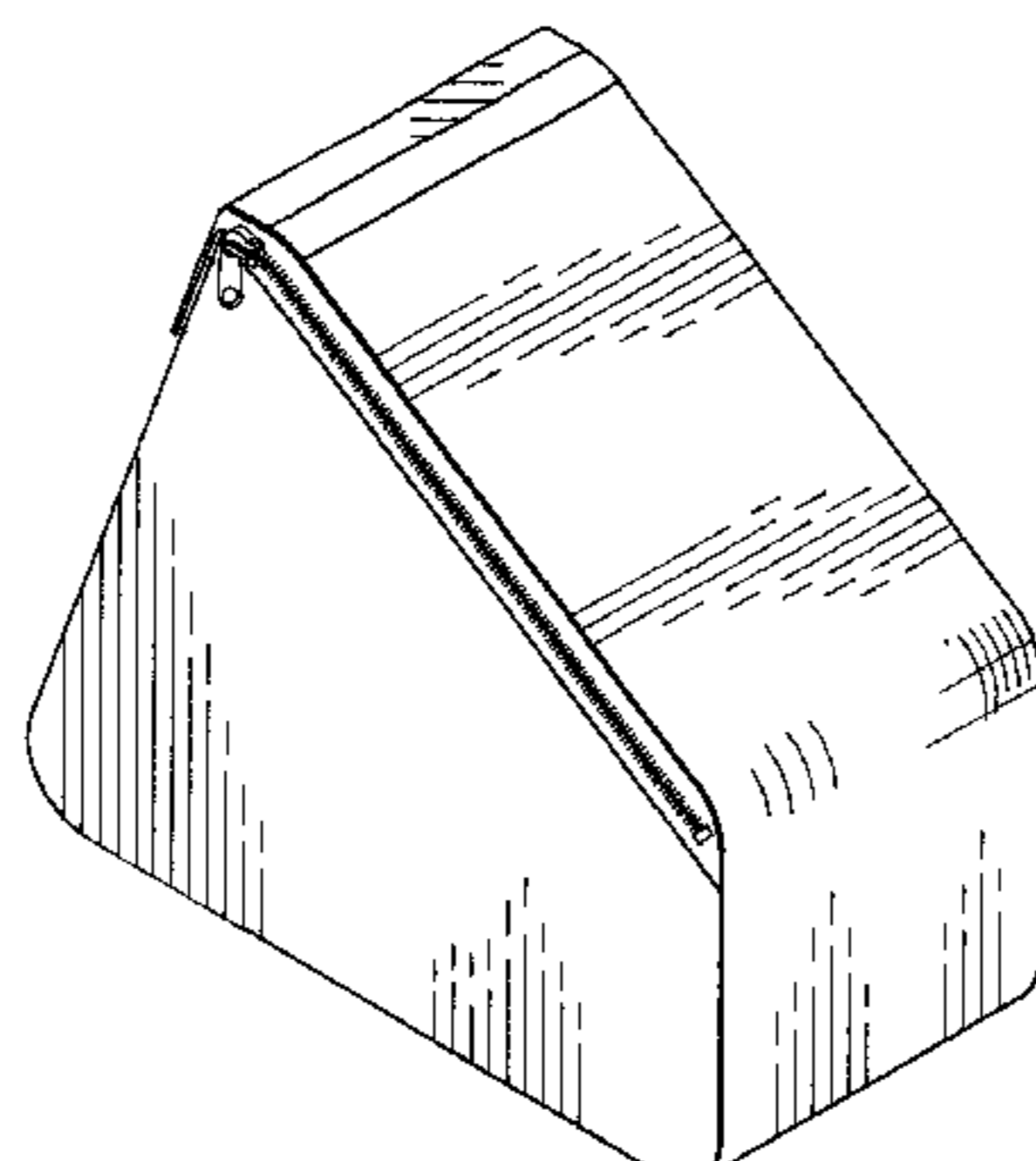
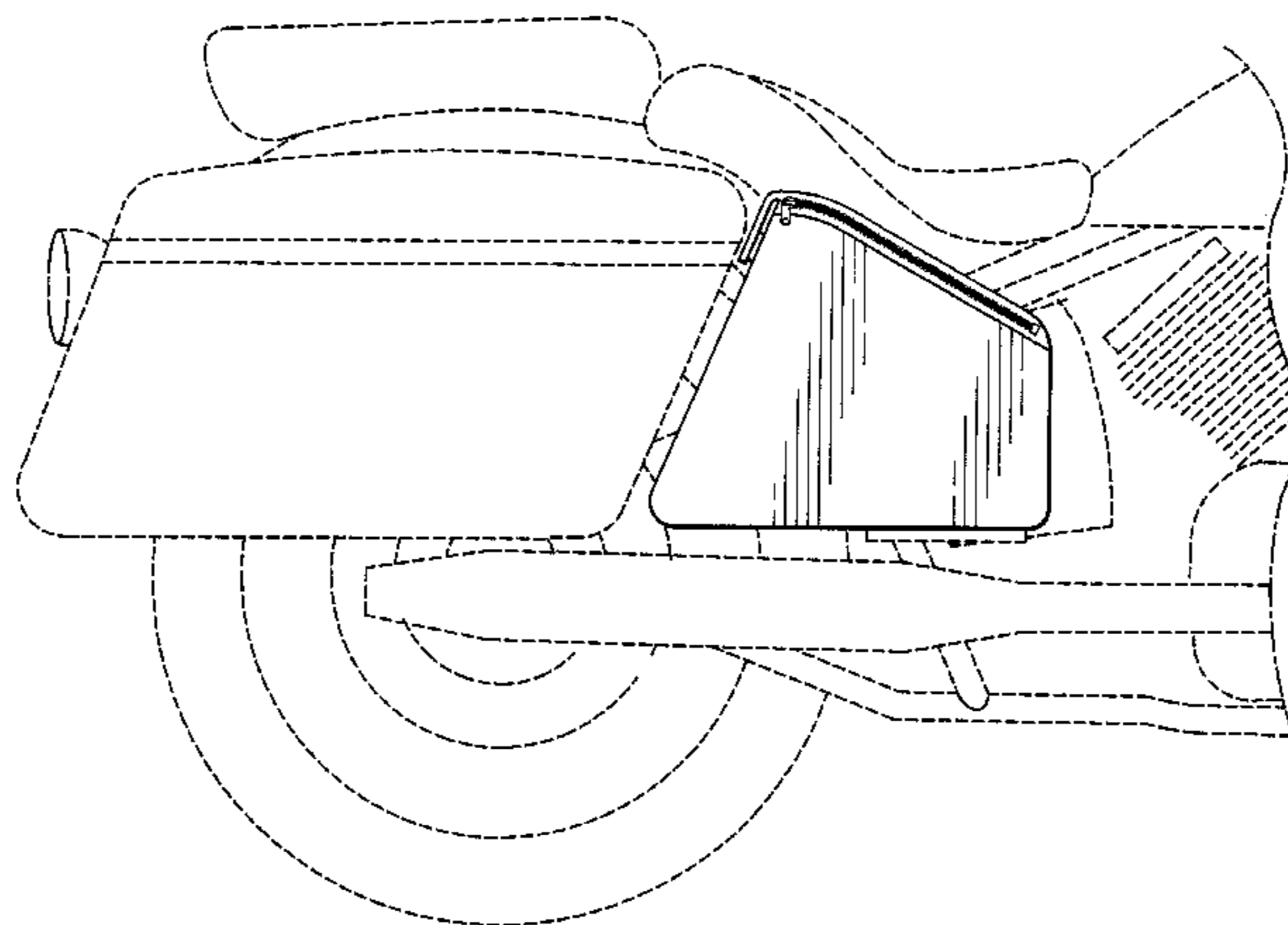

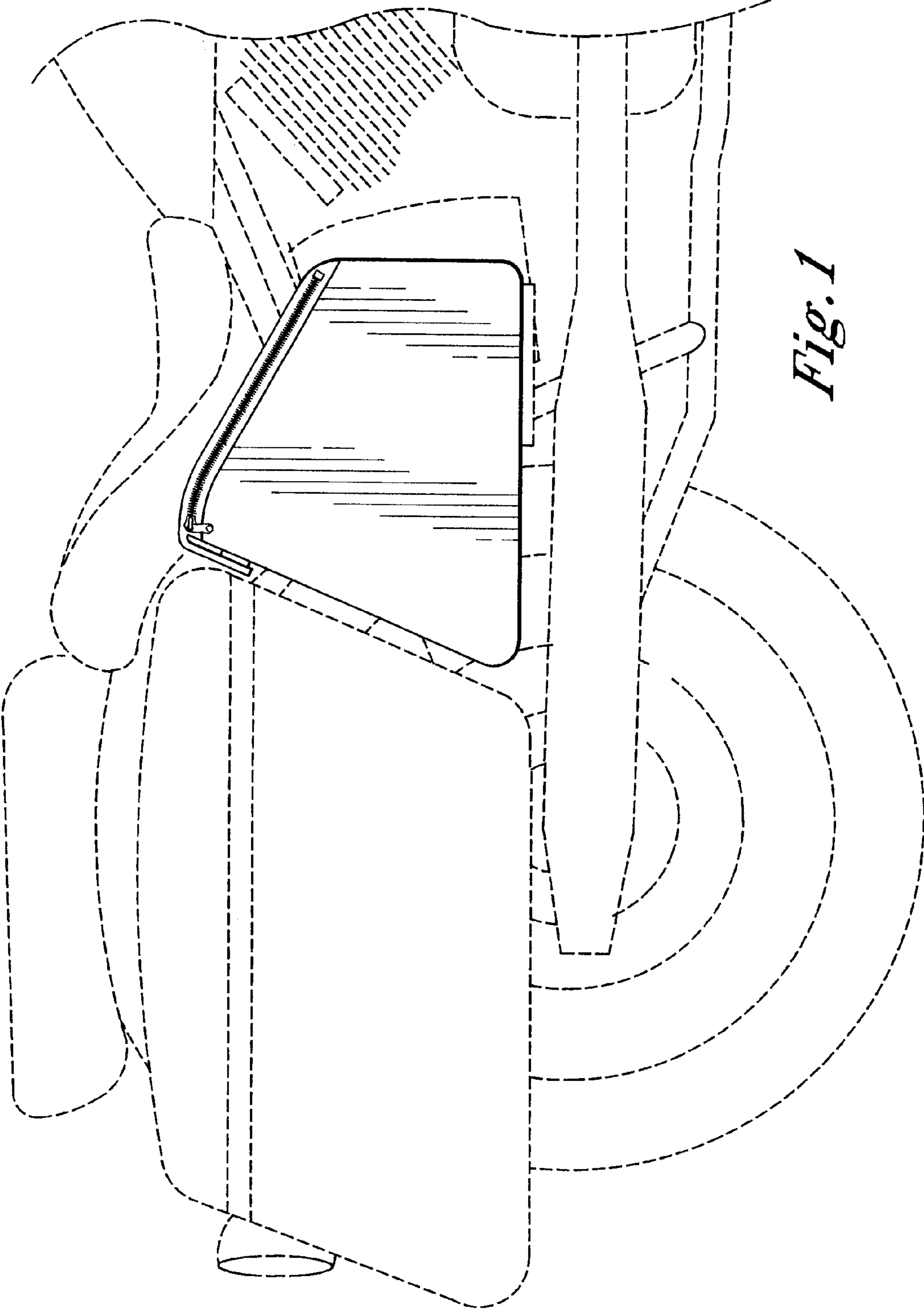

Fig. 1

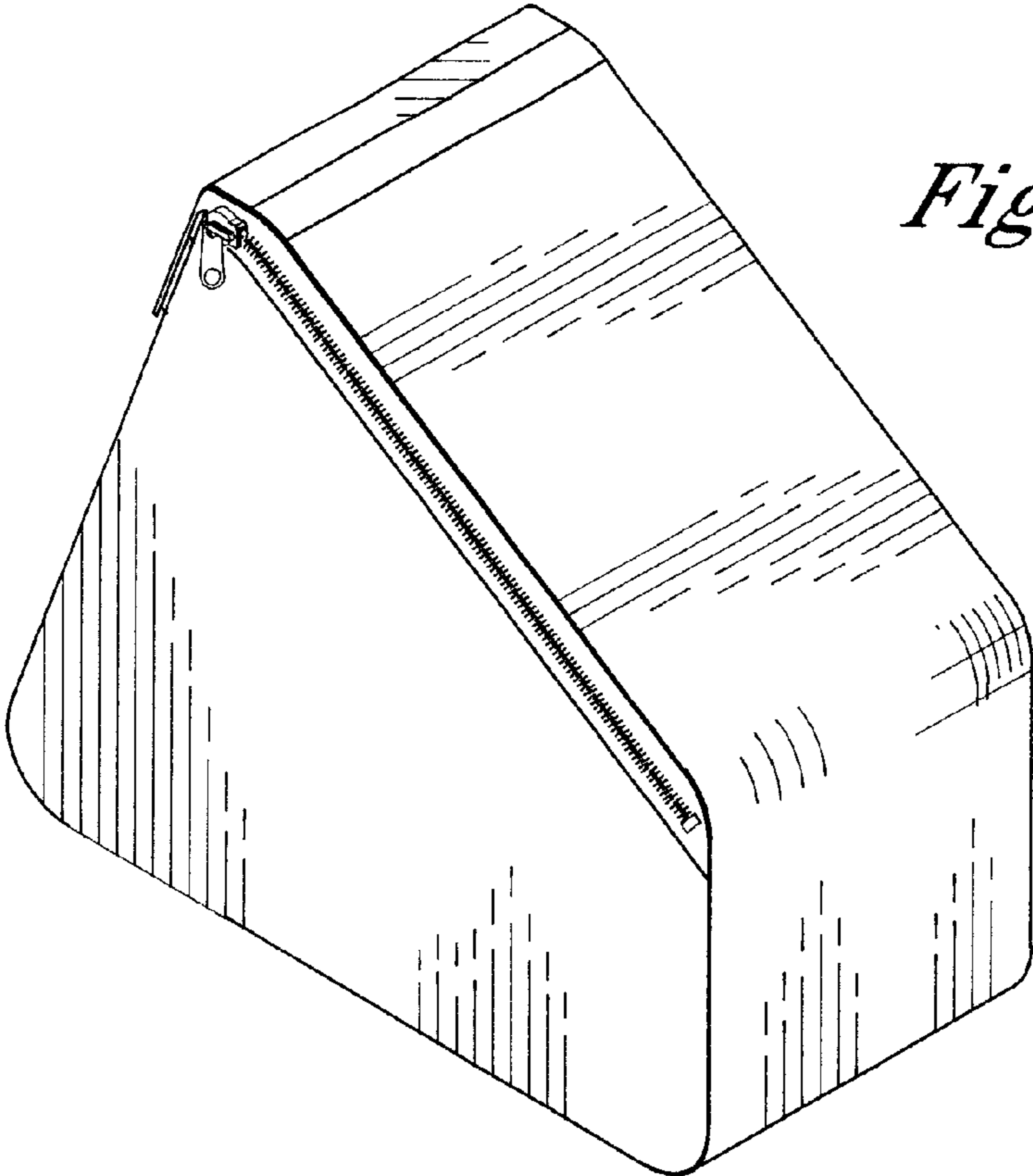

Fig. 2

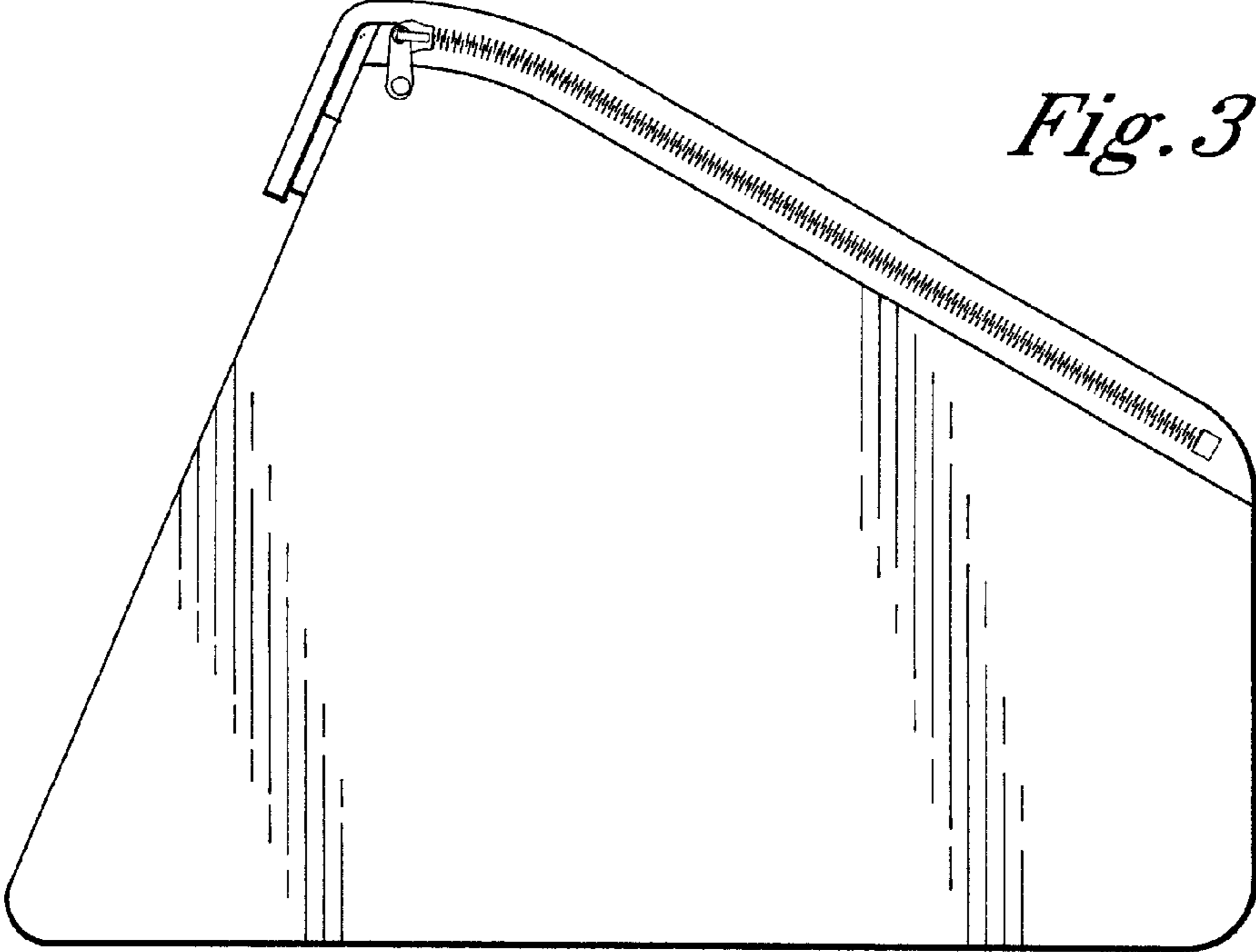

Fig. 3

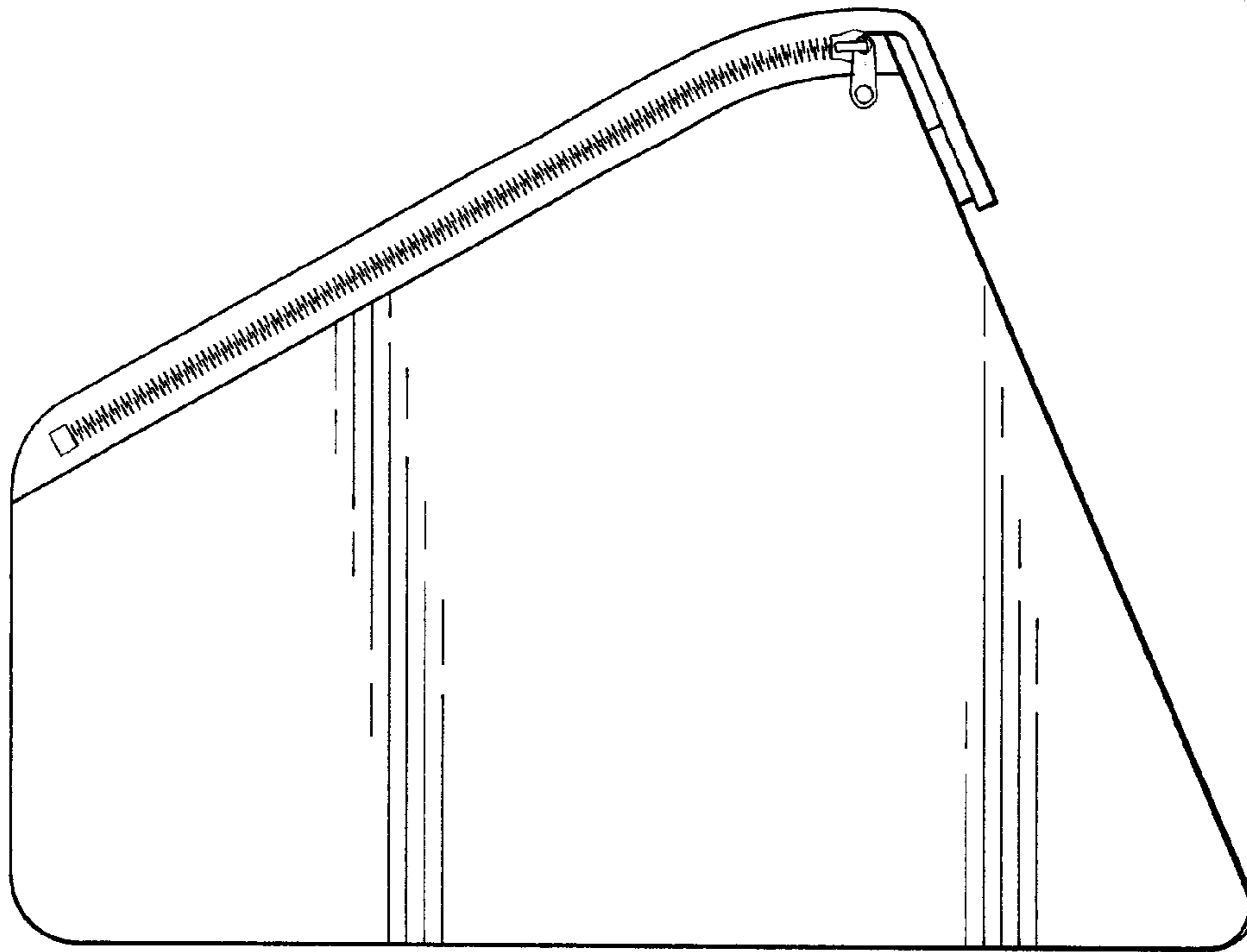

Fig. 4

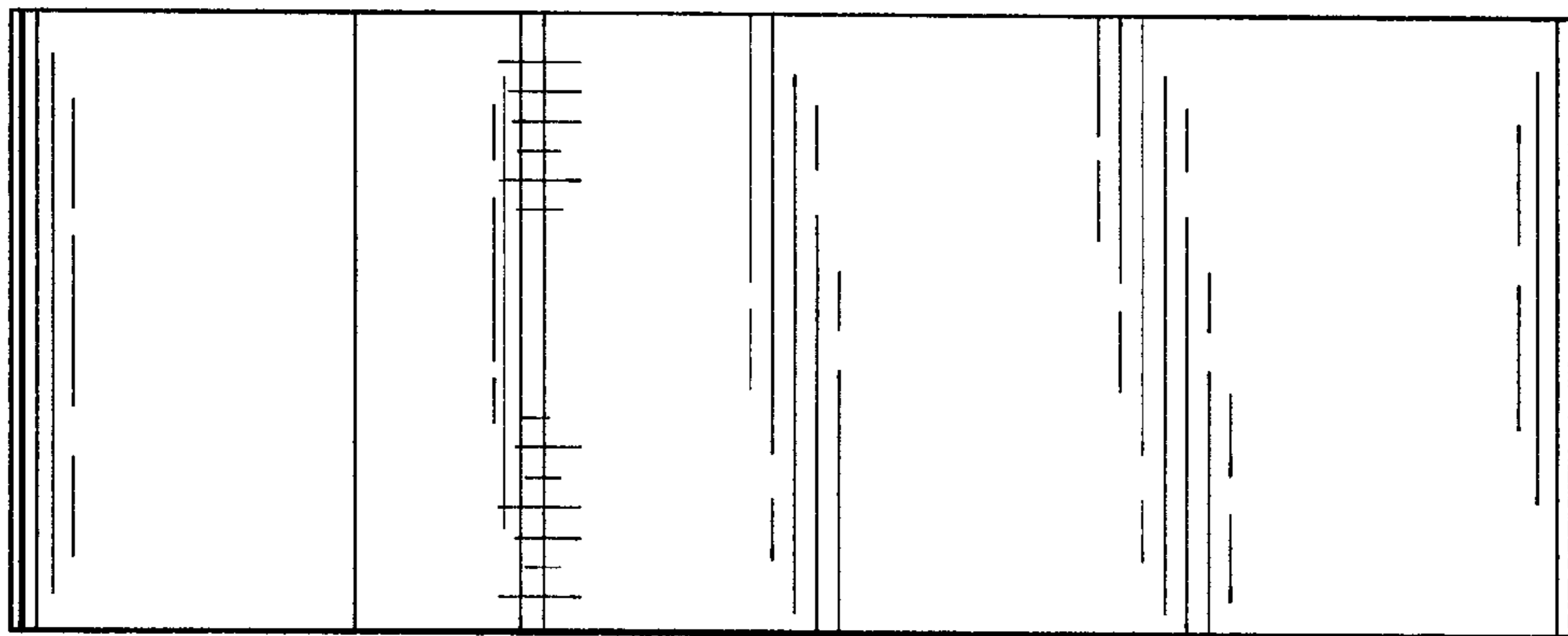

Fig. 5

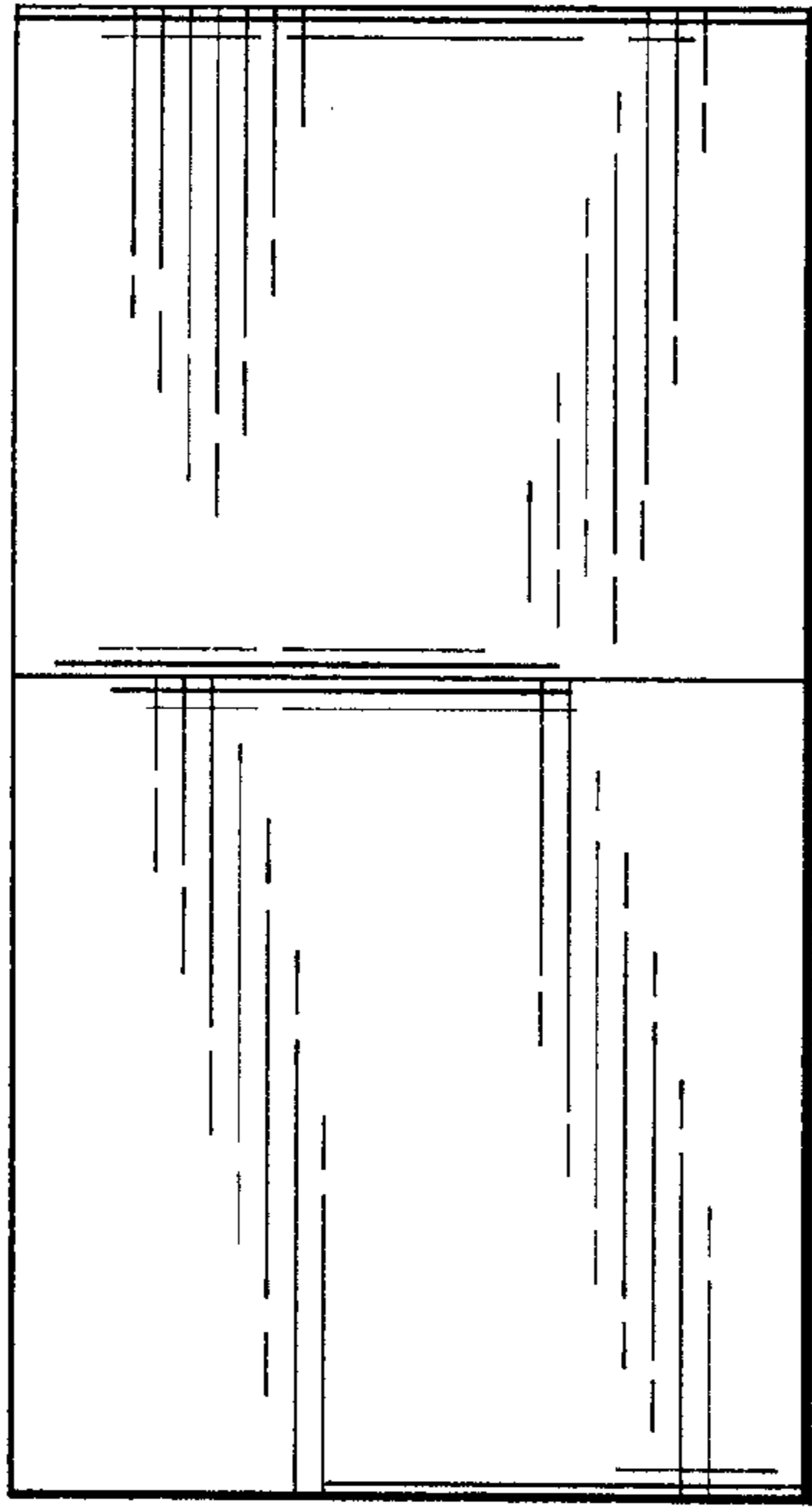

Fig. 6

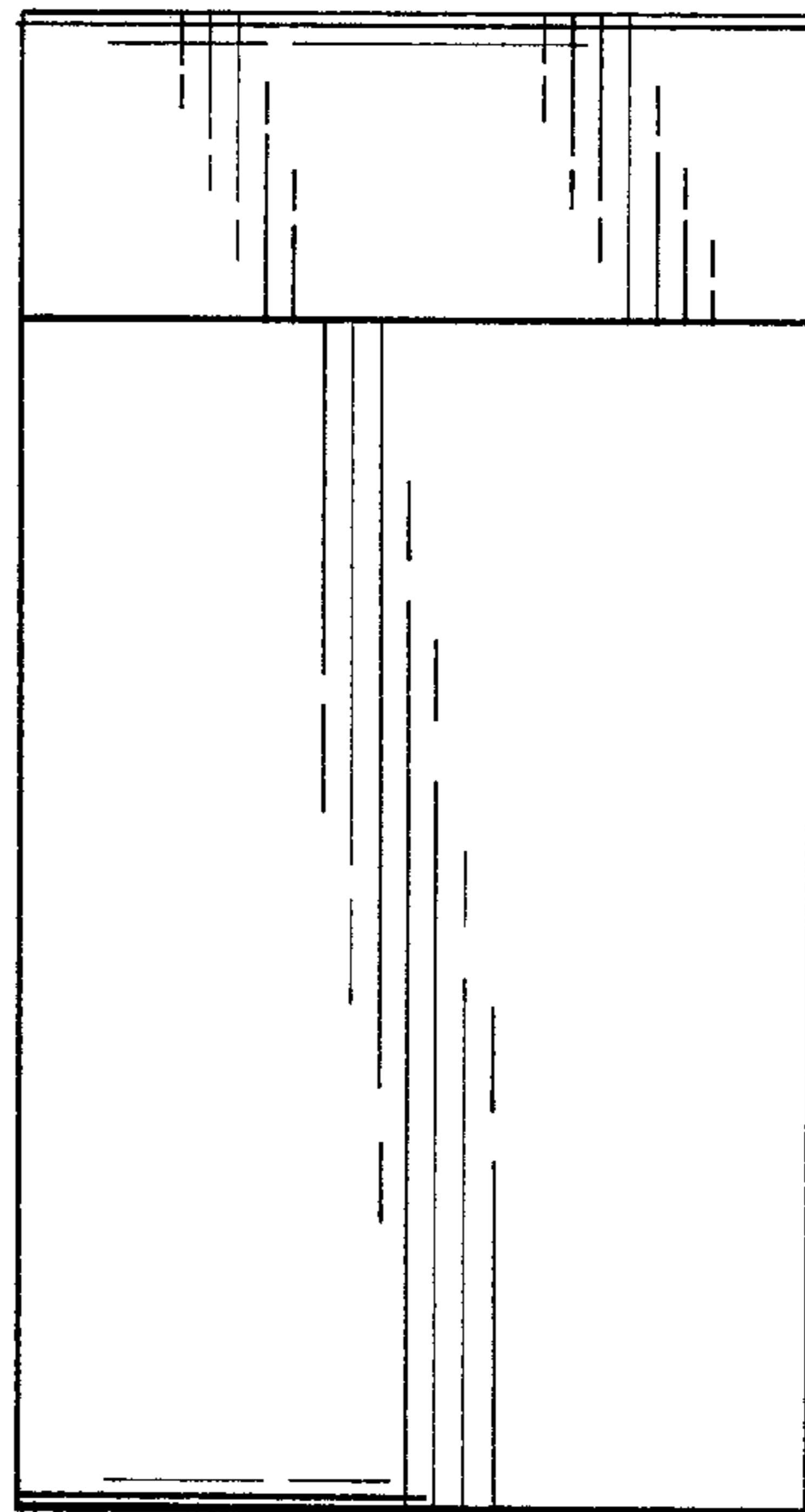

Fig. 7

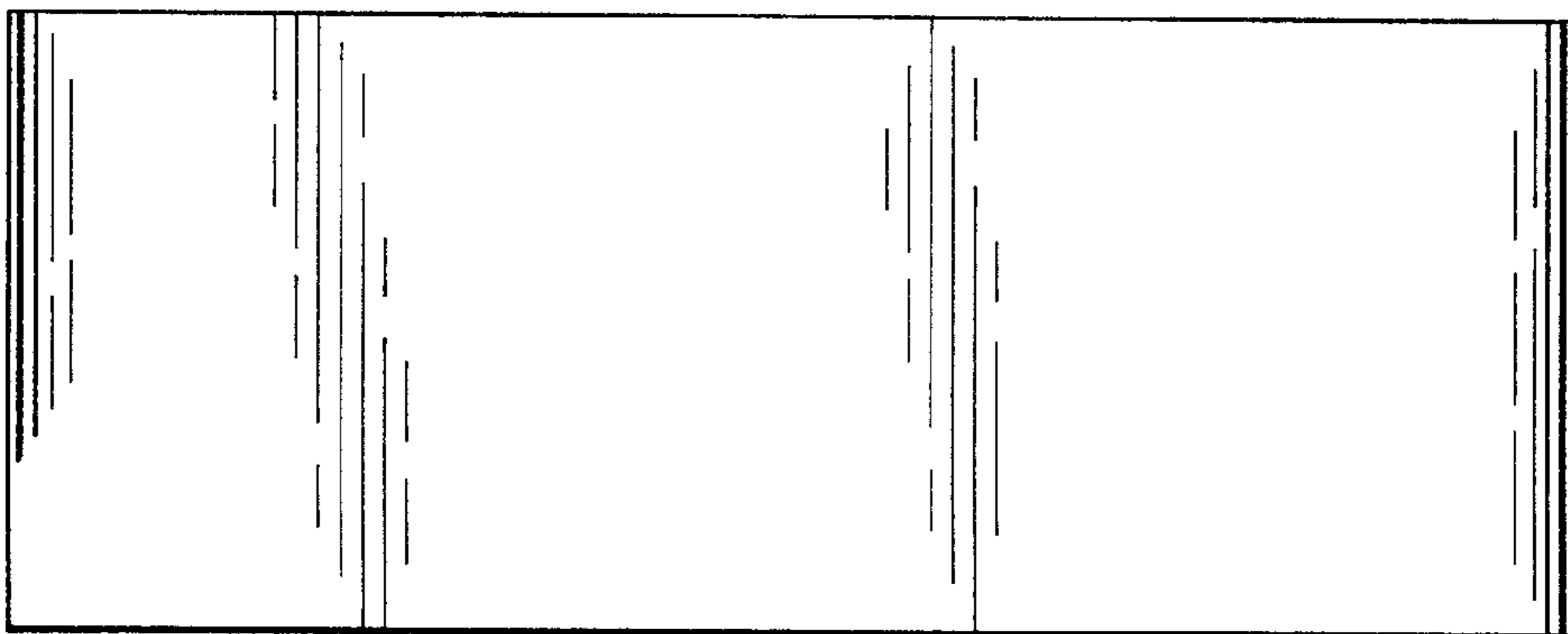

Fig. 8