



US00D511604S

(12) **United States Design Patent**
Moritz et al.

(10) **Patent No.: US D511,604 S**

(45) **Date of Patent: ** Nov. 15, 2005**

(54) **CREMATION URN WITH MOTORCYCLE
GAS TANK SHAPE**

D493,410 S * 7/2004 Krejci D12/218
D498,199 S * 11/2004 Sugimoto et al. D12/218

(76) Inventors: **James G. Moritz**, 4216 S. 91st Pl.,
Greenfield, WI (US) 53228; **Ronald D.
Winkler**, 10 Lockhaven Ct., Henderson,
NV (US) 89074

* cited by examiner

Primary Examiner—Paula A. Greene
(74) *Attorney, Agent, or Firm*—Andrus, Scales, Starke &
Sawall, LLP

(**) Term: **14 Years**

(57) **CLAIM**

(21) Appl. No.: **29/215,906**

The ornamental design for a cremation urn with motorcycle
gas tank shape, as shown and described.

(22) Filed: **Oct. 26, 2004**

DESCRIPTION

(51) **LOC (8) Cl.** **99-00**

(52) **U.S. Cl.** **D99/5**

(58) **Field of Search** D99/1, 3, 5, 29,
D99/30; 27/1-10, 19, 27, 35; D12/218;
248/214; 280/833; 180/219; 220/475

FIG. 1 is a perspective view of a cremation urn with
motorcycle gas tank shape showing our new ornamental
design;

FIG. 2 is a top view of the cremation urn with motorcycle
gas tank shape shown in FIG. 1;

FIG. 3 is a front view of the cremation urn with motorcycle
gas tank shape shown in FIG. 2;

FIG. 4 is a view of the cremation urn with motorcycle gas
tank shape taken from the right side of FIG. 2;

FIG. 5 is a view of the cremation urn with motorcycle gas
tank shape taken from the left side of FIG. 2;

FIG. 6 is a rear view of the cremation urn with motorcycle
gas tank shape shown in FIG. 3; and,

FIG. 7 is a bottom view of the cremation urn with motor-
cycle gas tank shape shown in FIG. 3.

(56) **References Cited**

U.S. PATENT DOCUMENTS

D163,837 S * 7/1951 Waldron D99/3
3,741,429 A * 6/1973 Purcell et al. 220/475
4,469,190 A * 9/1984 Yamaguchi 180/219
5,542,706 A * 8/1996 Kubly 280/833
D432,486 S * 10/2000 Krejci D12/218
6,370,744 B1 * 4/2002 Mendez 27/2
D482,998 S * 12/2003 Krejci D12/218
D484,668 S * 12/2003 Morgan et al. D99/29
6,691,962 B1 * 2/2004 Krejci 248/214
D493,409 S * 7/2004 Krejci D12/218

1 Claim, 2 Drawing Sheets

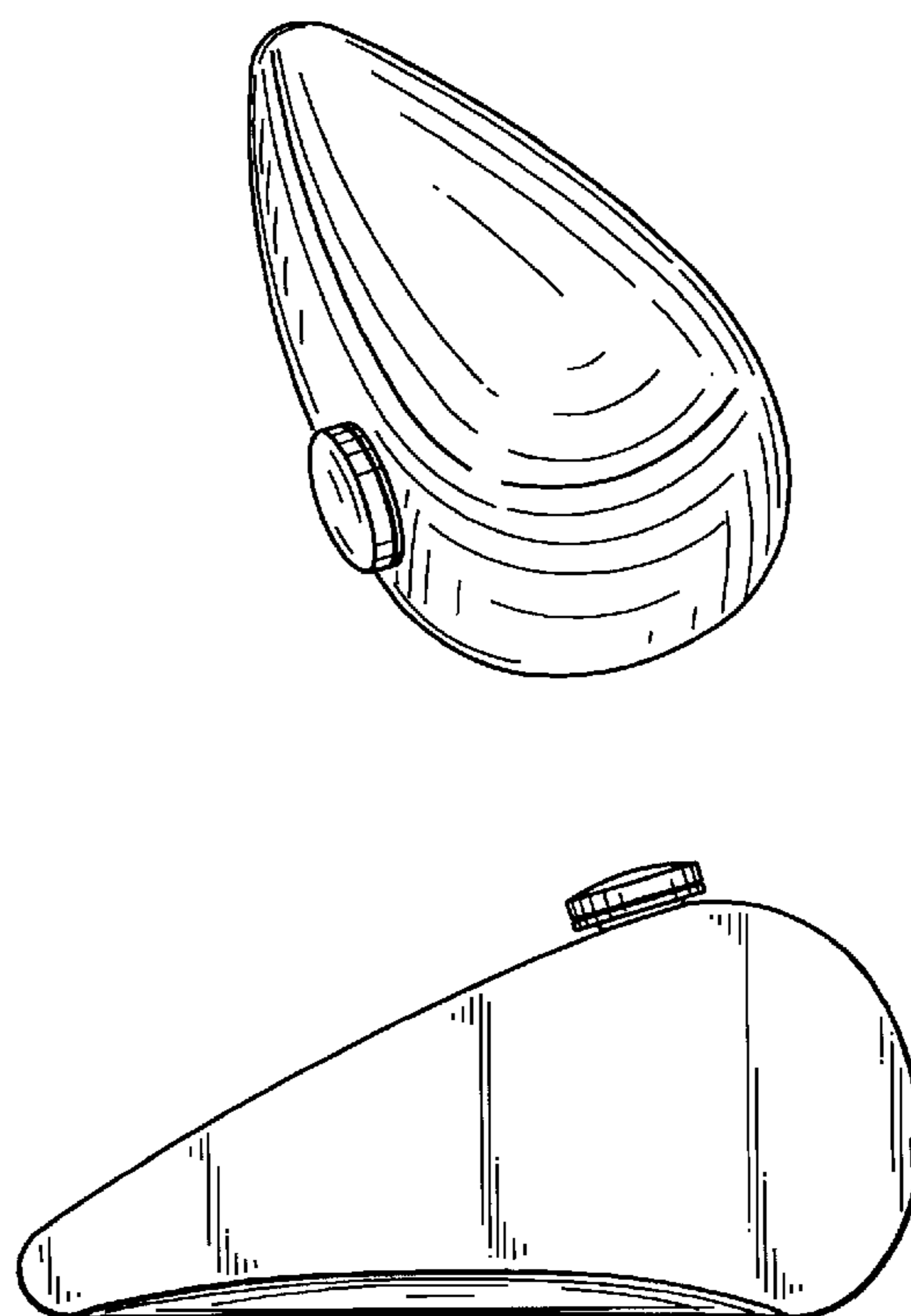

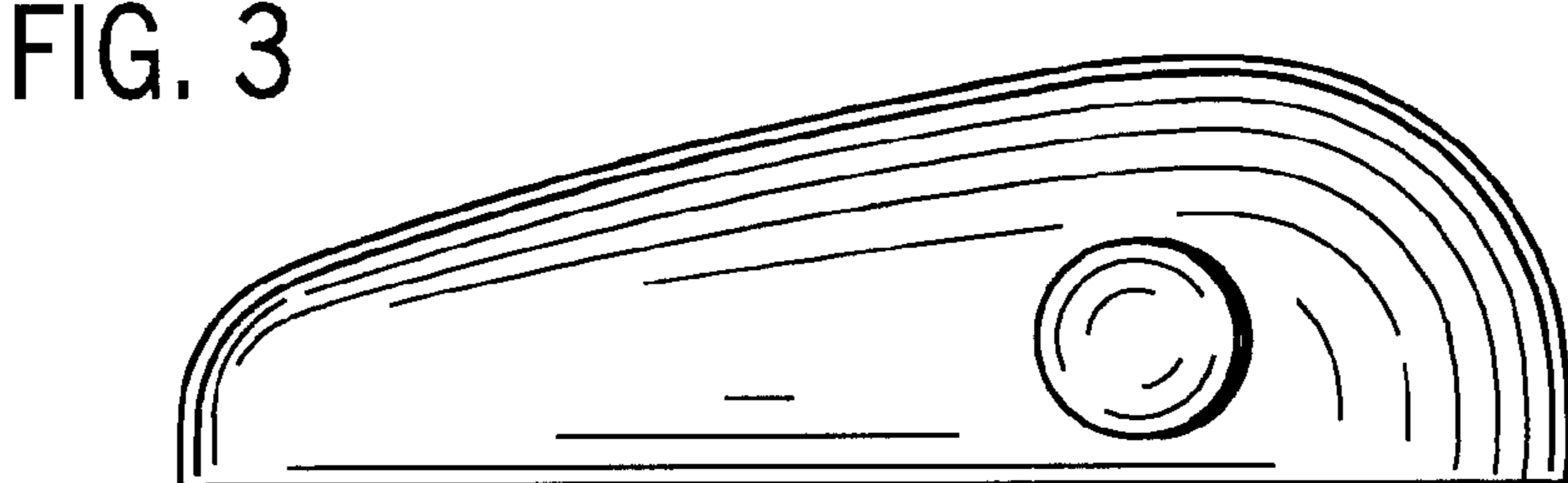
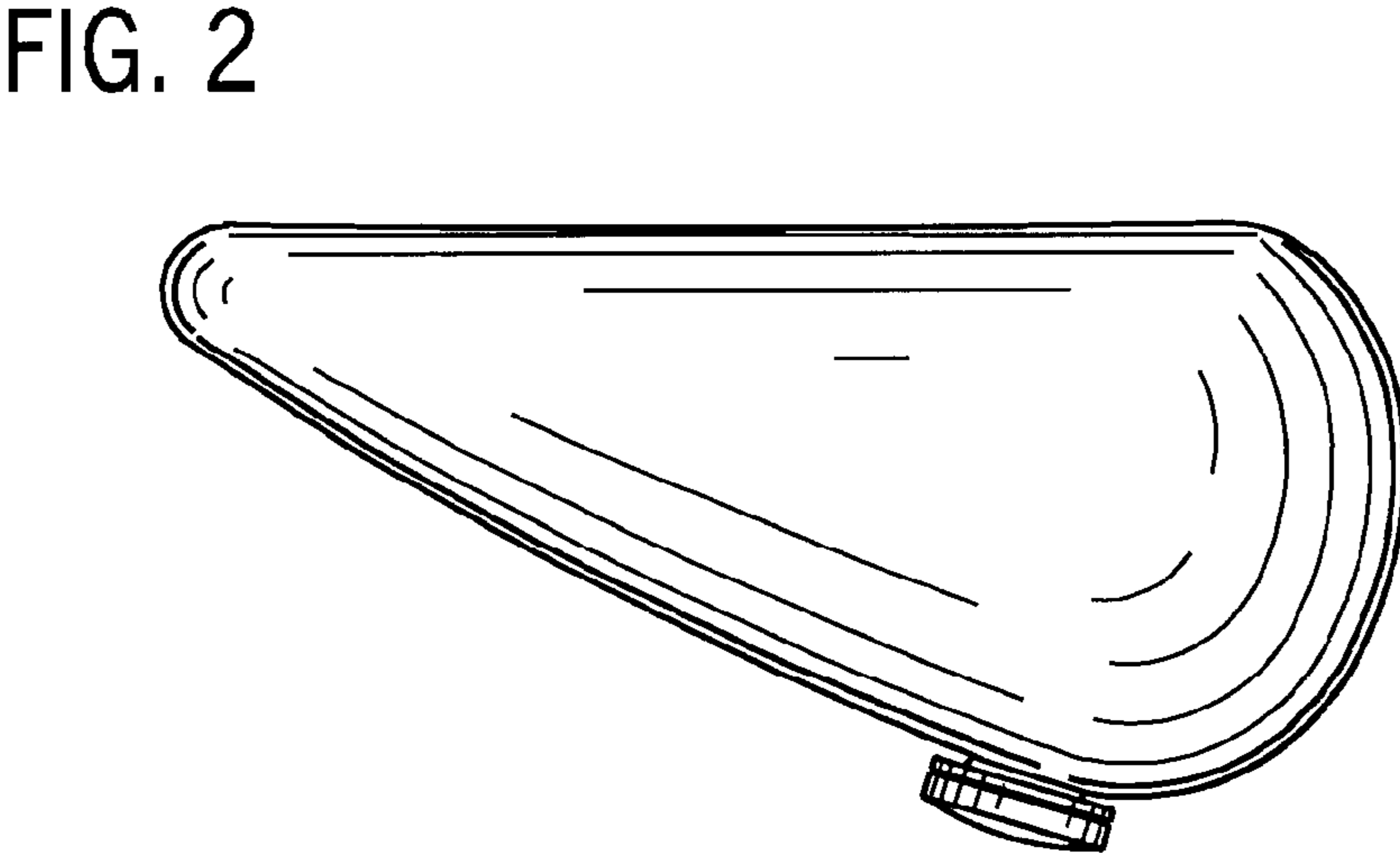
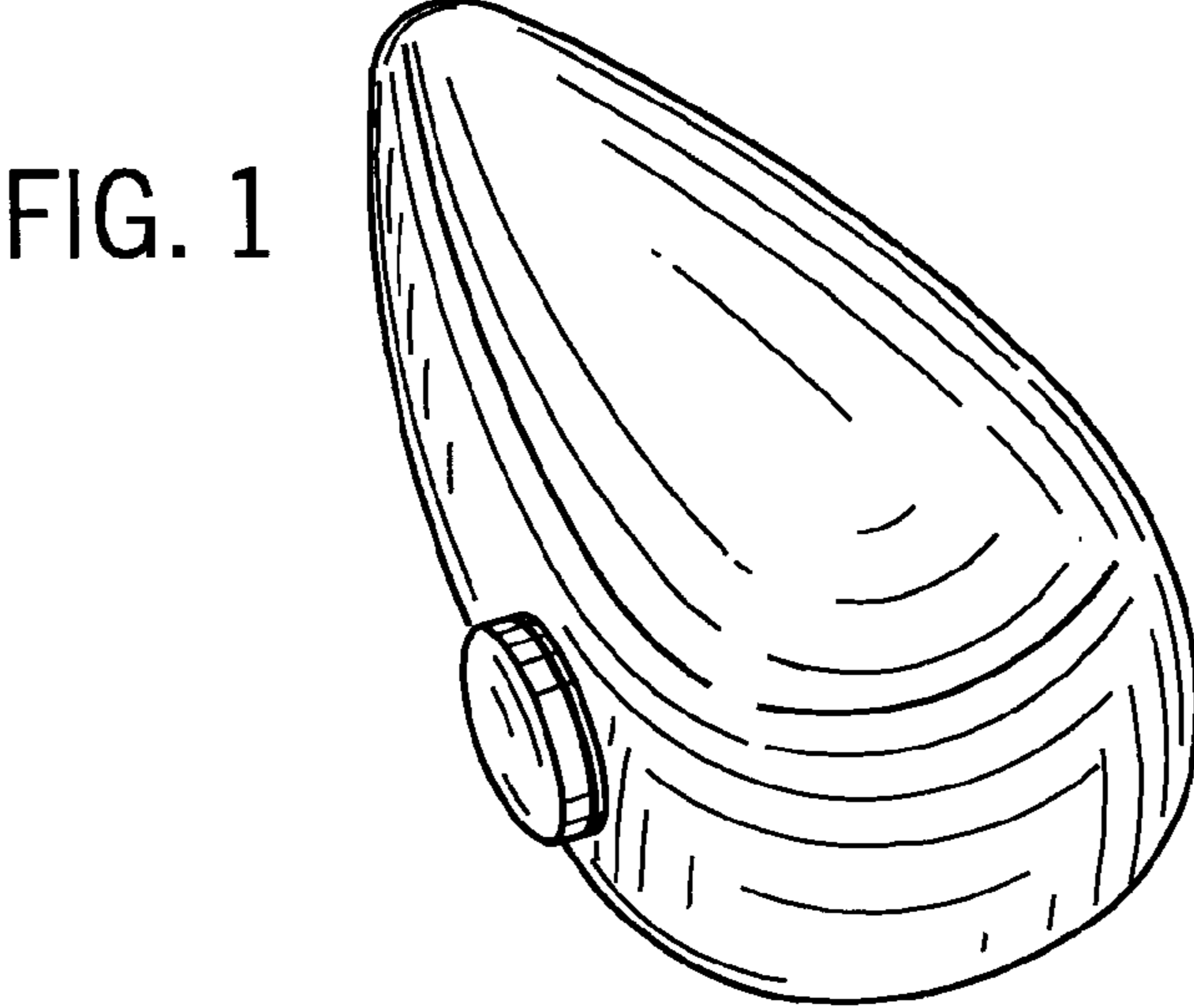

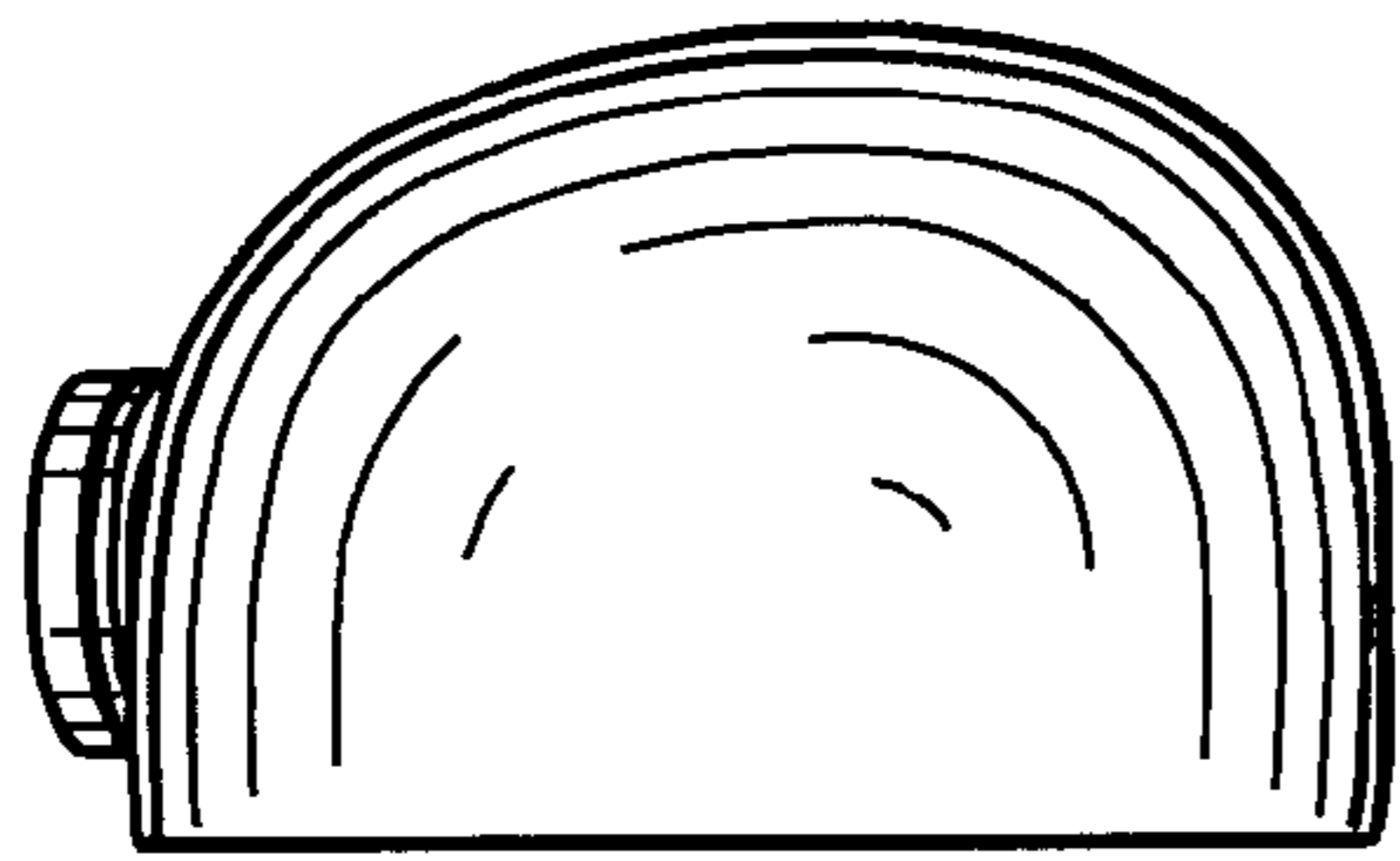

FIG. 4

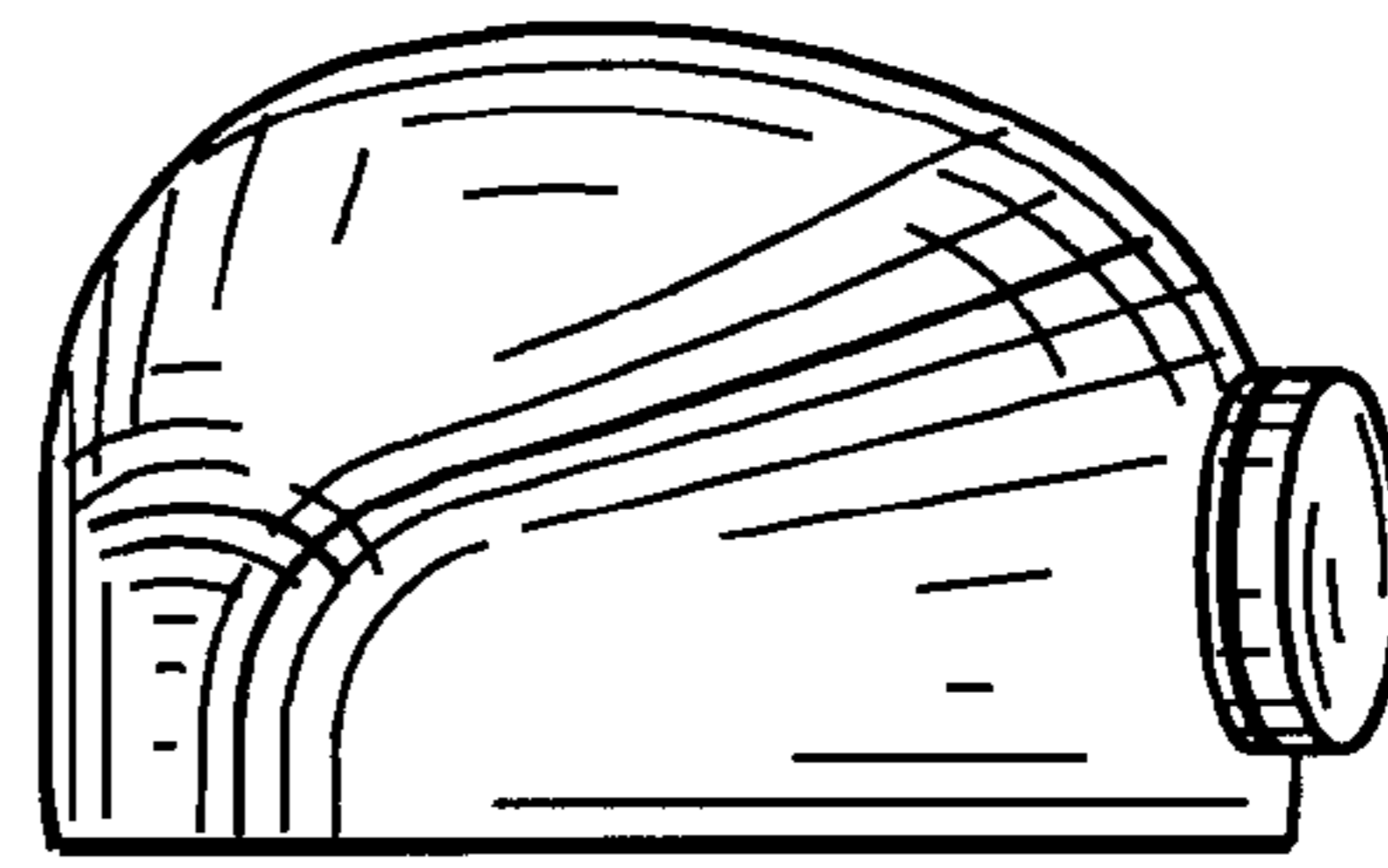

FIG. 5

FIG. 6

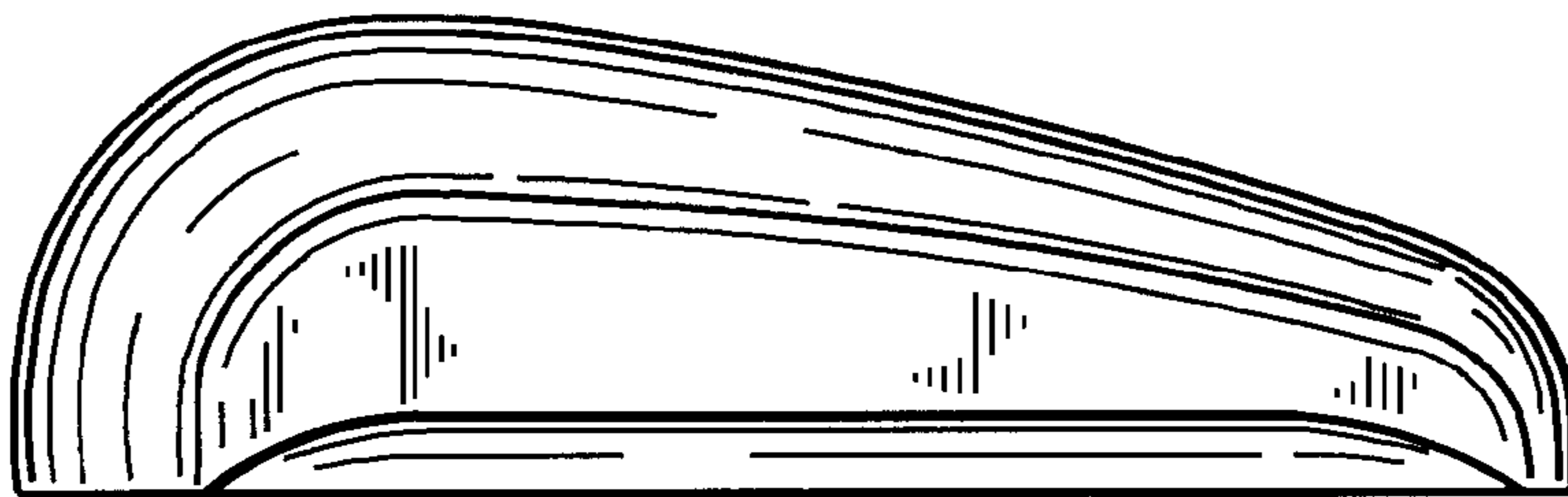
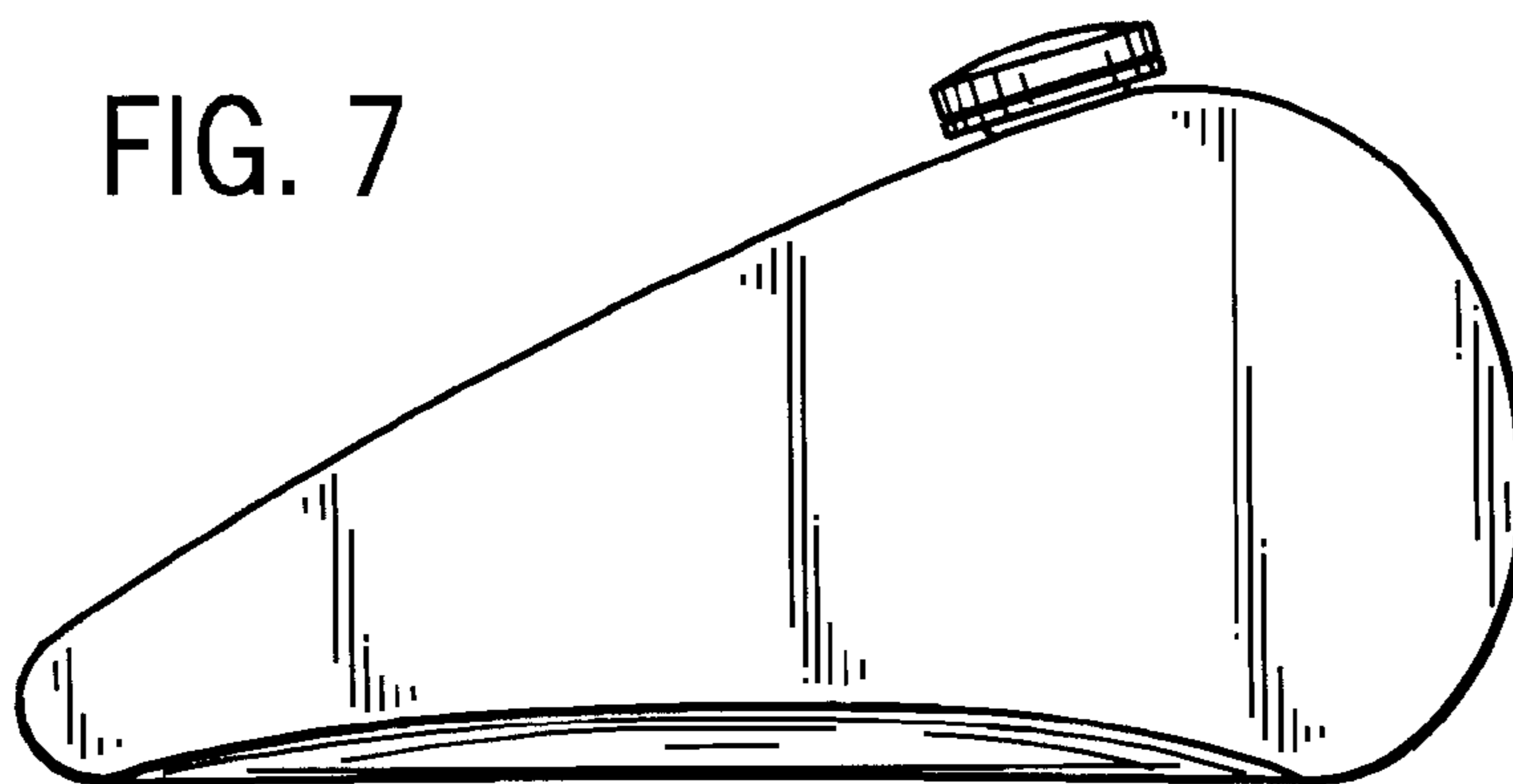

FIG. 7



UNITED STATES PATENT AND TRADEMARK OFFICE
CERTIFICATE OF CORRECTION

PATENT NO. : Des. 511,604 S
APPLICATION NO. : 29/215906
DATED : November 15, 2005
INVENTOR(S) : James G. Moritz and Ronald D. Winkler

Page 1 of 1

It is certified that error appears in the above-identified patent and that said Letters Patent is hereby corrected as shown below:

Cover Sheet insert name of Assignee therefor --WM Motorcycle Memorials, Inc.--

Signed and Sealed this

Fourth Day of July, 2006

A handwritten signature in black ink on a light gray dotted background. The signature reads "Jon W. Dudas" in a cursive style.

JON W. DUDAS

Director of the United States Patent and Trademark Office



US00D511604C1

(12) **EX PARTE REEXAMINATION CERTIFICATE** (8694th)
United States Patent
Moritz et al.

(10) **Number:** **US D511,604 C1**
(45) **Certificate Issued:** **Nov. 22, 2011**

(54) **CREMATION URN WITH MOTORCYCLE
GAS TANK SHAPE**

(75) Inventors: **James G. Moritz**, Greenfield, WI (US);
Ronald D. Winkler, Henderson, NV
(US)

(73) Assignee: **WM Motorcycle Memorials, Inc.**,
Henderson, NV (US)

Reexamination Request:

No. 90/009,219, Aug. 20, 2008

Reexamination Certificate for:

Patent No.: **Des. 511,604**
Issued: **Nov. 15, 2005**
Appl. No.: **29/215,906**
Filed: **Oct. 26, 2004**

Certificate of Correction issued Jul. 4, 2006.

(51) **LOC (9) Cl.** 06-04

(52) **U.S. Cl.** **D99/5**

(58) **Field of Classification Search** D12/110,
D12/114, 218; D99/5, 30; 180/219; 280/833-835
See application file for complete search history.

(56) **References Cited**

To view the complete listing of prior art documents cited during the proceeding for Reexamination Control Number 90/009,219, please refer to the USPTO's public Patent Application Information Retrieval (PAIR) system under the Display References tab.

Primary Examiner—Adir Aronovich

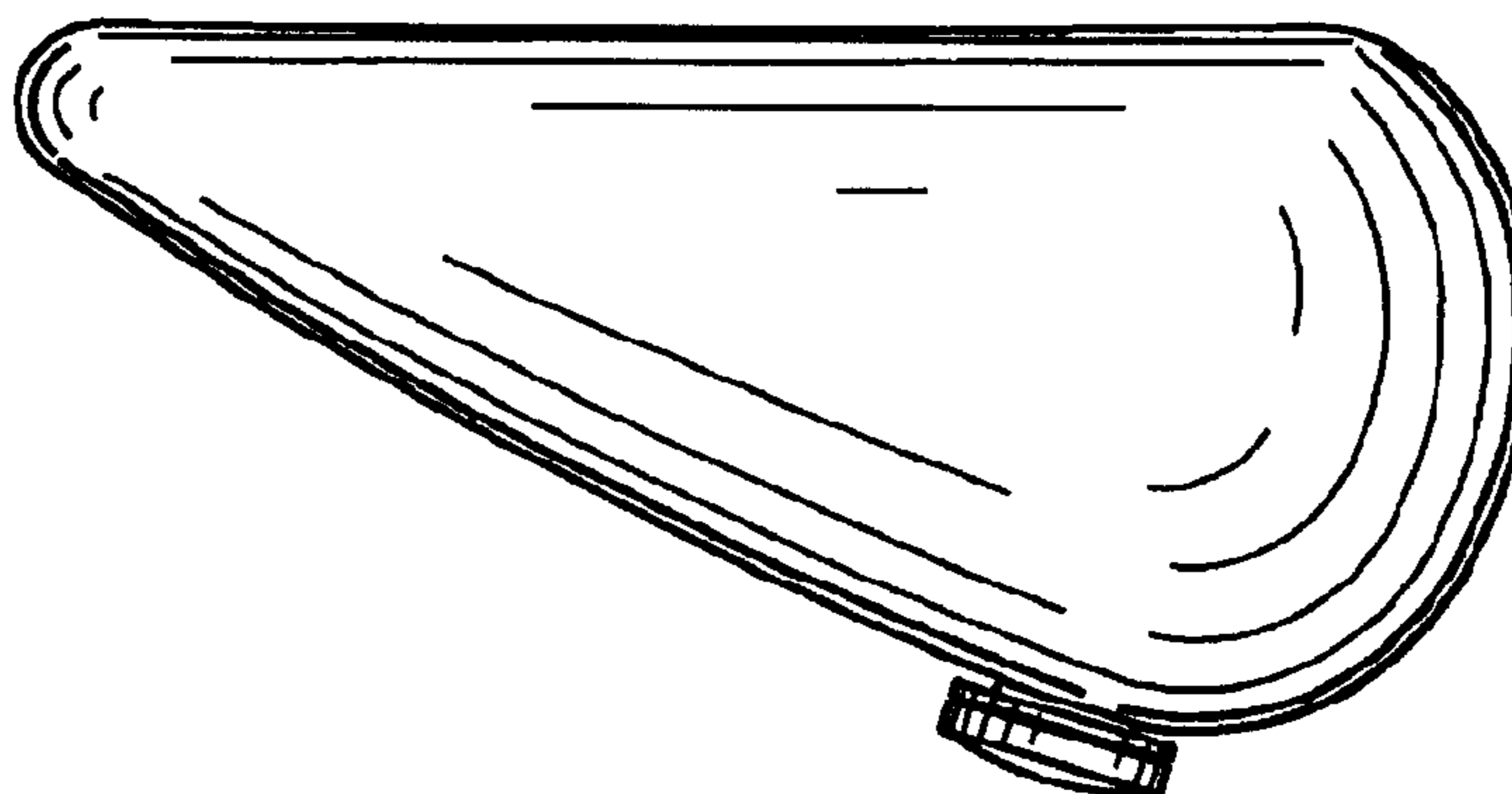
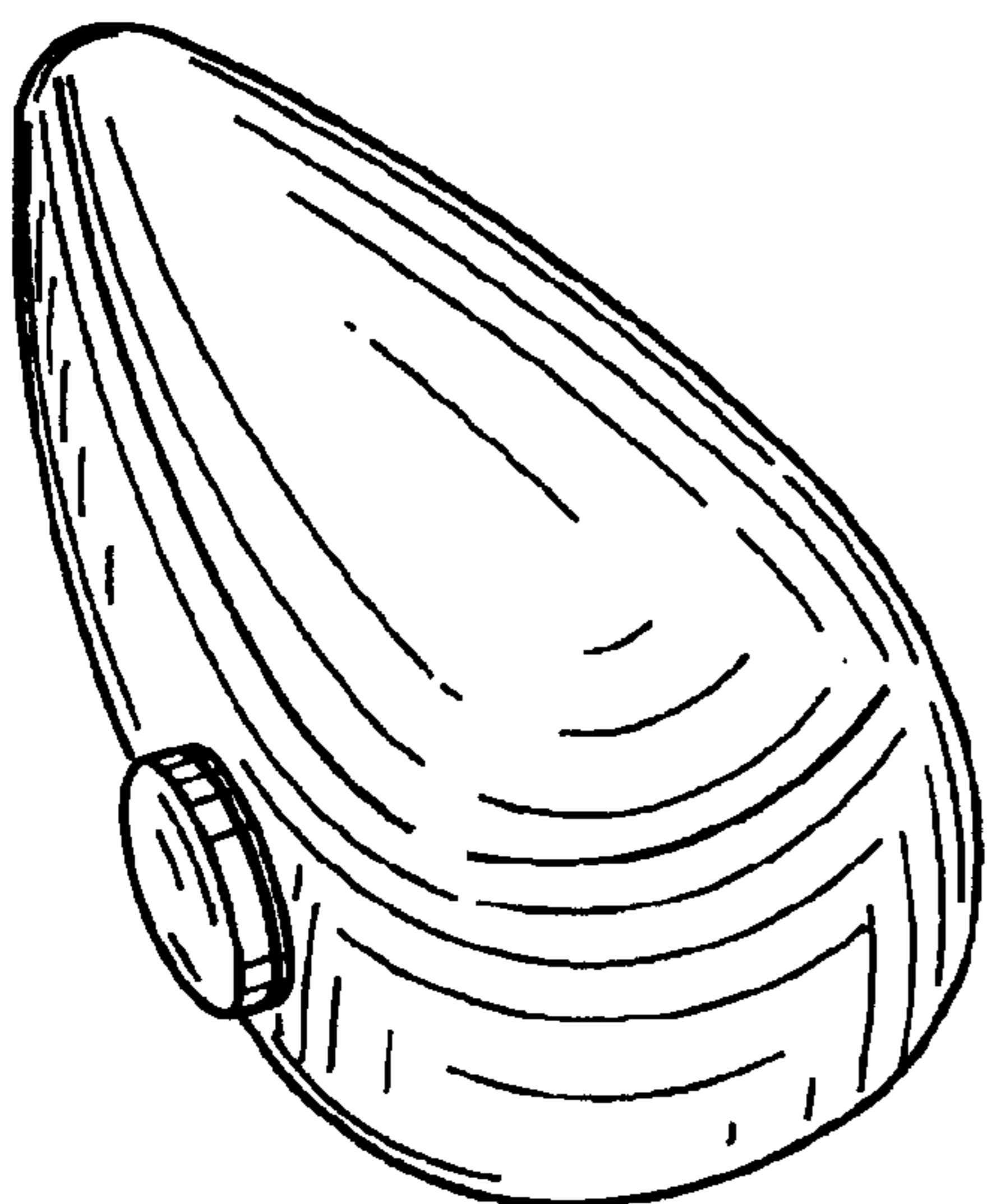

**EX PARTE
REEXAMINATION CERTIFICATE
ISSUED UNDER 35 U.S.C. 307**

AS A RESULT OF REEXAMINATION, IT HAS BEEN
DETERMINED THAT:

The sole claim is cancelled.

* * * * *