



US00D511567S

(12) **United States Design Patent**
Beahn

(10) **Patent No.:** **US D511,567 S**

(45) **Date of Patent:** **** Nov. 15, 2005**

(54) **BATH TUB**

(75) **Inventor:** **James W. Beahn**, 5151 4th St. North,
Lot 319, St. Petersburg, FL (US) 33703

(73) **Assignees:** **Robert A. Beahn**, Westminster, CA
(US); **James W. Beahn**, St. Petersburg,
FL (US)

(**) **Term:** **14 Years**

(21) **Appl. No.:** **29/217,144**

(22) **Filed:** **Nov. 12, 2004**

(51) **LOC (8) Cl.** **23-02**

(52) **U.S. Cl.** **D23/279**

(58) **Field of Search** D23/270, 273,
D23/275-277, 280.1-280.4, 303, 304; 4/538-539,
541.1, 553, 584, 663, 555-556; D24/204-205;
D25/2

(56) **References Cited**

U.S. PATENT DOCUMENTS

2,456,275 A * 12/1948 Harris 4/556
2,977,604 A * 4/1961 Miller 4/556
3,380,078 A * 4/1968 Hanson 4/555

D326,508 S * 5/1992 Sauter et al. D23/279
D352,099 S * 11/1994 Andersen D23/279
D388,880 S * 1/1998 DeFilippo D25/2
6,101,642 A * 8/2000 Auten et al. 4/580

OTHER PUBLICATIONS

BathEase various models shown in two page brochure, ©
1989.*

* cited by examiner

Primary Examiner—Robert A. Delehanty

(74) *Attorney, Agent, or Firm*—Pendorf & Cutliff

(57) **CLAIM**

The ornamental design for a bath tub, as shown and
described.

DESCRIPTION

FIG. 1 is a frontal perspective view thereof;
FIG. 2 is a front view thereof;
FIG. 3 is a rear view thereof;
FIG. 4 is a top view thereof; and,
FIG. 5 is bottom view thereof.
FIG. 6 a right side view of thereof; and,
FIG. 7 is a left side view of thereof.

1 Claim, 4 Drawing Sheets

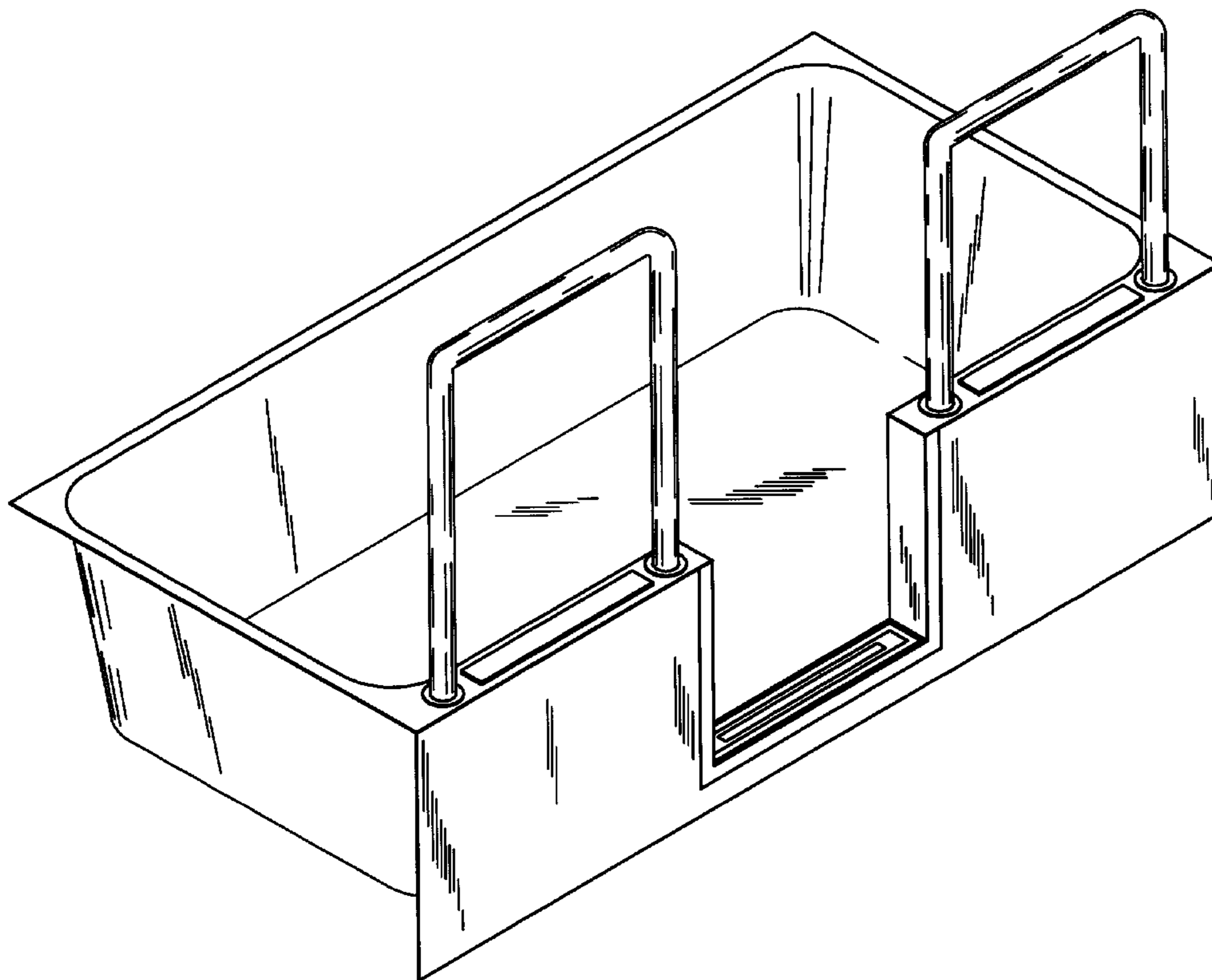

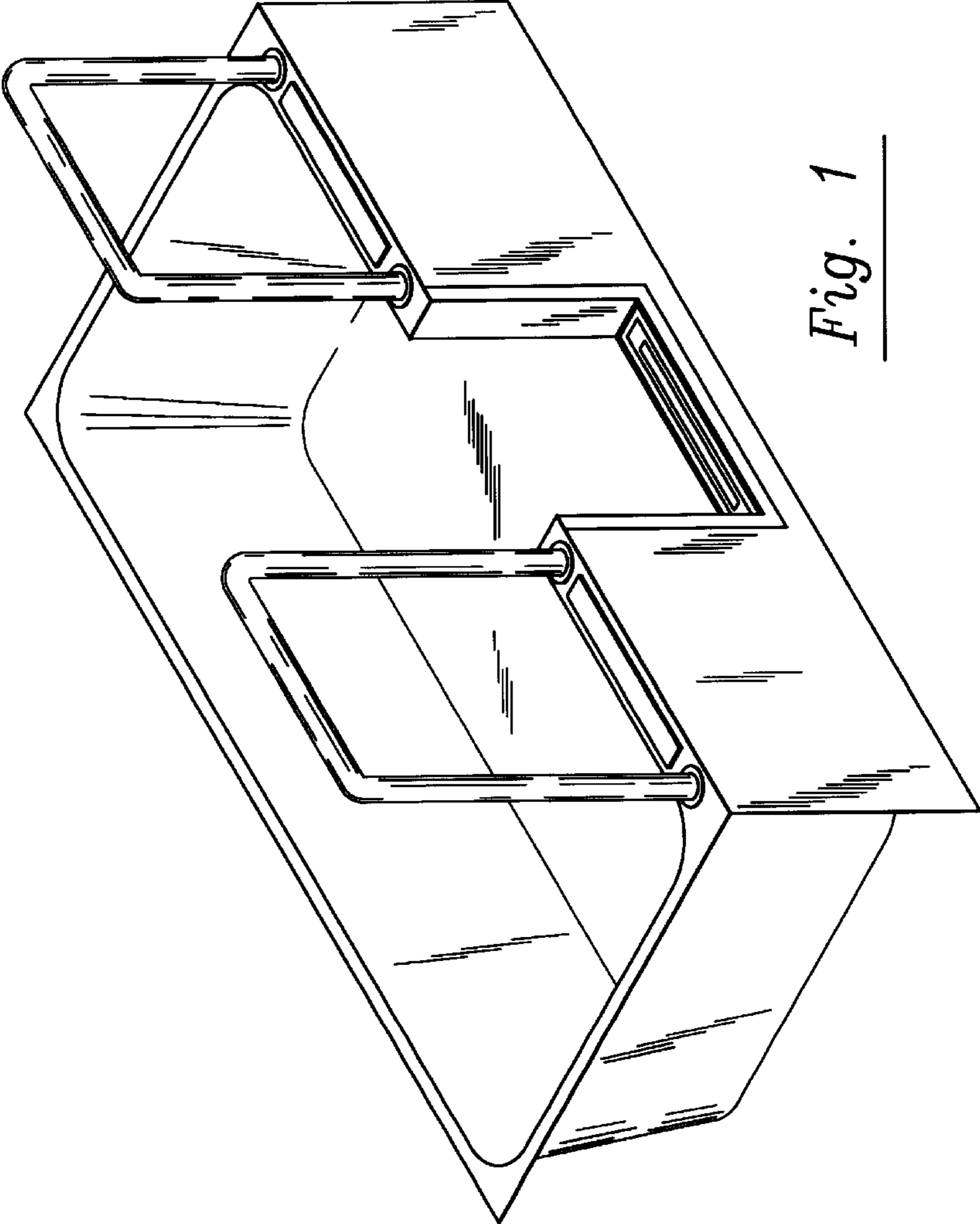

Fig. 1

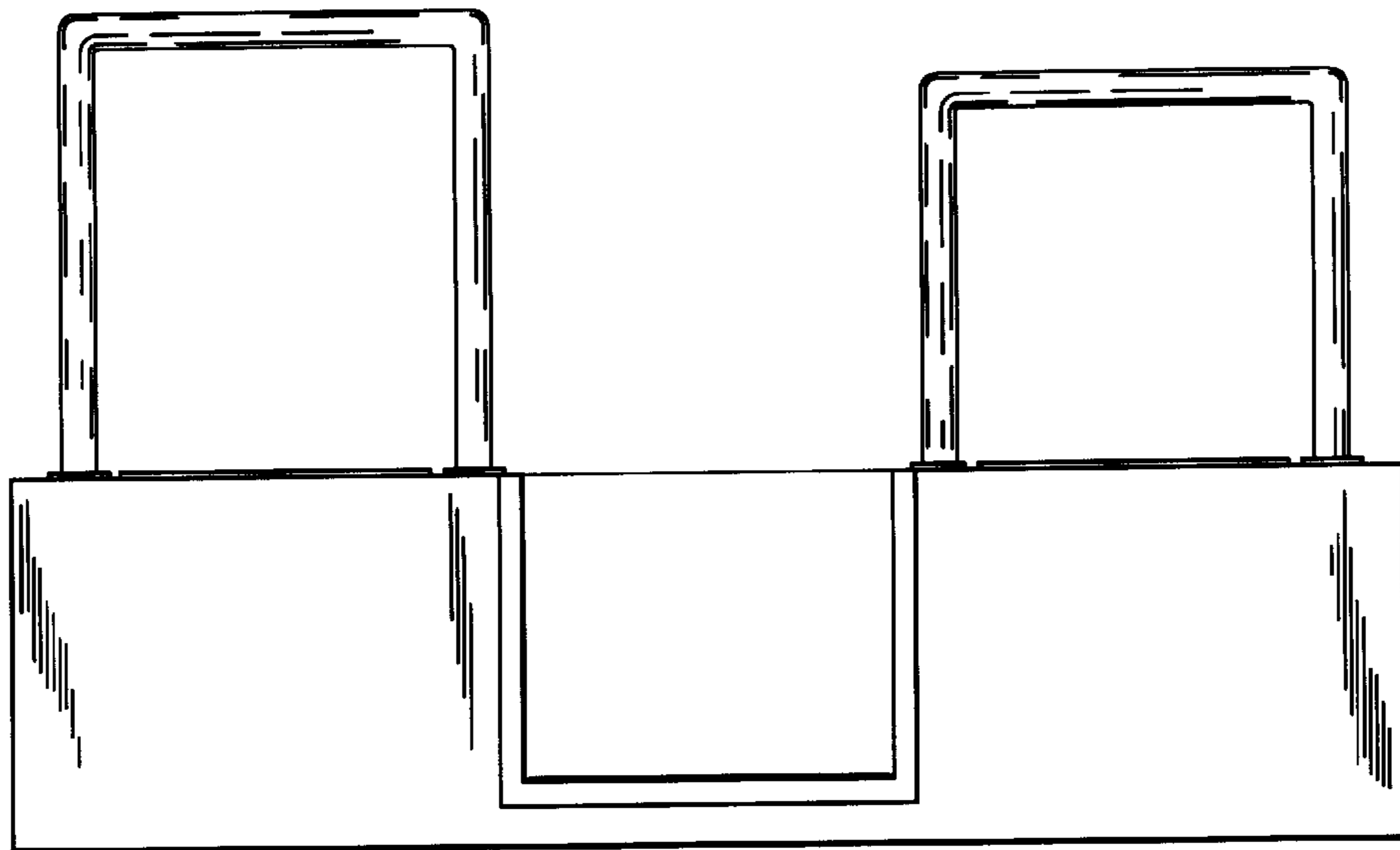

Fig. 2

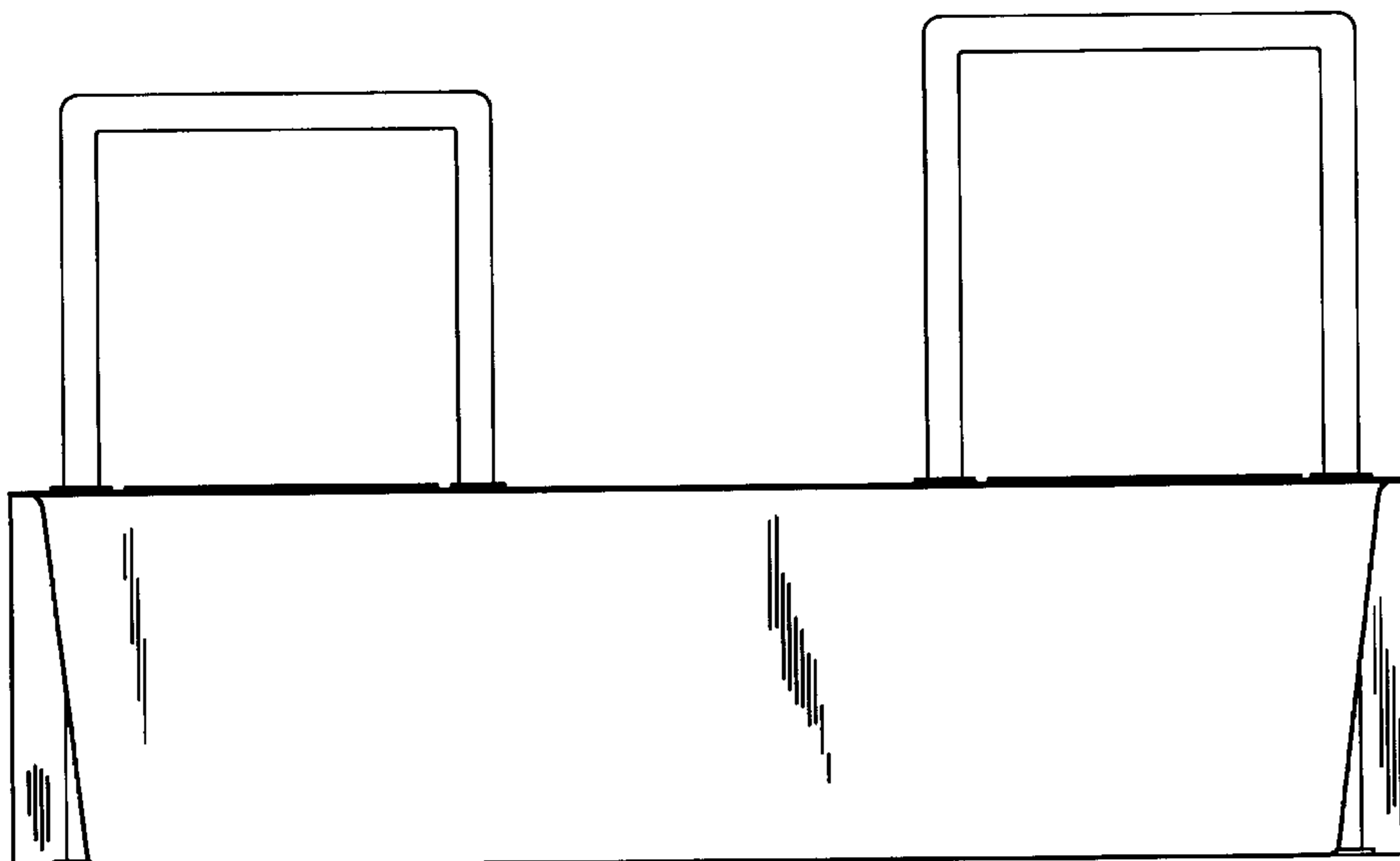

Fig. 3

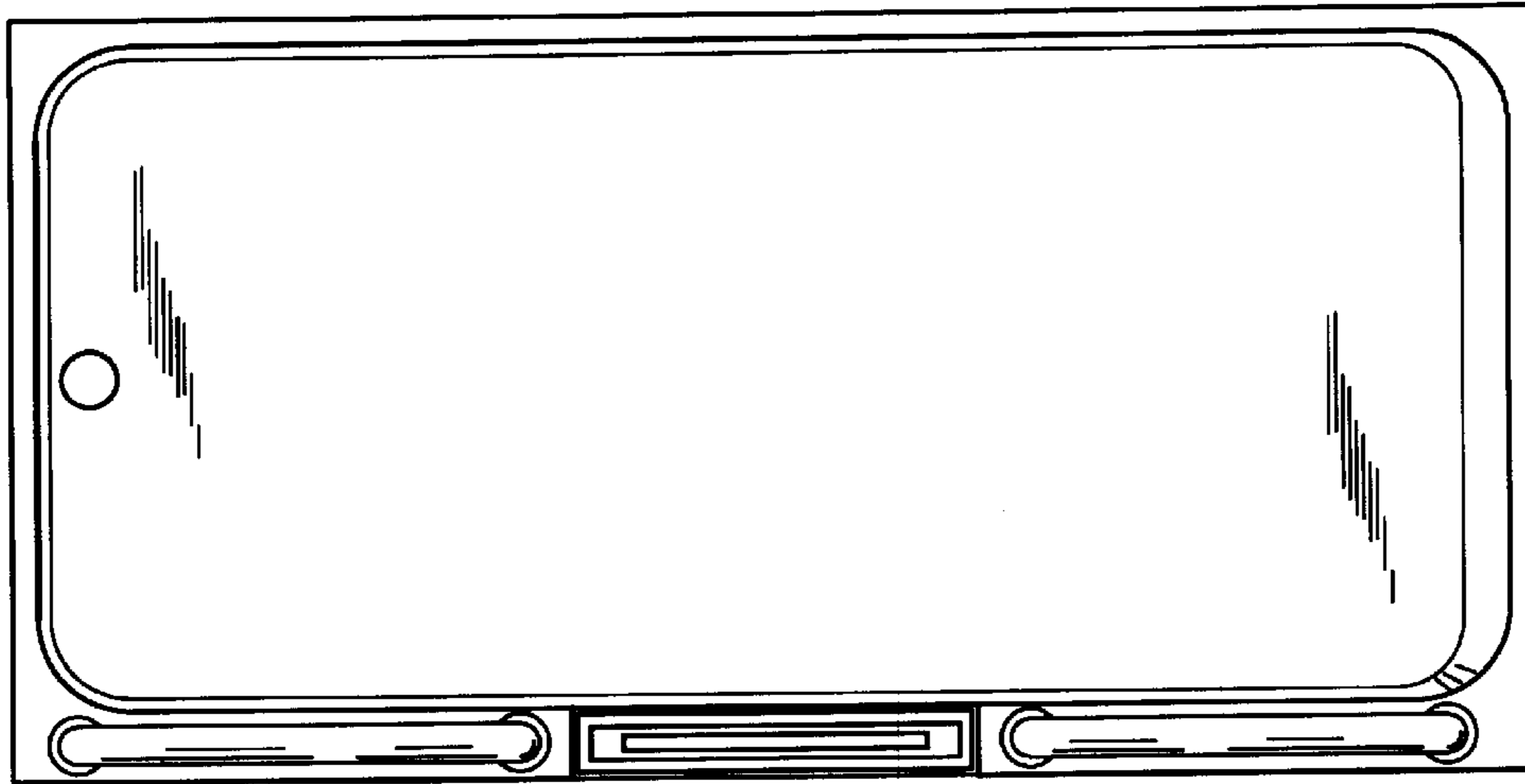

Fig. 4

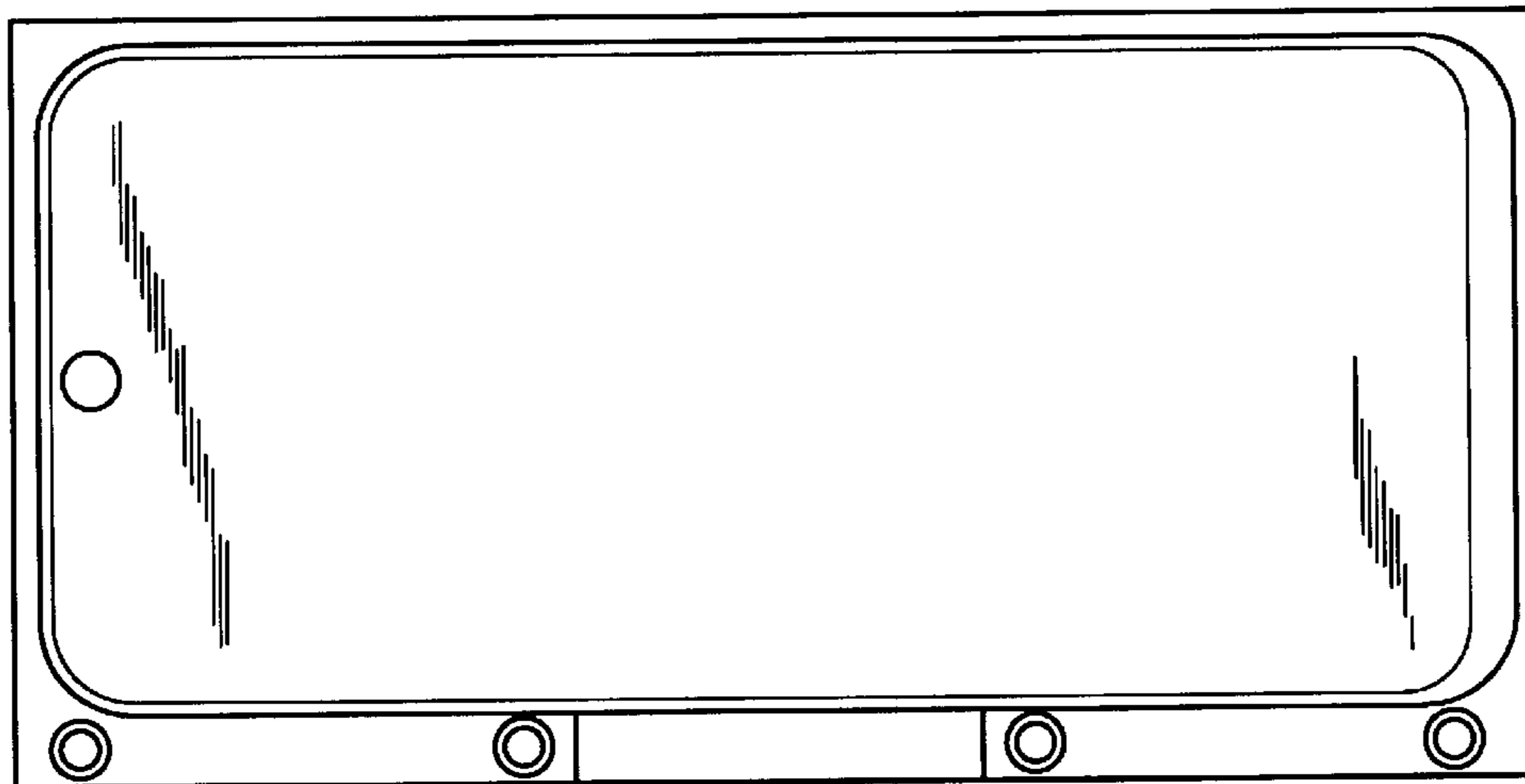

Fig. 5

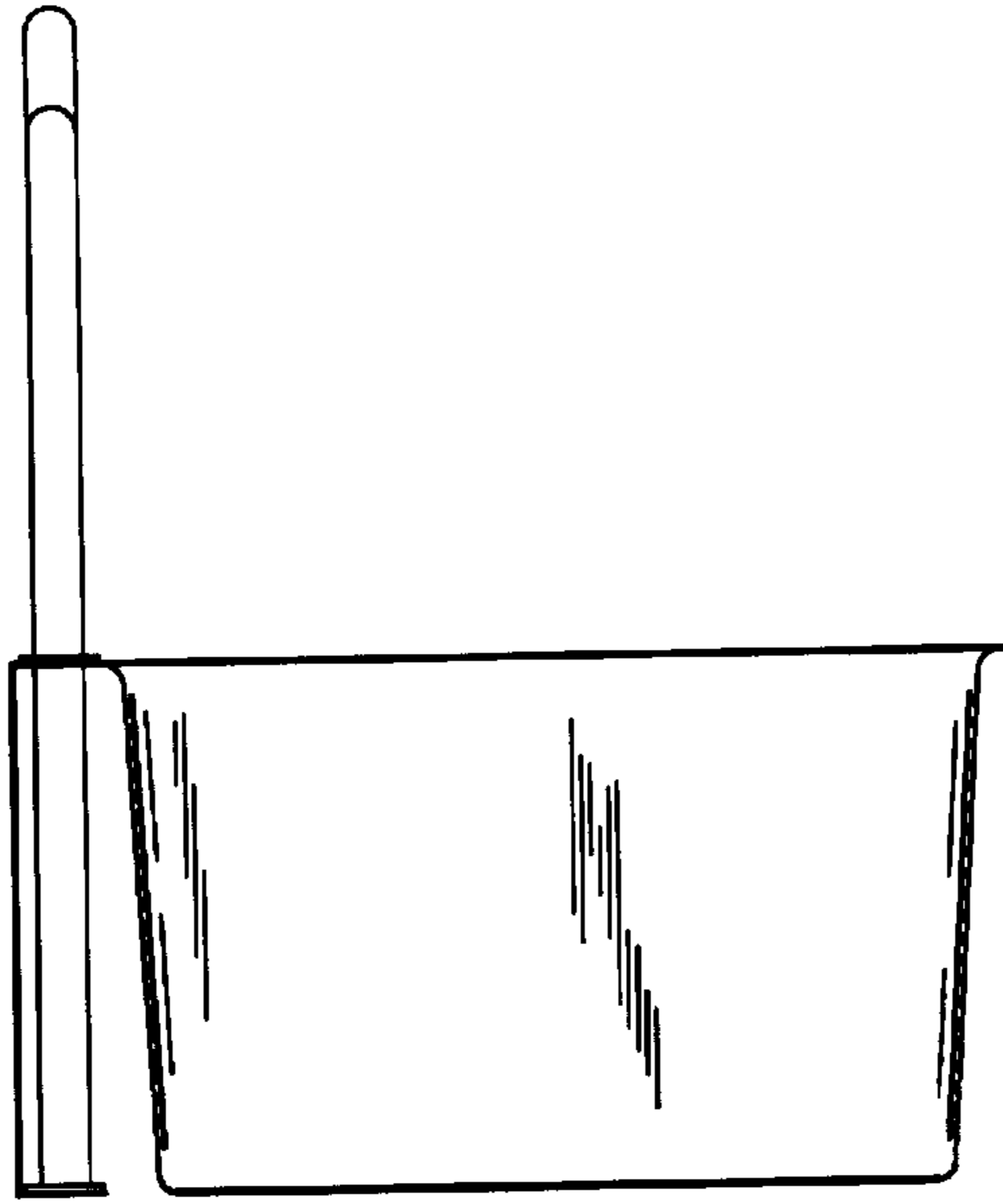

Fig. 6

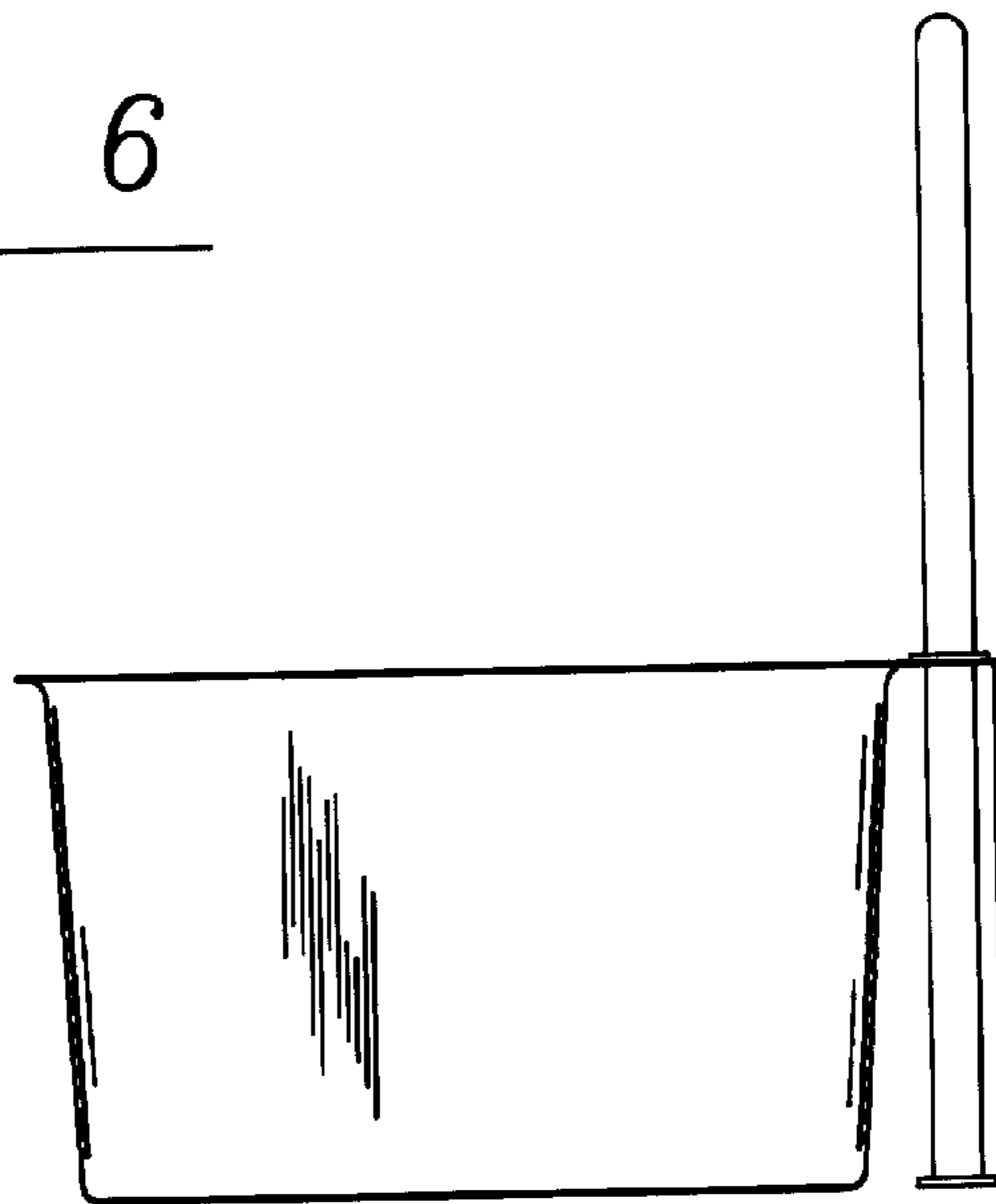

Fig. 7