



US00D511520S

(12) **United States Design Patent** (10) **Patent No.:** **US D511,520 S**
Hussaini et al. (45) **Date of Patent:** **** Nov. 15, 2005**

(54) **DOCKING STATION FOR AN ELECTRONIC DEVICE**

Primary Examiner—M. H. Tung

(75) Inventors: **Saied Hussaini**, Miami, FL (US); **Marc Iacovelli**, Miami, FL (US)

(74) *Attorney, Agent, or Firm*—Berenato, White & Stavish LLC

(73) Assignee: **Intec, Inc.**, Miami, FL (US)

(57) **CLAIM**

(**) Term: **14 Years**

The ornamental design for a docking station for an electronic device, as shown and described.

(21) Appl. No.: **29/186,614**

DESCRIPTION

(22) Filed: **Jul. 21, 2003**

(51) **LOC (8) Cl.** **14-02**

(52) **U.S. Cl.** **D14/434**

(58) **Field of Search** D14/432, 433, D14/434, 356-7; 361/681, 686, 687, 679-83, 724-7; D13/107-8

FIG. 1 is a front view of the docking station for an electronic device according to the present invention;
 FIG. 2 is a rear view of the docking station for an electronic device of FIG. 1;
 FIG. 3 is a right side view of the docking station for an electronic device of FIG. 1;
 FIG. 4 is a left side view of the docking station for an electronic device of FIG. 1;
 FIG. 5 is a top view of the docking station for an electronic device of FIG. 1;
 FIG. 6 is a bottom view of the docking station for an electronic device of FIG. 1; and,
 FIG. 7 is a front and left perspective view of the docking station for an electronic device of FIG. 1.

(56) **References Cited**

U.S. PATENT DOCUMENTS

D363,274 S	*	10/1995	Pangburn	D14/434
D368,704 S	*	4/1996	Tanaka	D14/434
D376,585 S	*	12/1996	Wathen et al.	D14/434
D440,977 S	*	4/2001	Weisz et al.	D14/434
D487,897 S	*	3/2004	Huang et al.	D14/434

* cited by examiner

1 Claim, 7 Drawing Sheets

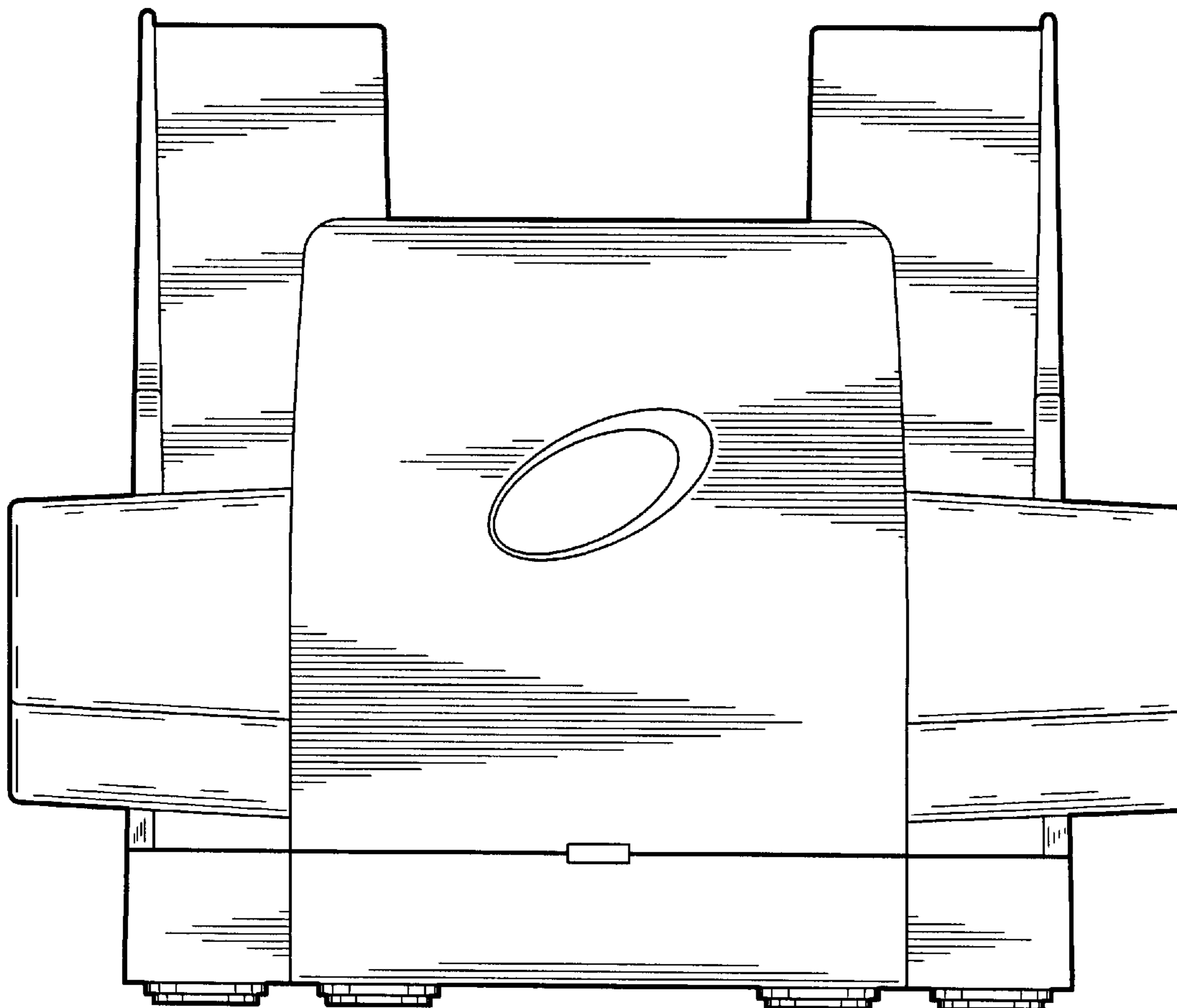

Fig. 1

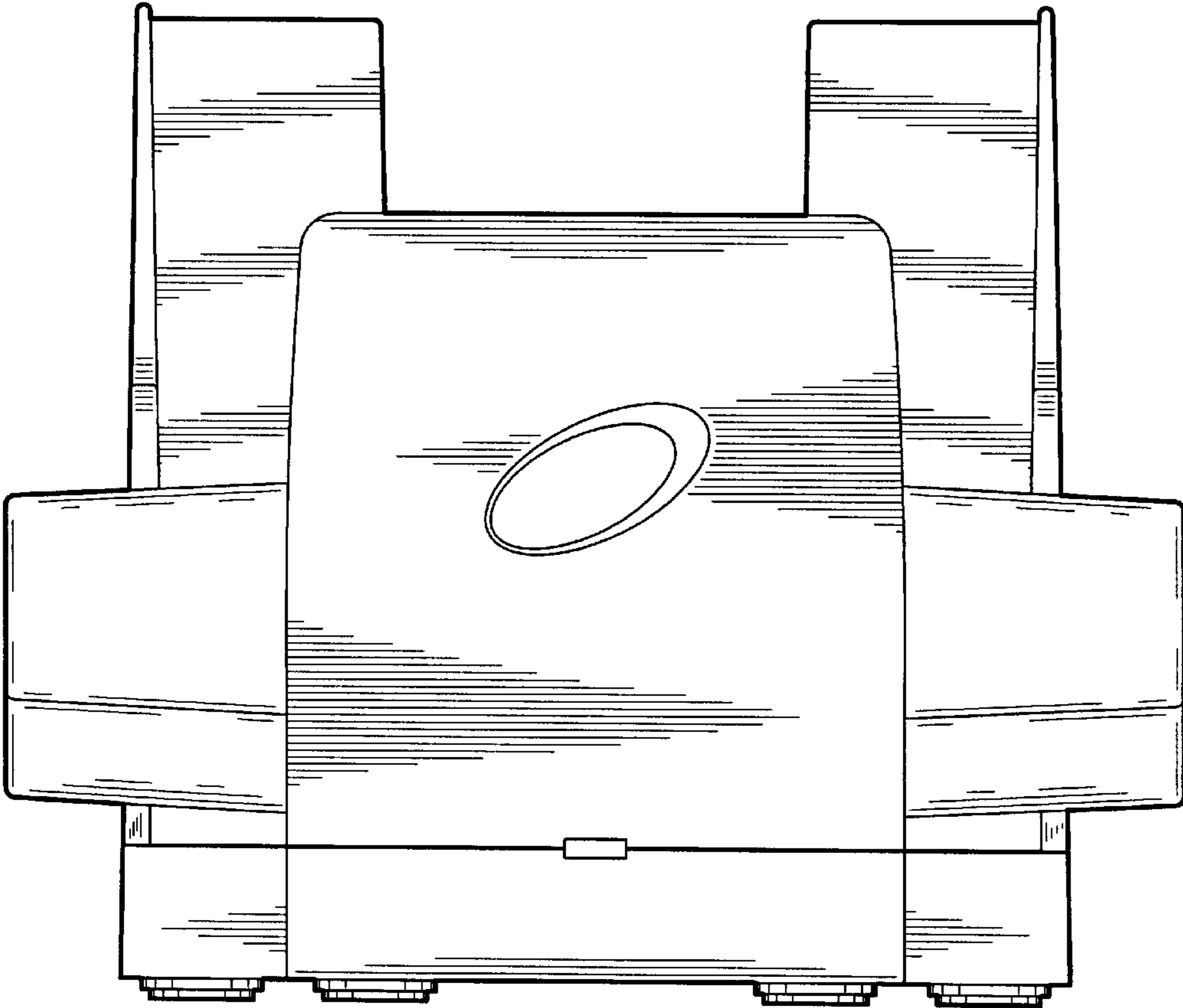

Fig. 2

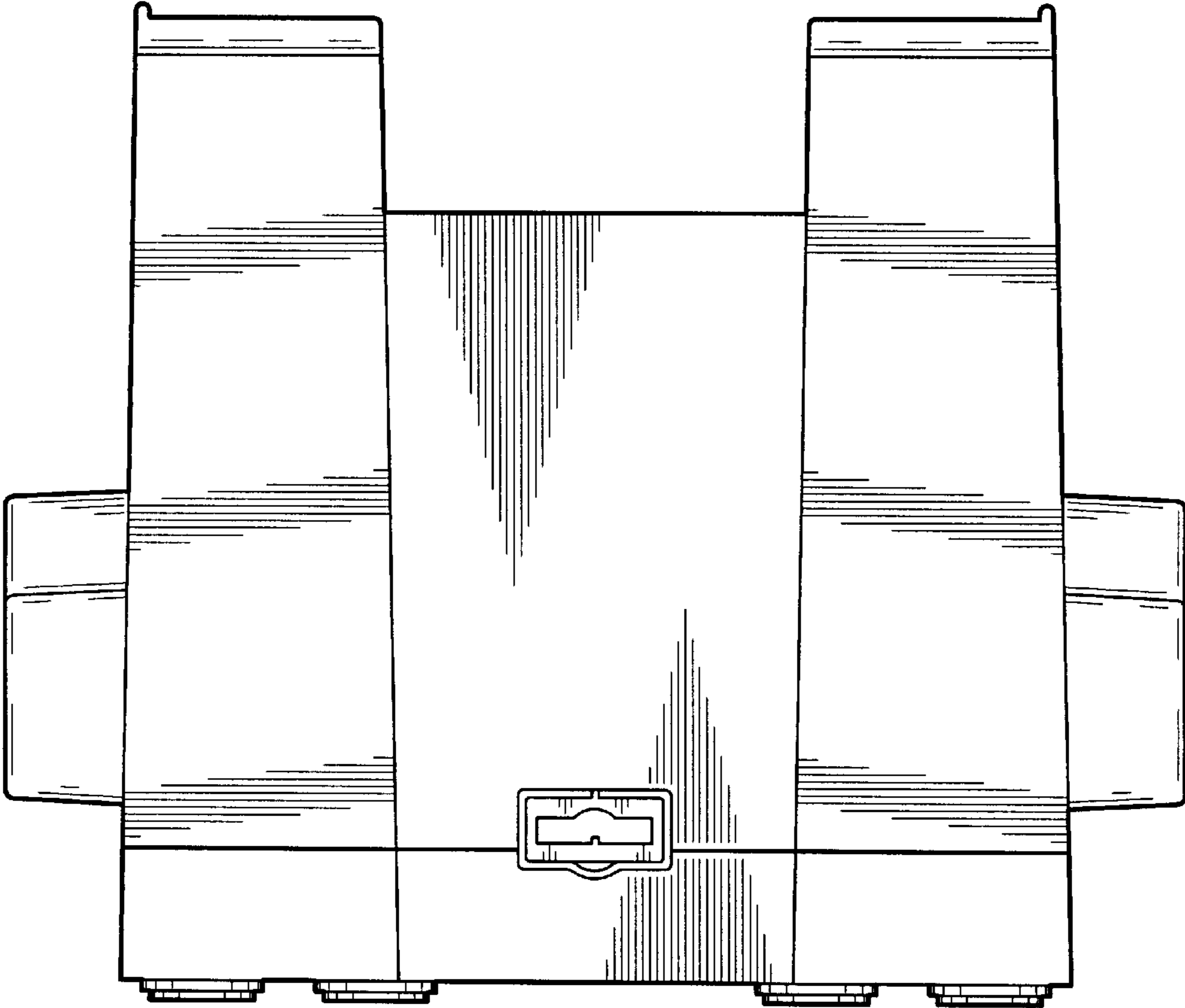

Fig. 3

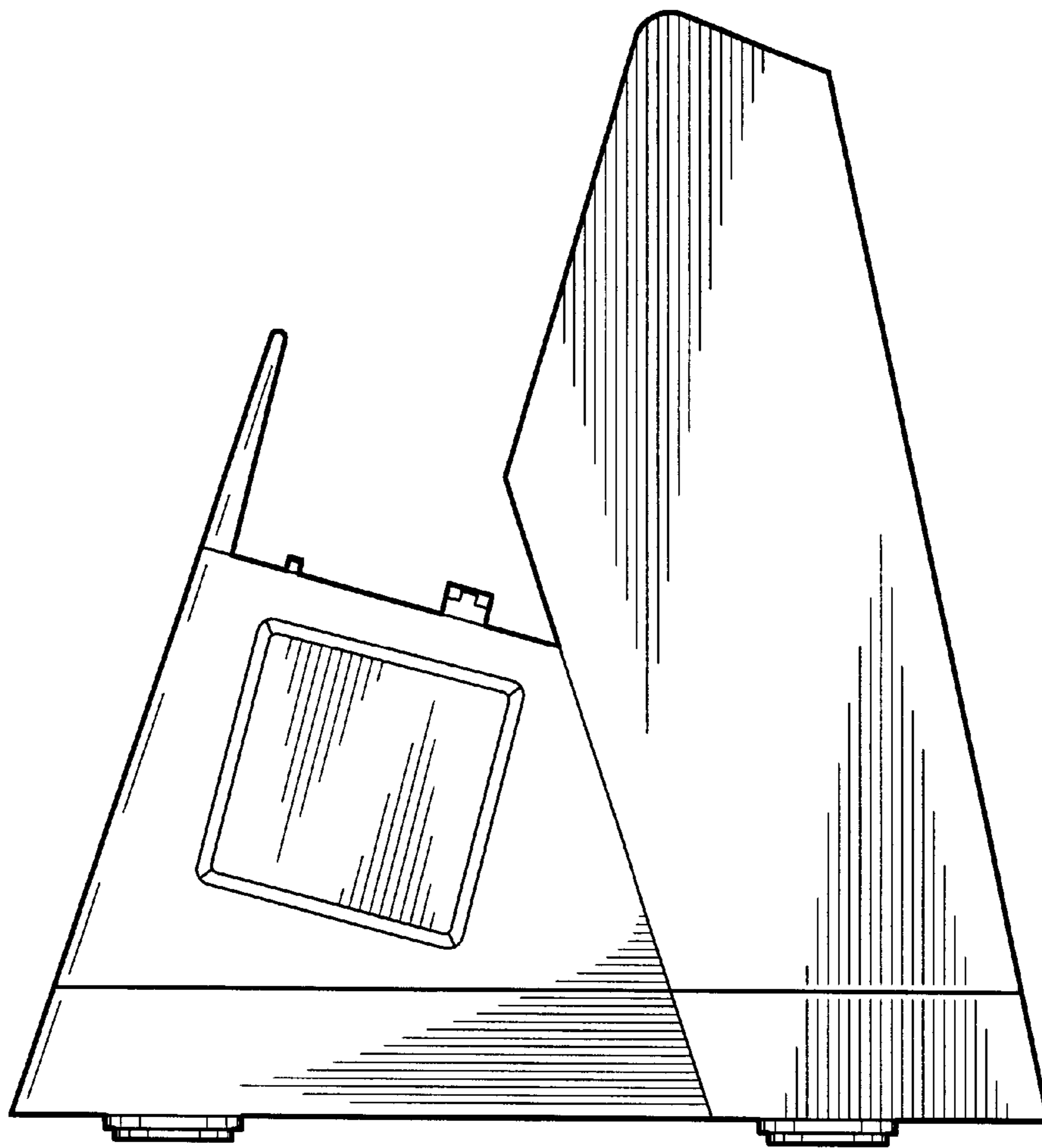

Fig. 4

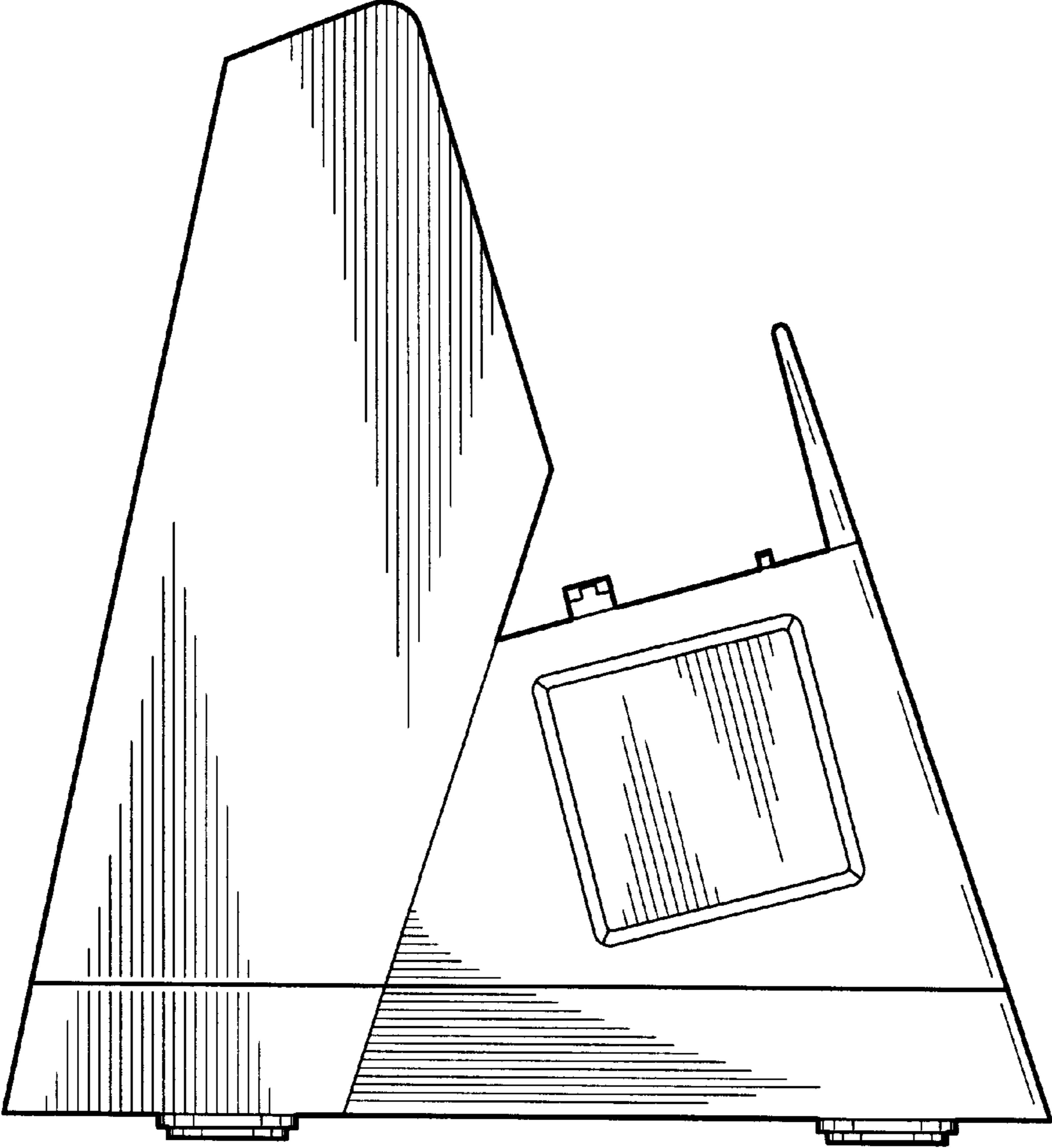

Fig. 5

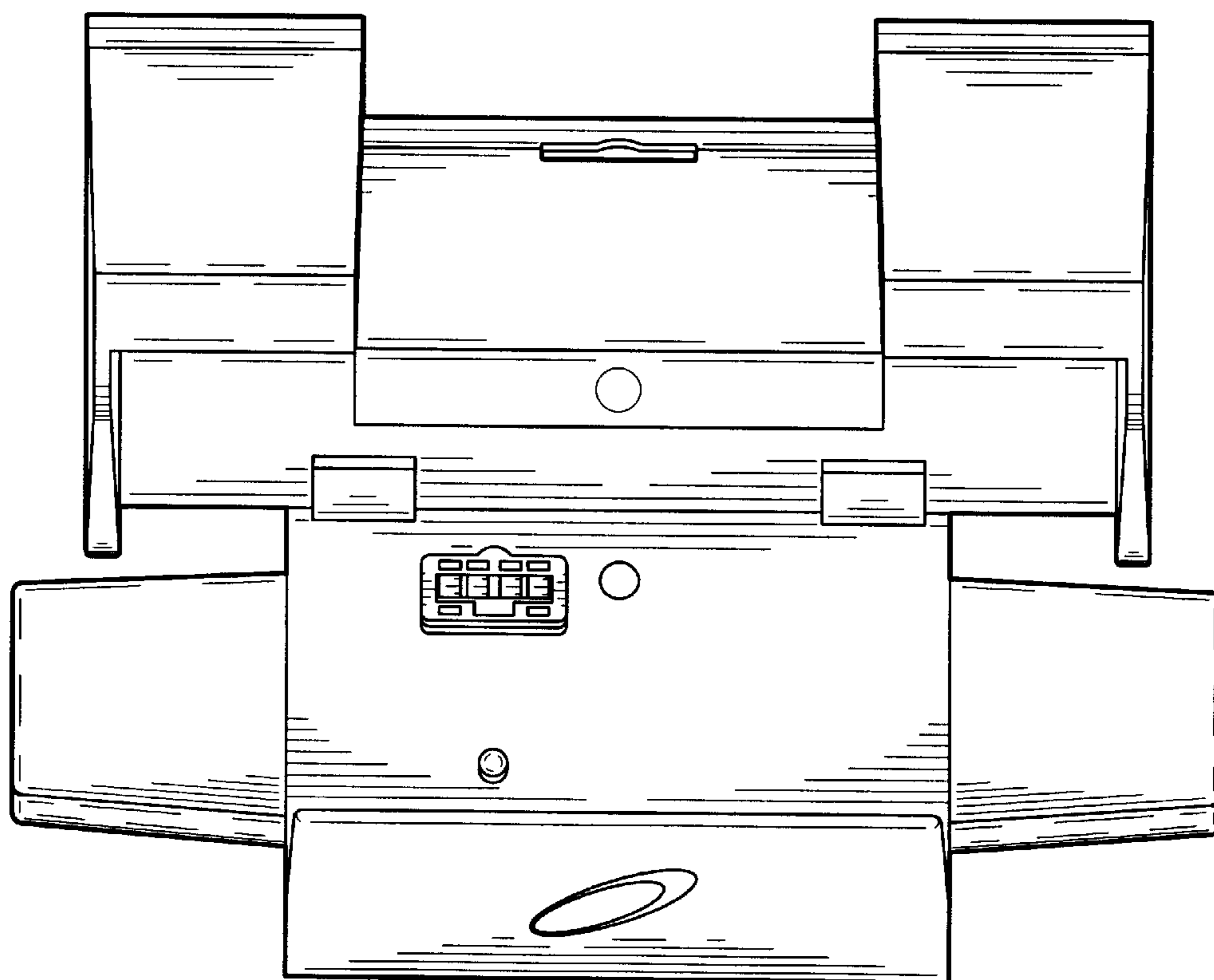

Fig. 6

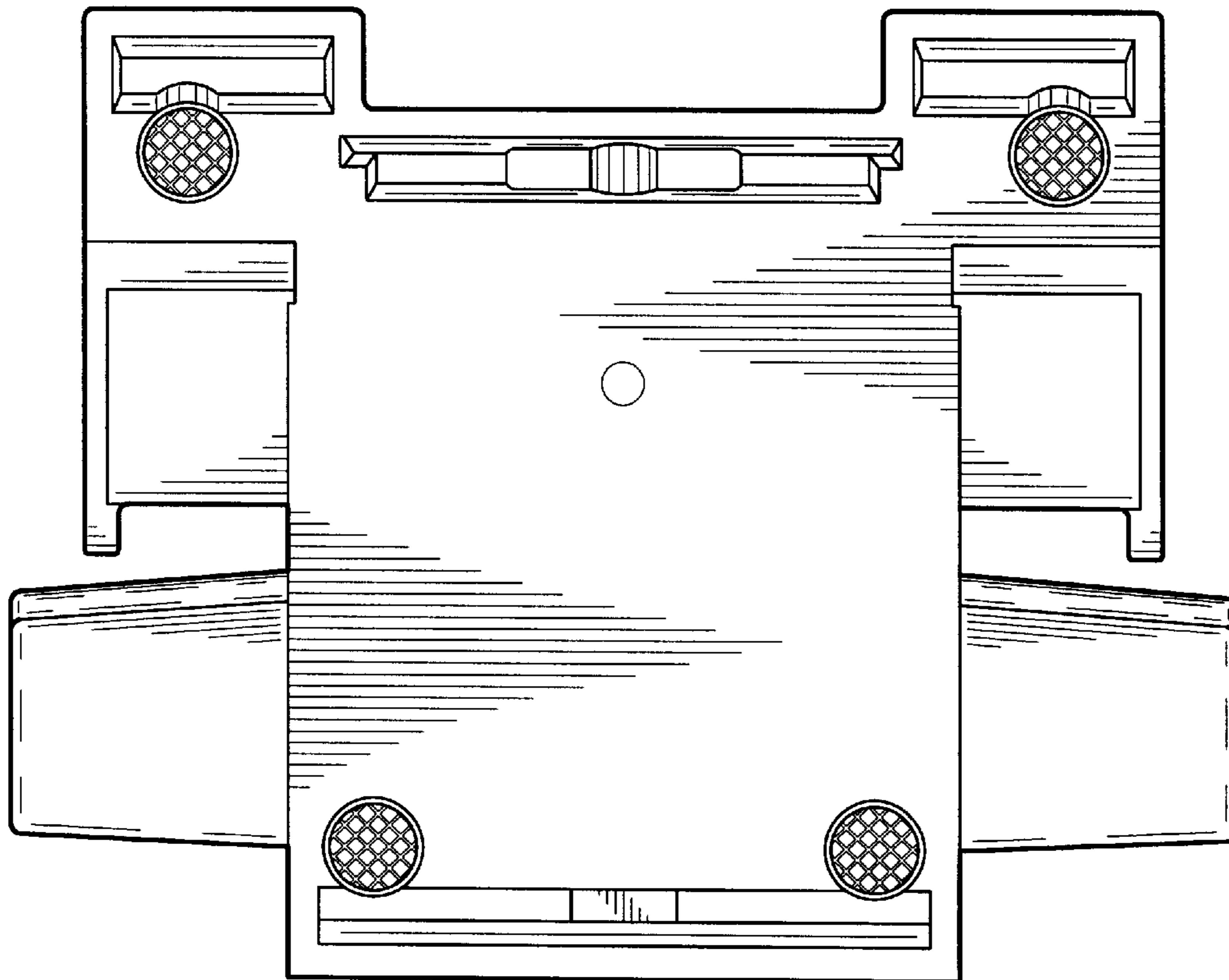

Fig. 7

