



US00D511421S

(12) **United States Design Patent**
Schultz

(10) **Patent No.:** **US D511,421 S**

(45) **Date of Patent:** **** Nov. 15, 2005**

(54) **CHAIR**

(76) **Inventor:** **Moses Richard Schultz**, 806 Gavel Pike, Palm, PA (US) 18070

(**) **Term:** **14 Years**

(21) **Appl. No.:** **29/135,955**

(22) **Filed:** **Jan. 21, 2001**

(51) **LOC (8) Cl.** **06-01**

(52) **U.S. Cl.** **D6/374; D6/375; D6/376**

(58) **Field of Search** **D6/334, 368, 370, D6/374, 375, 376, 380, 500-502; 297/445.1, 446.1**

(56) **References Cited**

U.S. PATENT DOCUMENTS

D153,162 S	*	3/1949	Nelems	D6/375
D181,241 S	*	10/1957	Swanson	D6/374
D265,151 S	*	6/1982	Roner	D6/368
D336,795 S	*	6/1993	Rowe et al.	D6/380
D341,038 S	*	11/1993	Danko	D6/375

D402,817 S	*	12/1998	Schultz	D6/374
D406,949 S	*	3/1999	Schultz	D6/374
D422,158 S	*	4/2000	Newhouse	D6/375
D426,970 S	*	6/2000	Kolberg	D6/374
D430,415 S	*	9/2000	Schultz	D6/374

* cited by examiner

Primary Examiner—Mimosa De

(74) *Attorney, Agent, or Firm*—Thomas A. O'Rourke

(57) **CLAIM**

The ornamental design for a chair, as shown and described.

DESCRIPTION

FIG. 1 is a side view of the chair of the present invention; FIG. 2 is a front view of the chair of FIG. 1; FIG. 3 is a top view of the chair illustrated in FIG. 1; FIG. 4 is a bottom view of the chair of the present invention; FIG. 5 is a rear view of the chair of the present invention; FIG. 6 is a front perspective view of the chair of FIG. 1; and, FIG. 7 is a rear perspective view of the chair of FIG. 1.

1 Claim, 7 Drawing Sheets

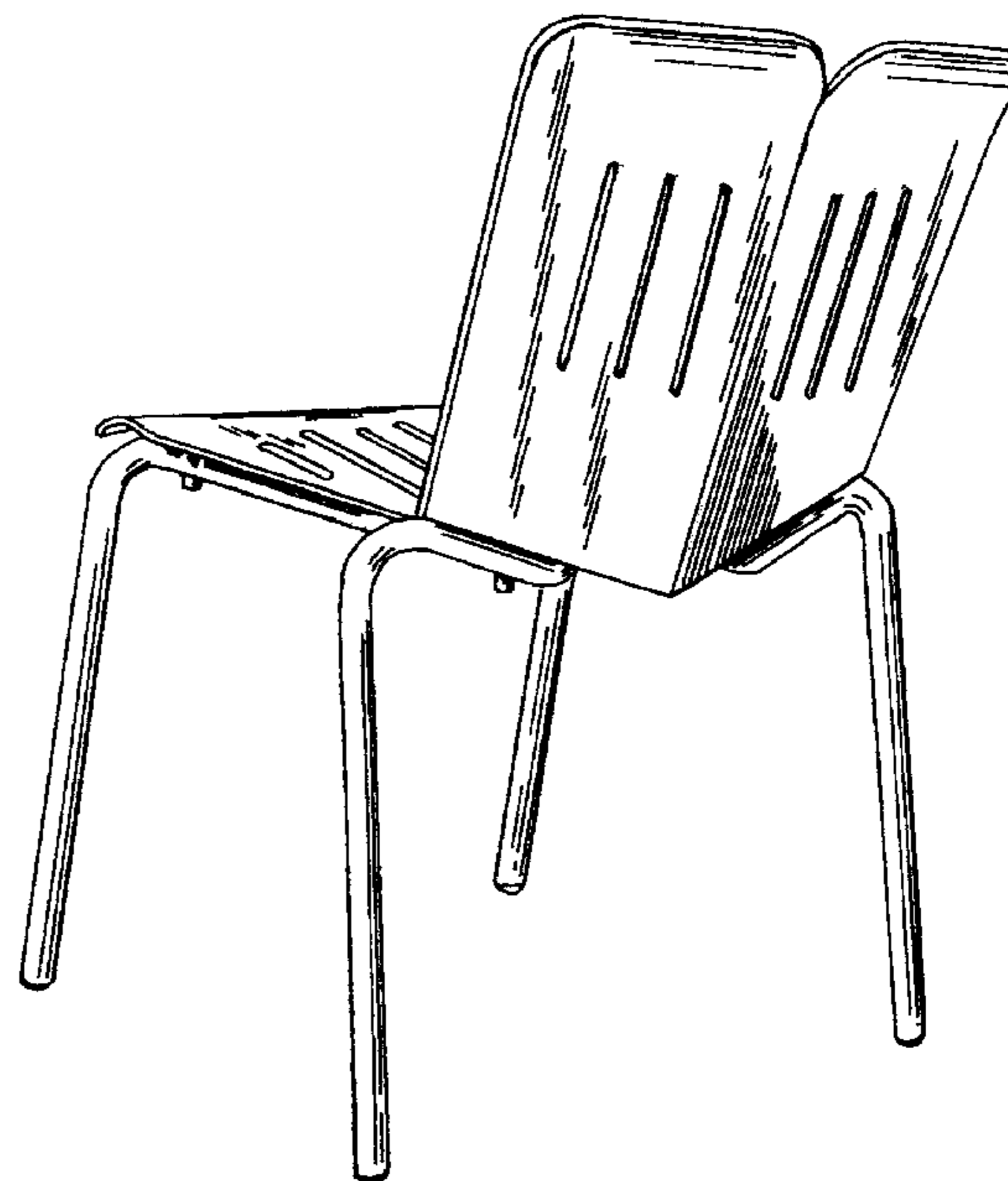
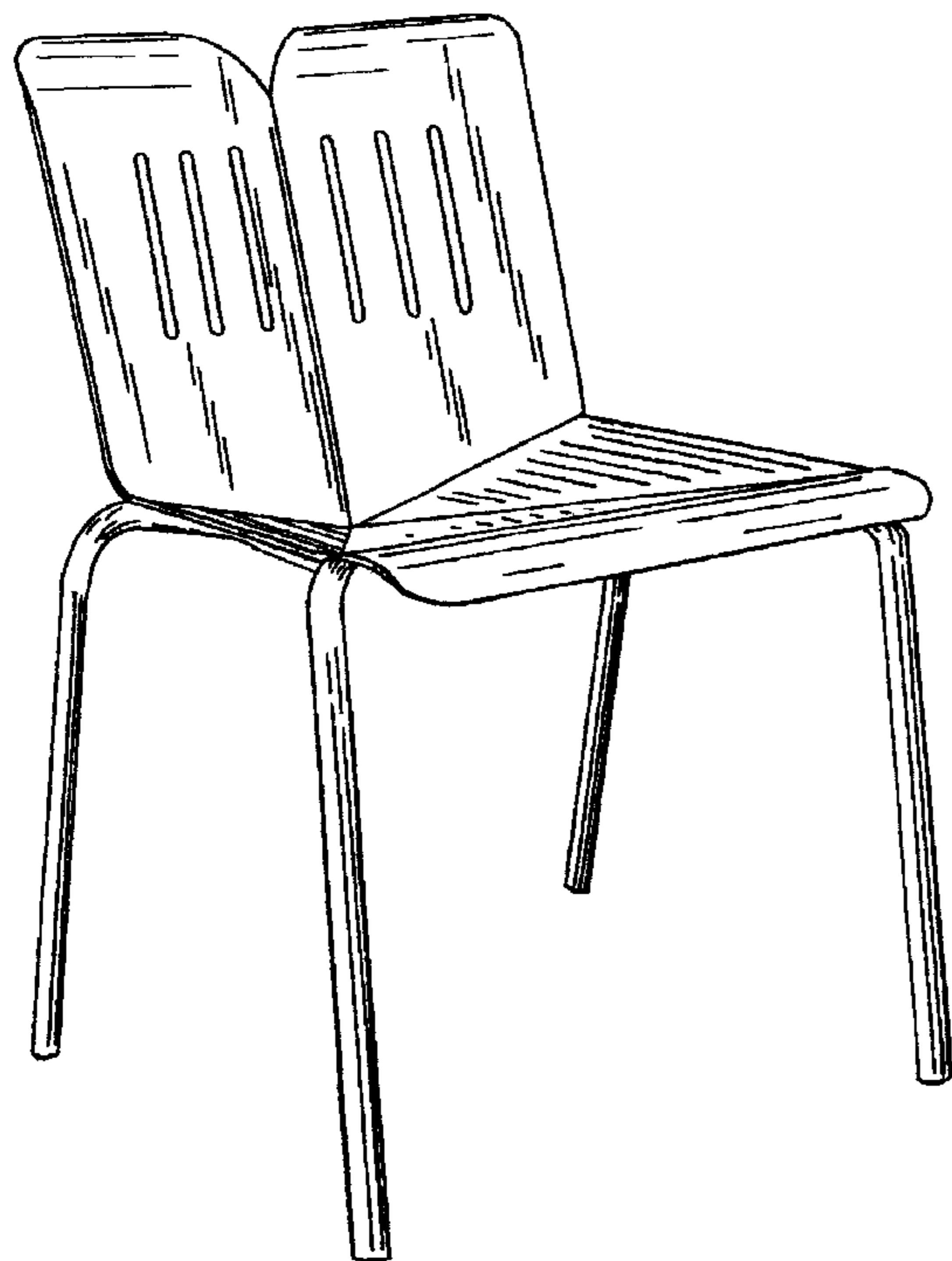

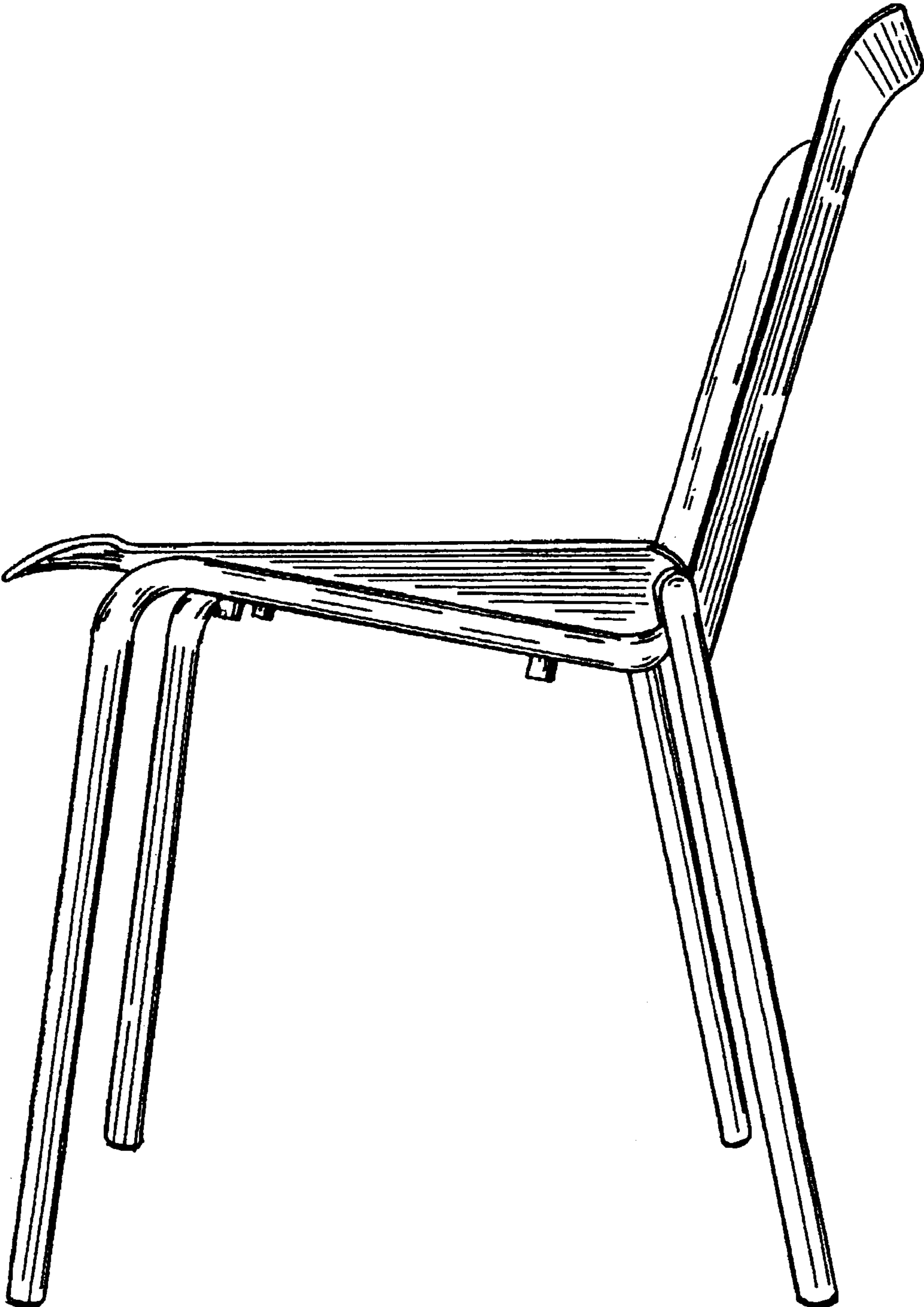

FIG. 1

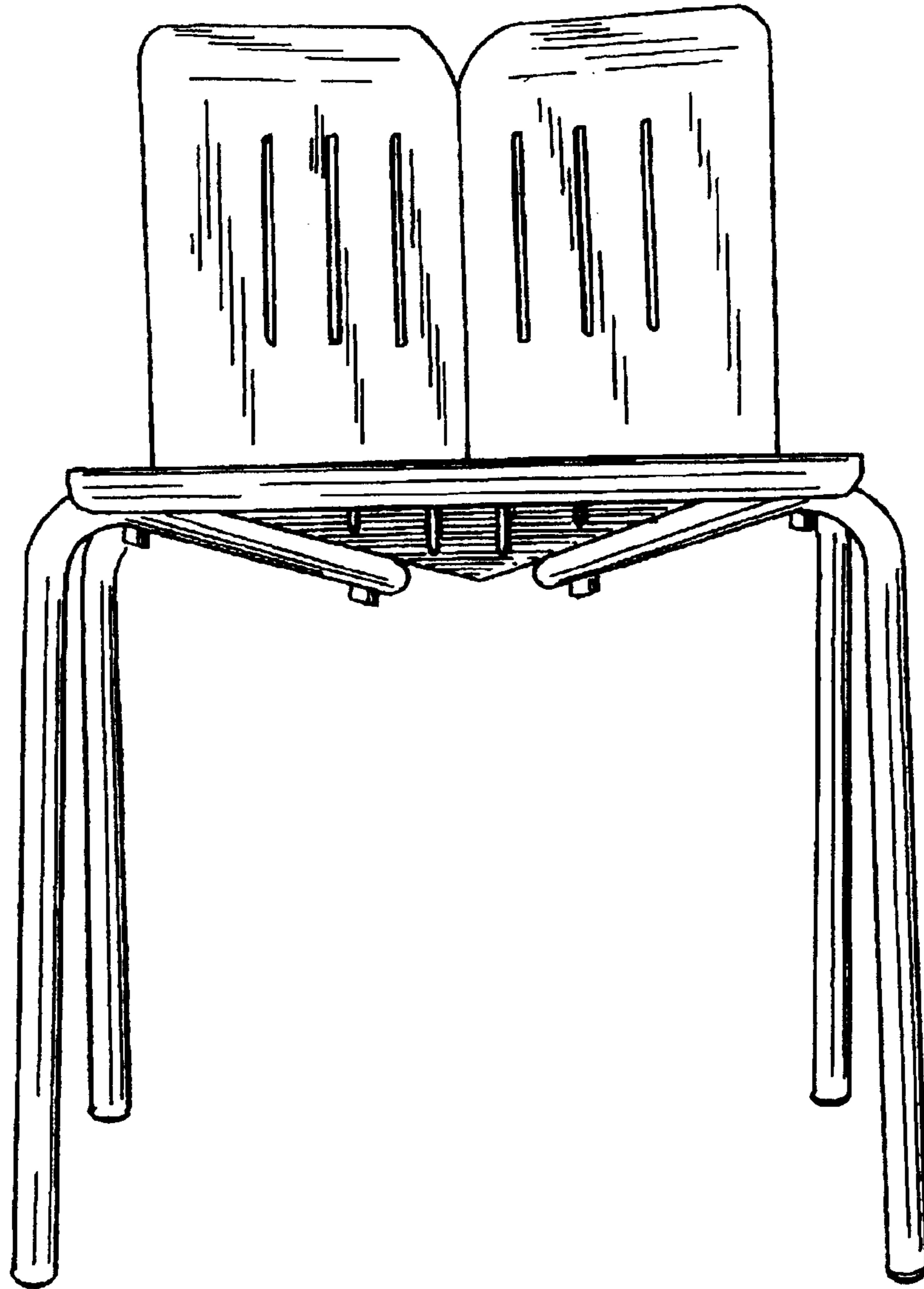

FIG. 2

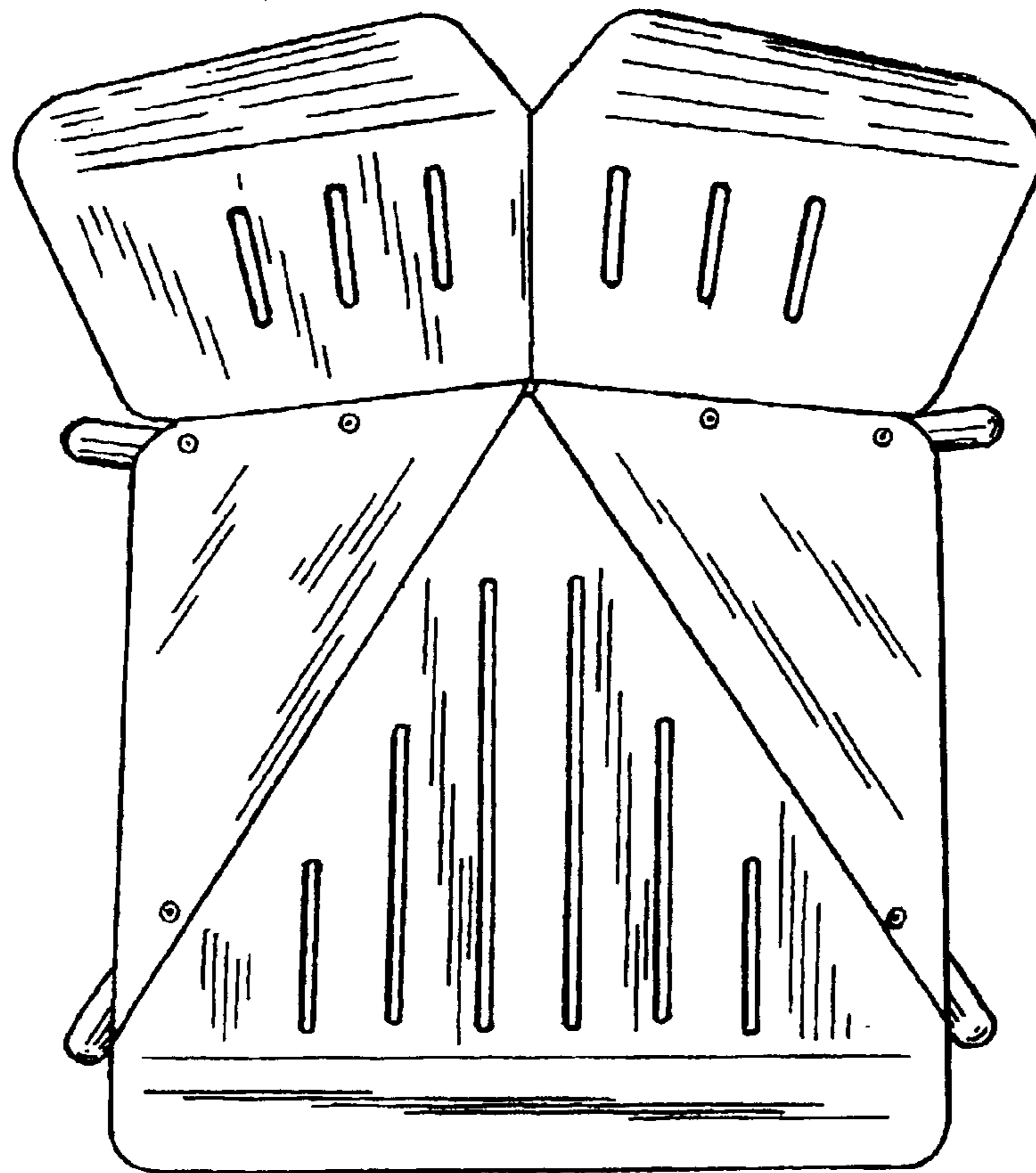

FIG. 3

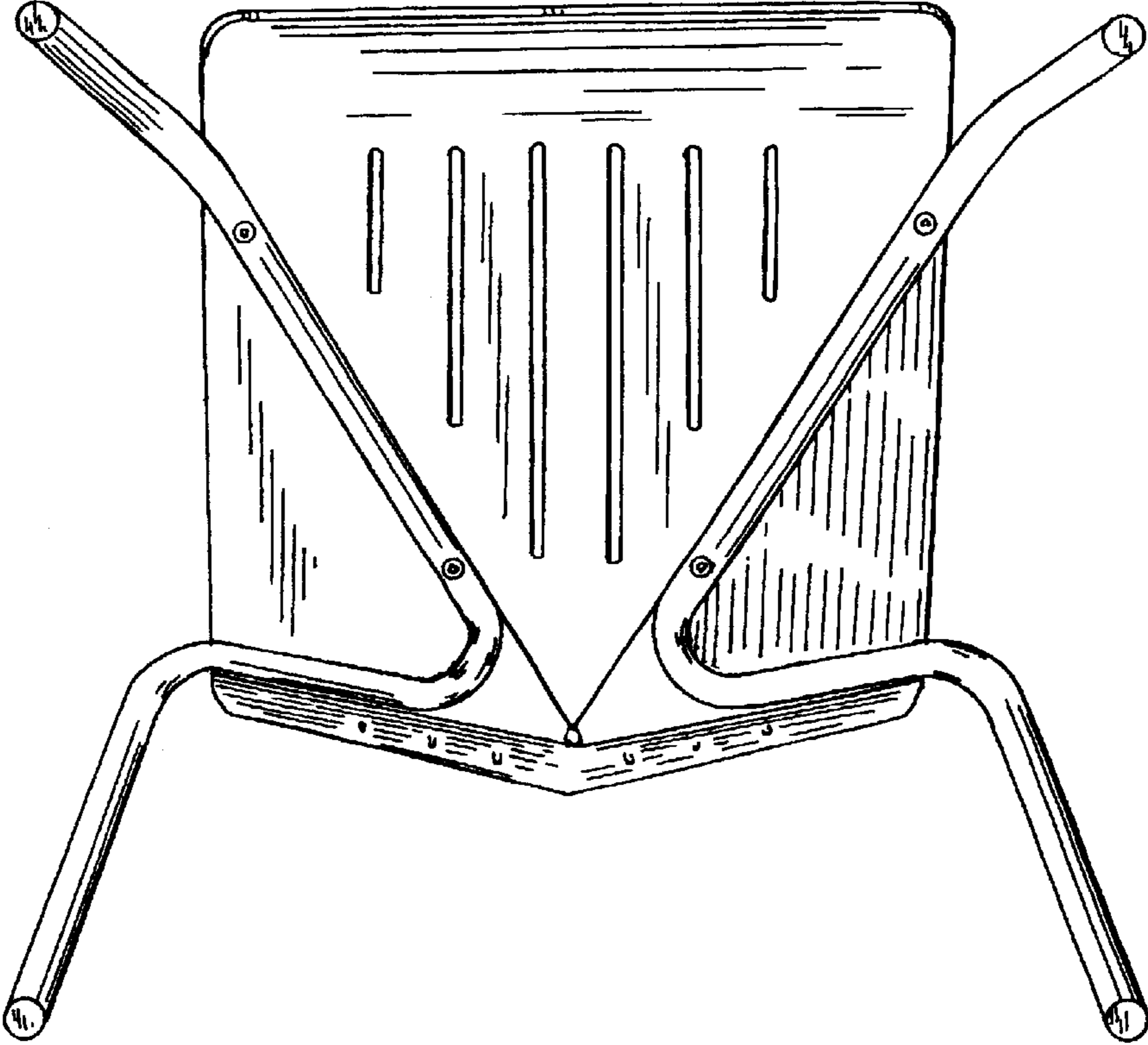

FIG. 4

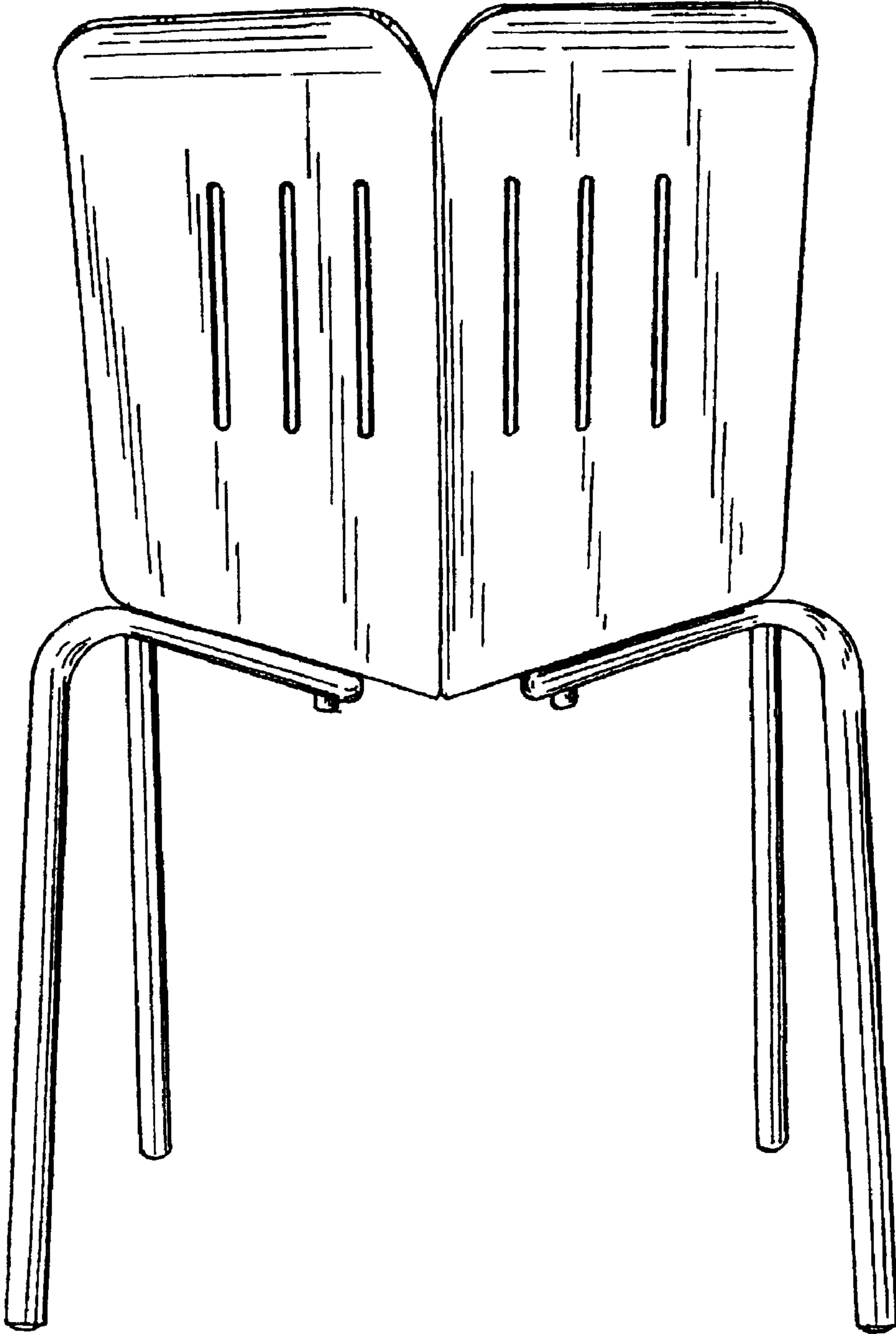

FIG. 5

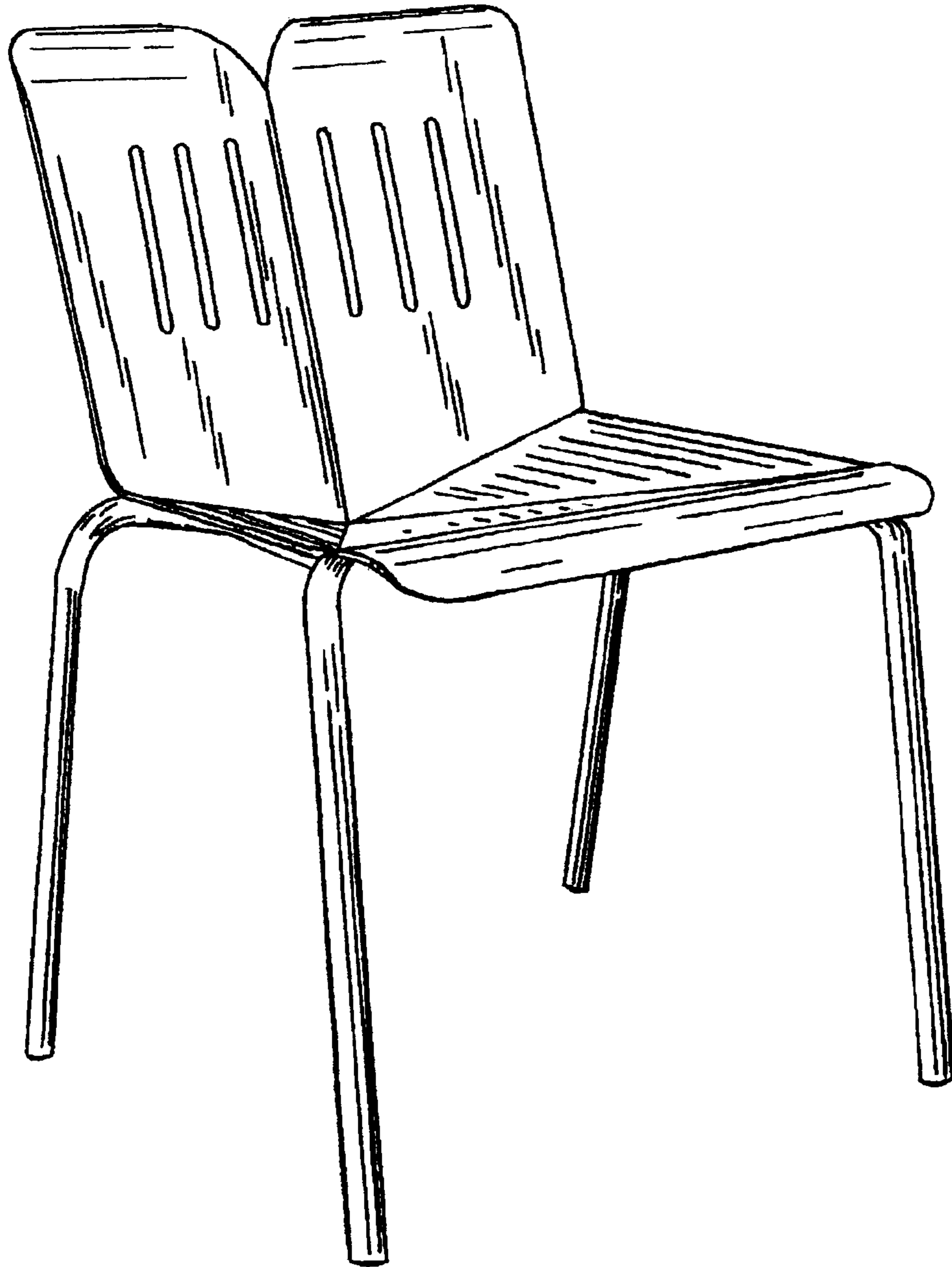

FIG. 6

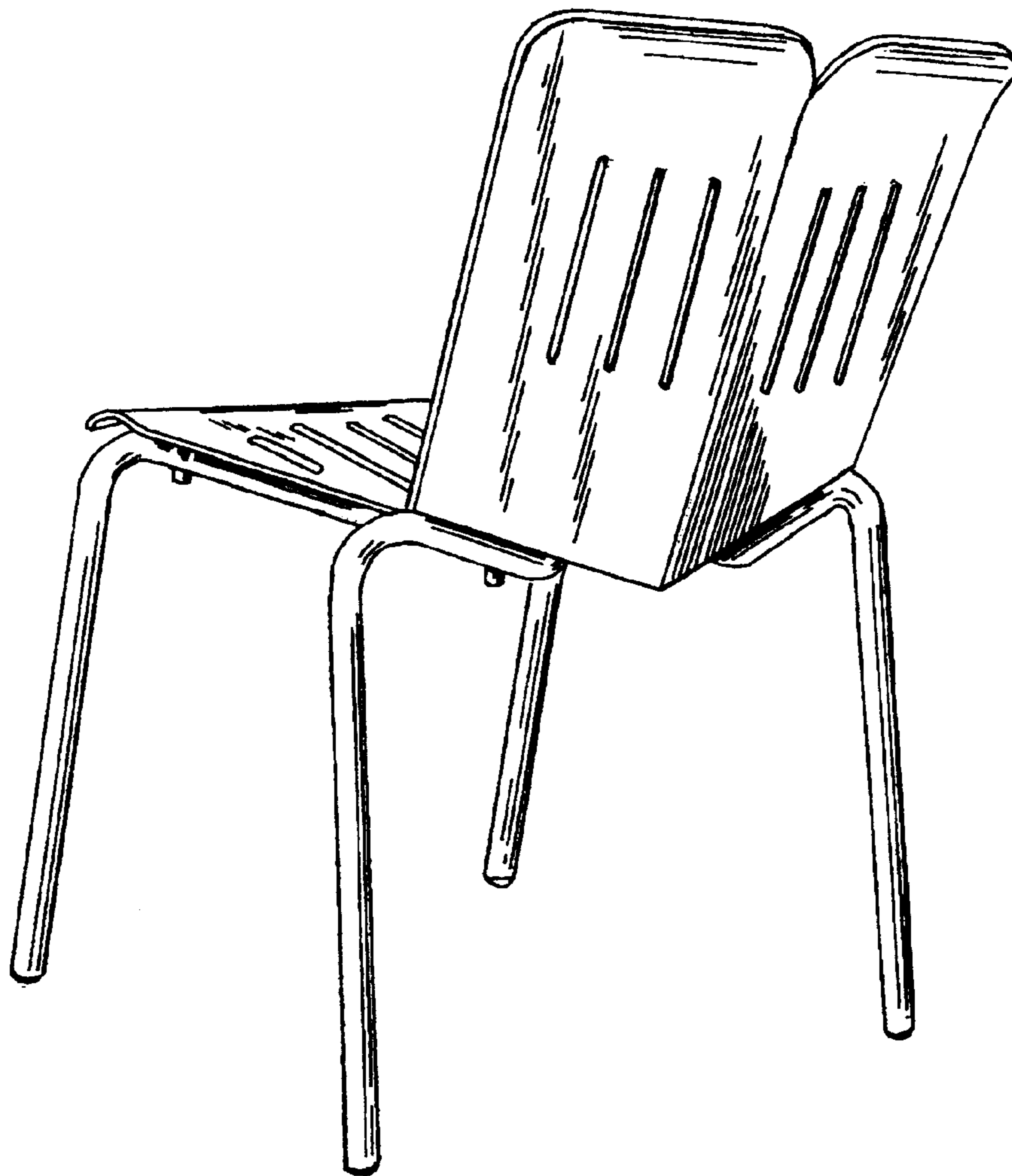

FIG. 7