



US00D511404S

(12) **United States Design Patent**
O'Dell et al.

(10) **Patent No.:** **US D511,404 S**

(45) **Date of Patent:** **** Nov. 8, 2005**

(54) **SUPPORT BASE**

D354,606 S * 1/1995 Pigott et al. D34/38
5,749,555 A * 5/1998 Albrecht 248/346.01

(76) Inventors: **Graham O'Dell**, 18 Woodhouse Rd.
East Fremantle, Perth WA 6158 (AU);
Marisa Kristine O'Dell, 18 Woodhouse
Rd. East Fremantle, Perth WA 6158
(AU)

* cited by examiner

Primary Examiner—Cynthia E. Ramirez

(**) **Term:** **14 Years**

(57) **CLAIM**

(21) **Appl. No.:** **29/192,327**

The ornamental design for a support base, as shown and described.

(22) **Filed:** **Oct. 23, 2003**

DESCRIPTION

(30) **Foreign Application Priority Data**

Jul. 8, 2003 (AU) 2327/2003

(51) **LOC (8) Cl.** **09-08**

(52) **U.S. Cl.** **D34/38**

(58) **Field of Search** D34/38; 108/51.11,
108/51.3, 52.1, 53.1, 53.3, 53.5, 55.1, 56.1,
57.3; D25/113, 118

FIG. 1 is an upper perspective view;
FIG. 2 is a lower perspective view;
FIG. 3 is a top plan view;
FIG. 4 is a bottom plan view;
FIG. 5 is an end view; and,
FIG. 6 is a side view.

(56) **References Cited**

U.S. PATENT DOCUMENTS

5,307,931 A * 5/1994 Gillispie et al. 206/386

1 Claim, 5 Drawing Sheets

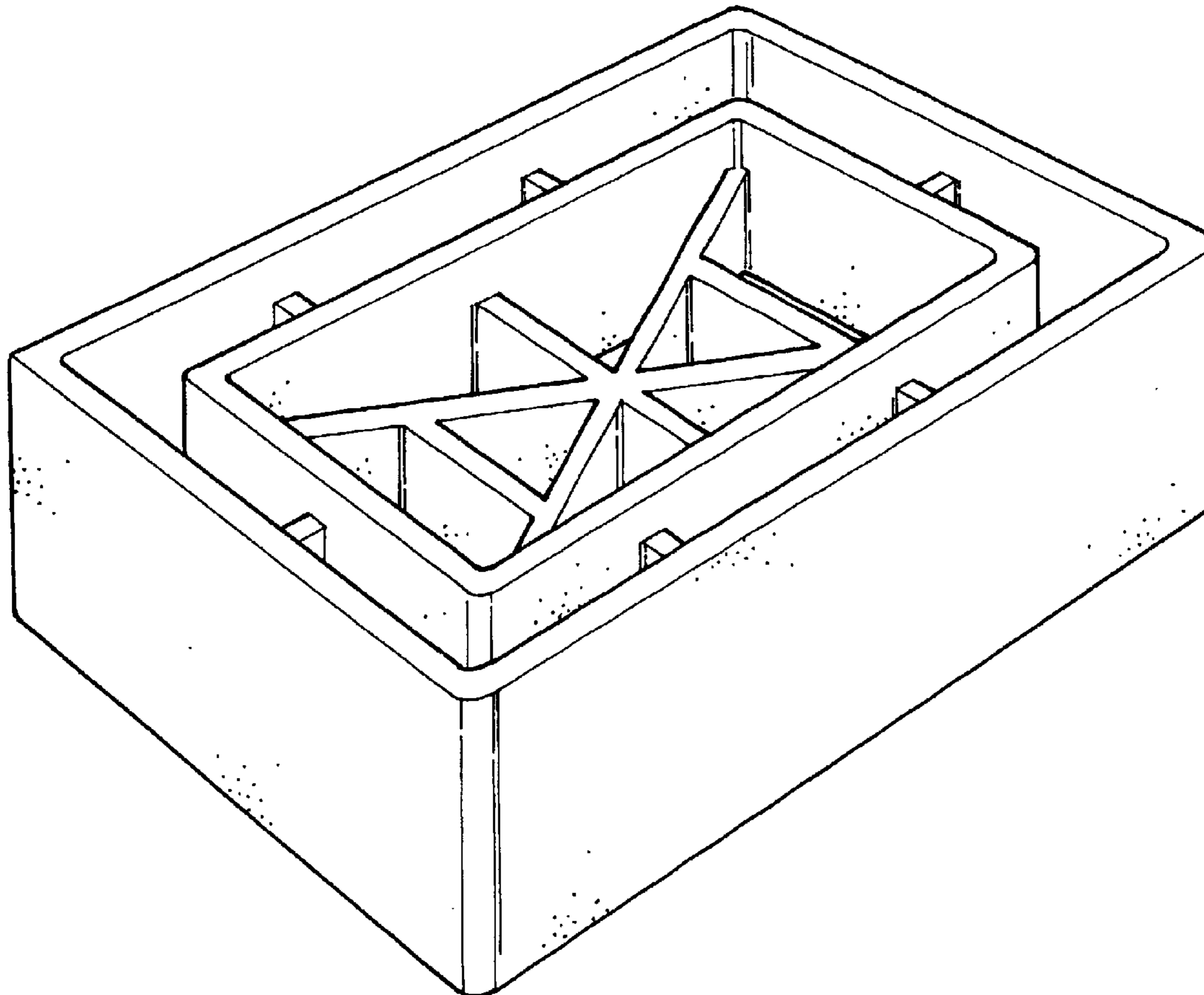

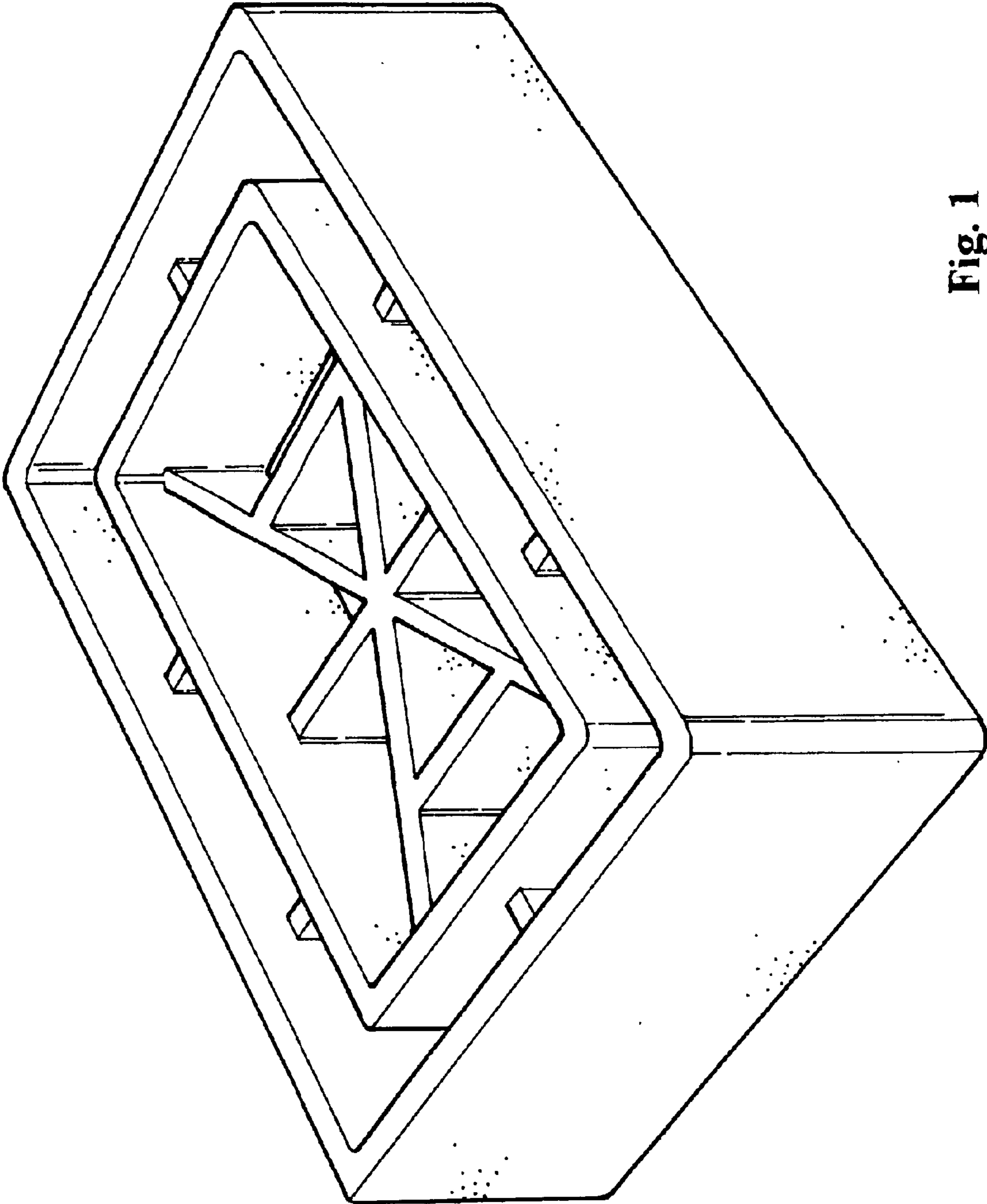

Fig. 1

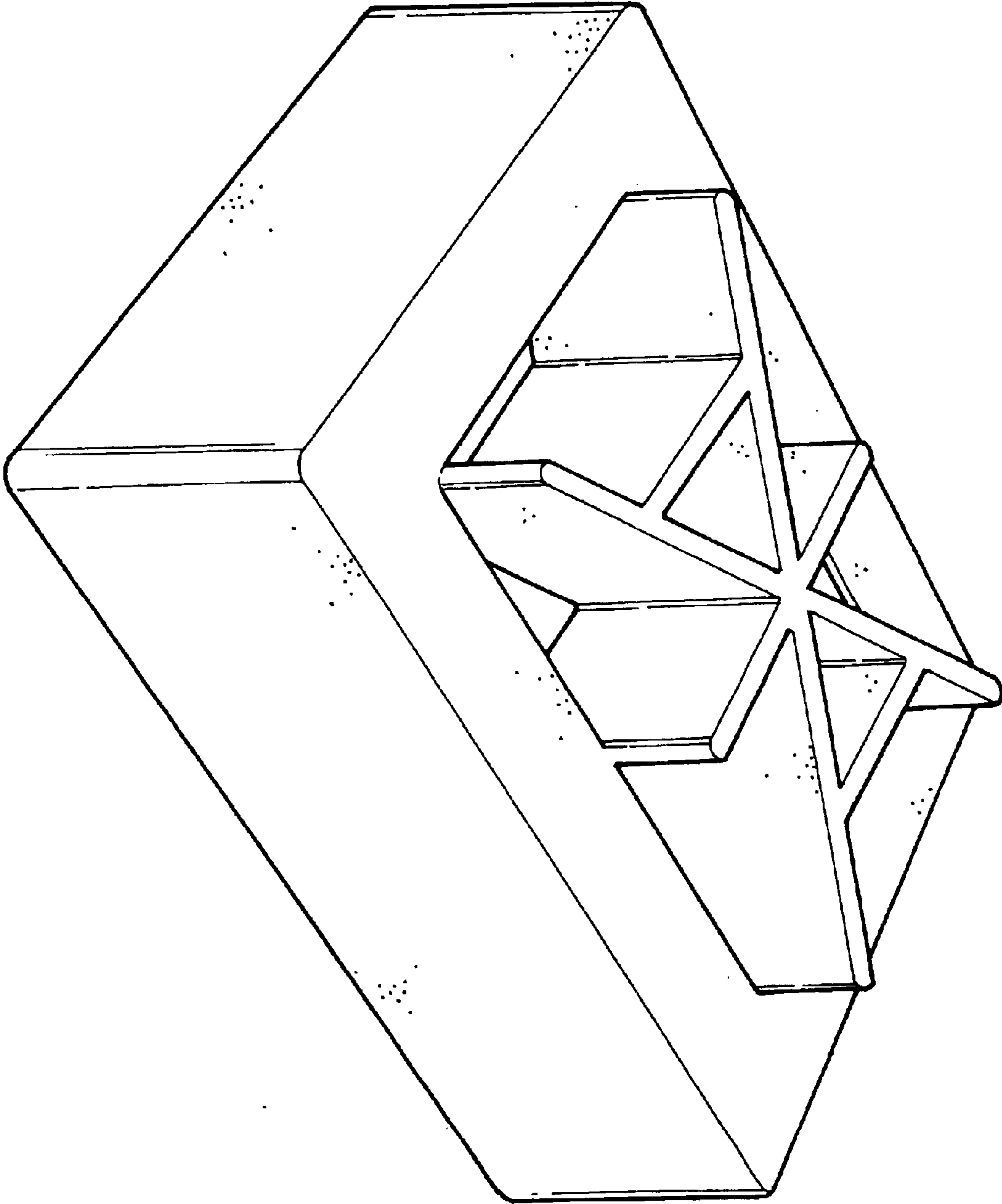

Fig. 2

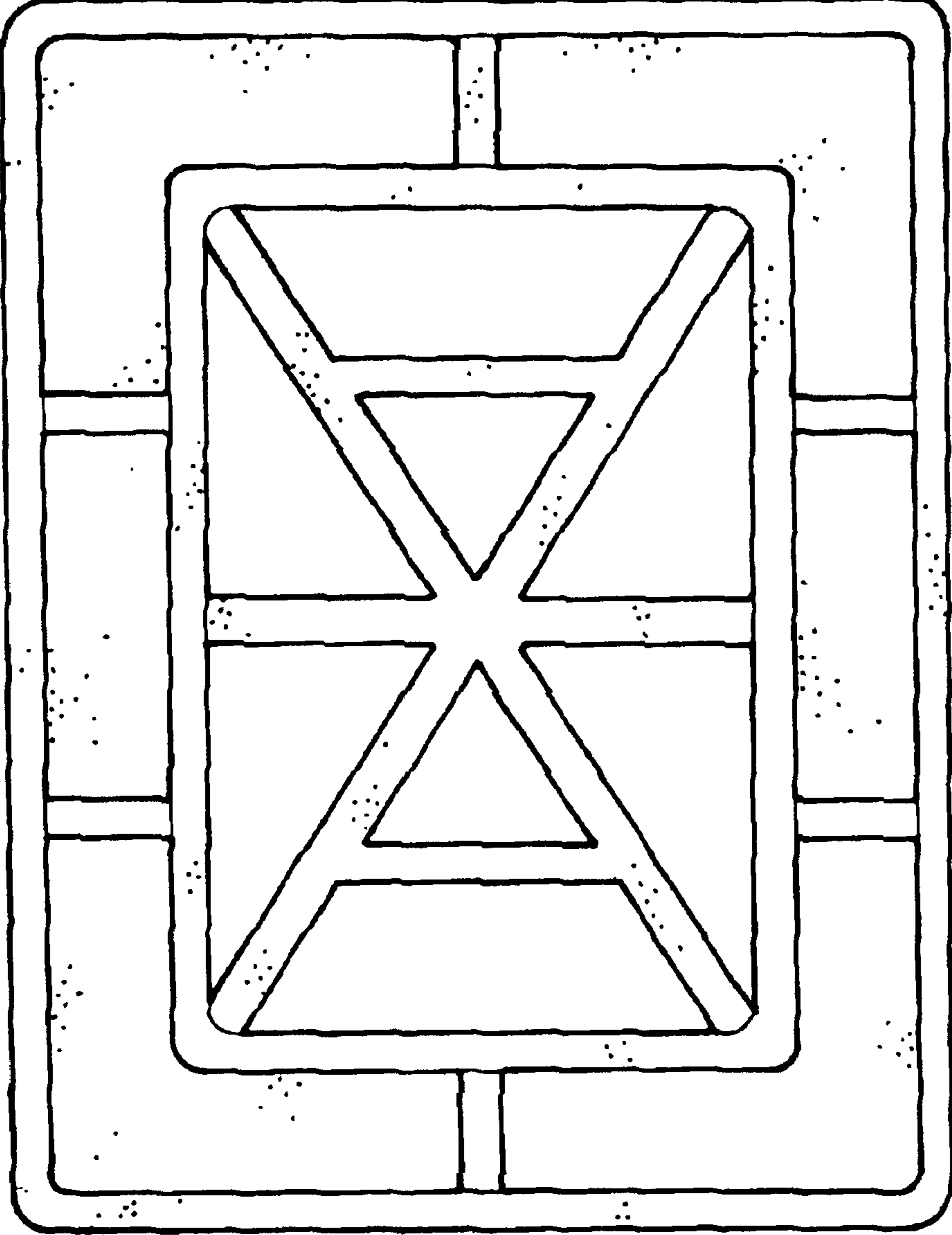

Fig. 3

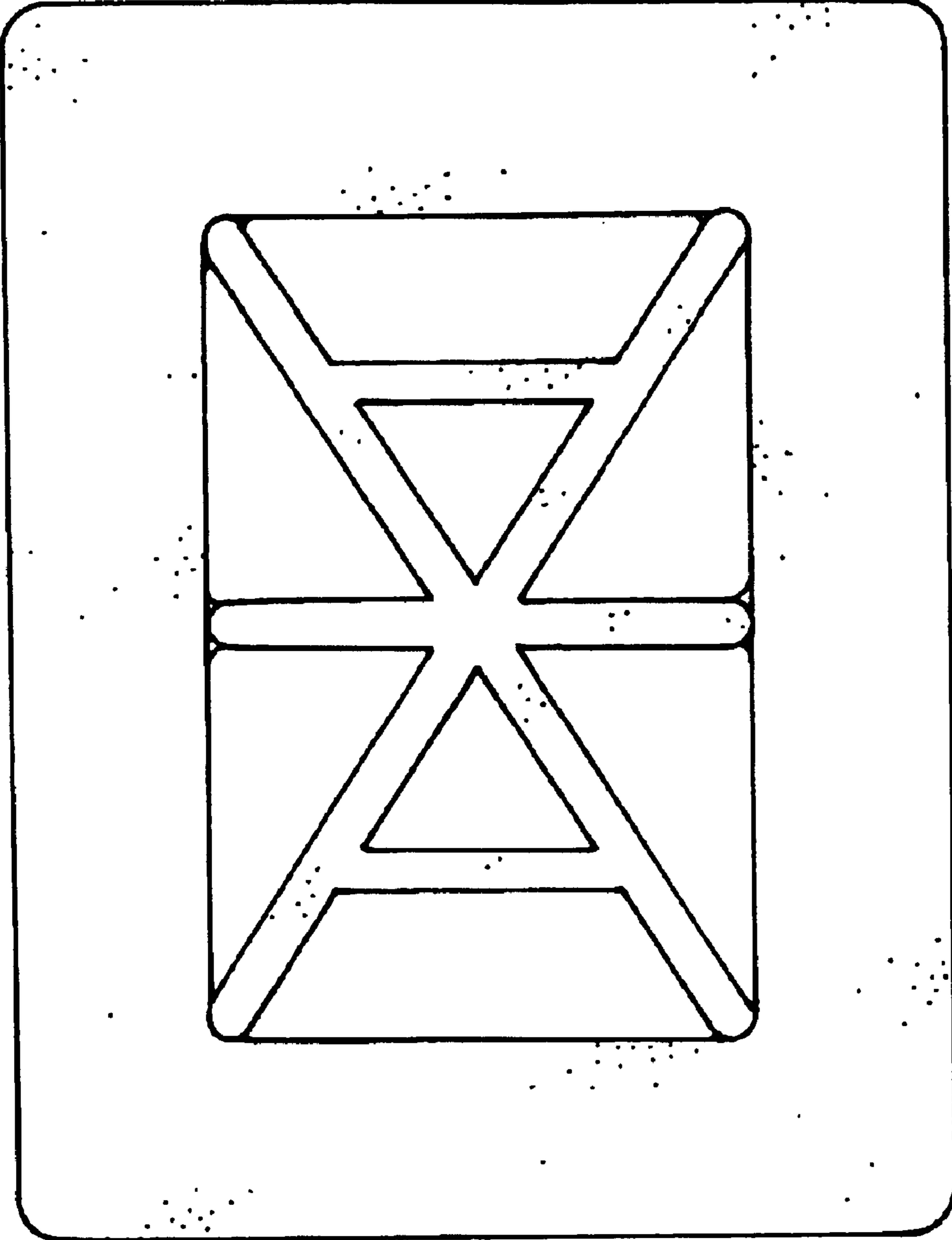

Fig. 4

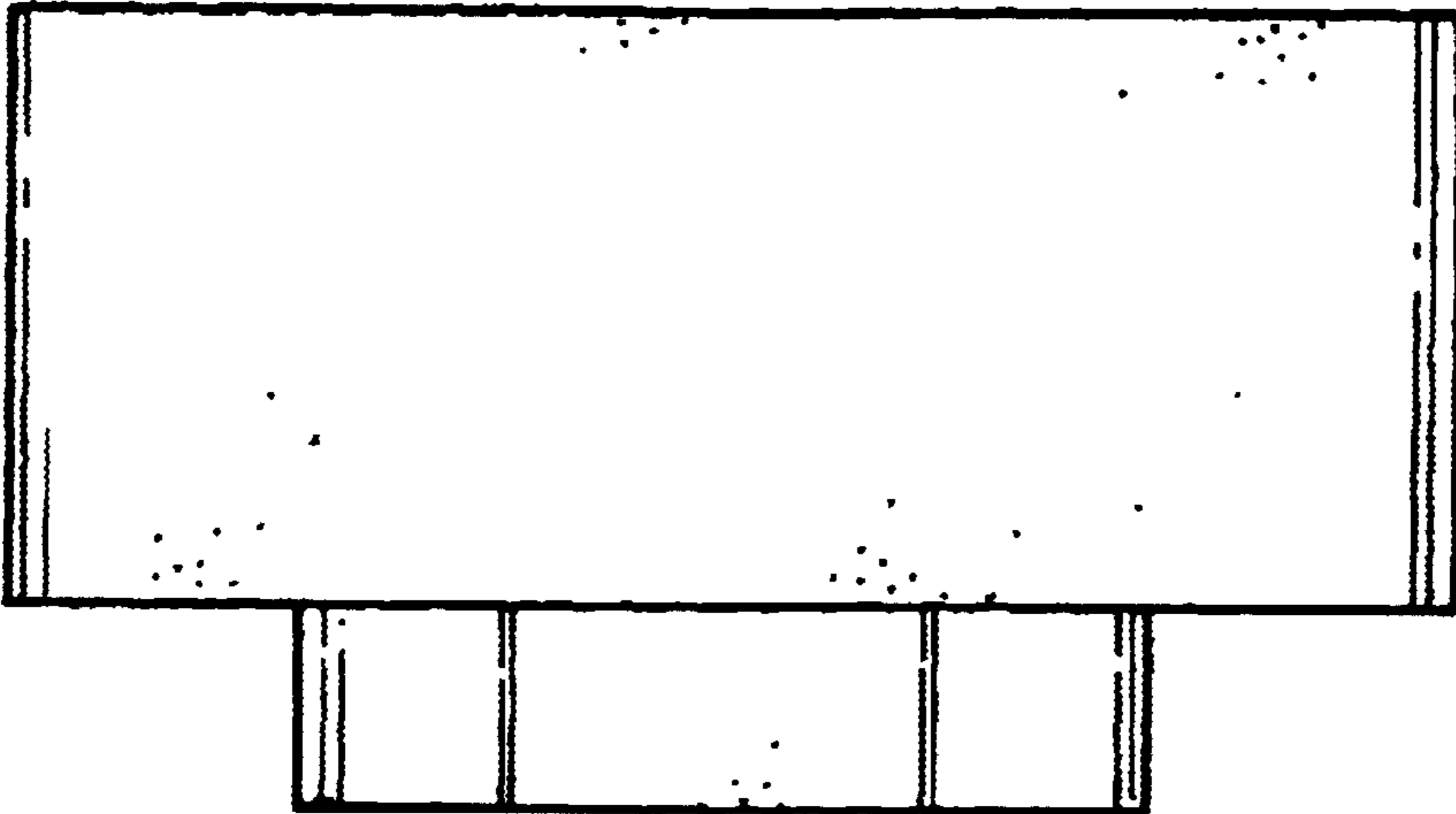

Fig. 5

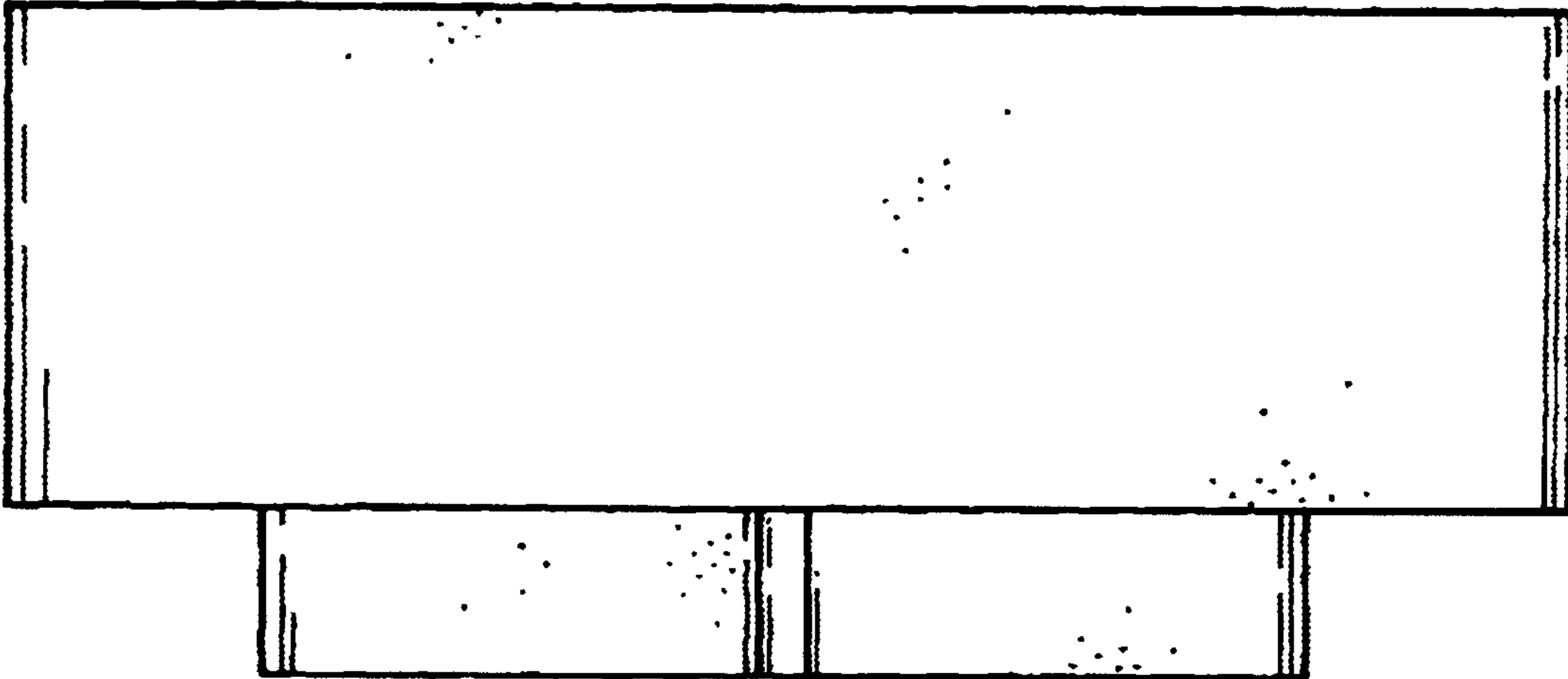

Fig. 6