



US00D511380S

(12) **United States Design Patent**
Marshall

(10) **Patent No.:** **US D511,380 S**

(45) **Date of Patent:** **** Nov. 8, 2005**

(54) **FAN BLADE FOR A CEILING FAN**

(76) **Inventor:** **John C. Marshall**, 6249 Thibodeaux Rd., Greenwell Springs, LA (US) 70739

(**) **Term:** **14 Years**

(21) **Appl. No.:** **29/212,005**

(22) **Filed:** **Aug. 26, 2004**

(51) **LOC (8) Cl.** **23-04**

(52) **U.S. Cl.** **D23/413**

(58) **Field of Search** D23/413, 377,
D23/379, 385, 411; 416/5, 210 R

(56) **References Cited**

U.S. PATENT DOCUMENTS

D383,858 S * 9/1997 Morris D25/164

D454,636 S * 3/2002 Lantz D23/413

* cited by examiner

Primary Examiner—Lisa Lichtenstein

(74) *Attorney, Agent, or Firm*—Berenato, White & Stavish, LLC

(57) **CLAIM**

I claim, the ornamental design for a fan blade for a ceiling fan, as shown and described.

DESCRIPTION

FIG. 1 is a plan view of a fan blade for a ceiling fan;
FIG. 2 is an enlarged perspective view of a fan blade for a ceiling fan;
FIG. 3 is an enlarged top plan view;
FIG. 4 is an enlarged bottom plan view;
FIG. 5 is an enlarged right side elevational view;
FIG. 6 is an enlarged left side elevational view;
FIG. 7 is an enlarged front elevational view; and,
FIG. 8 is an enlarged rear elevational view.

The broken line showing is for illustrative purposes only and forms no part of the claimed invention.

1 Claim, 4 Drawing Sheets

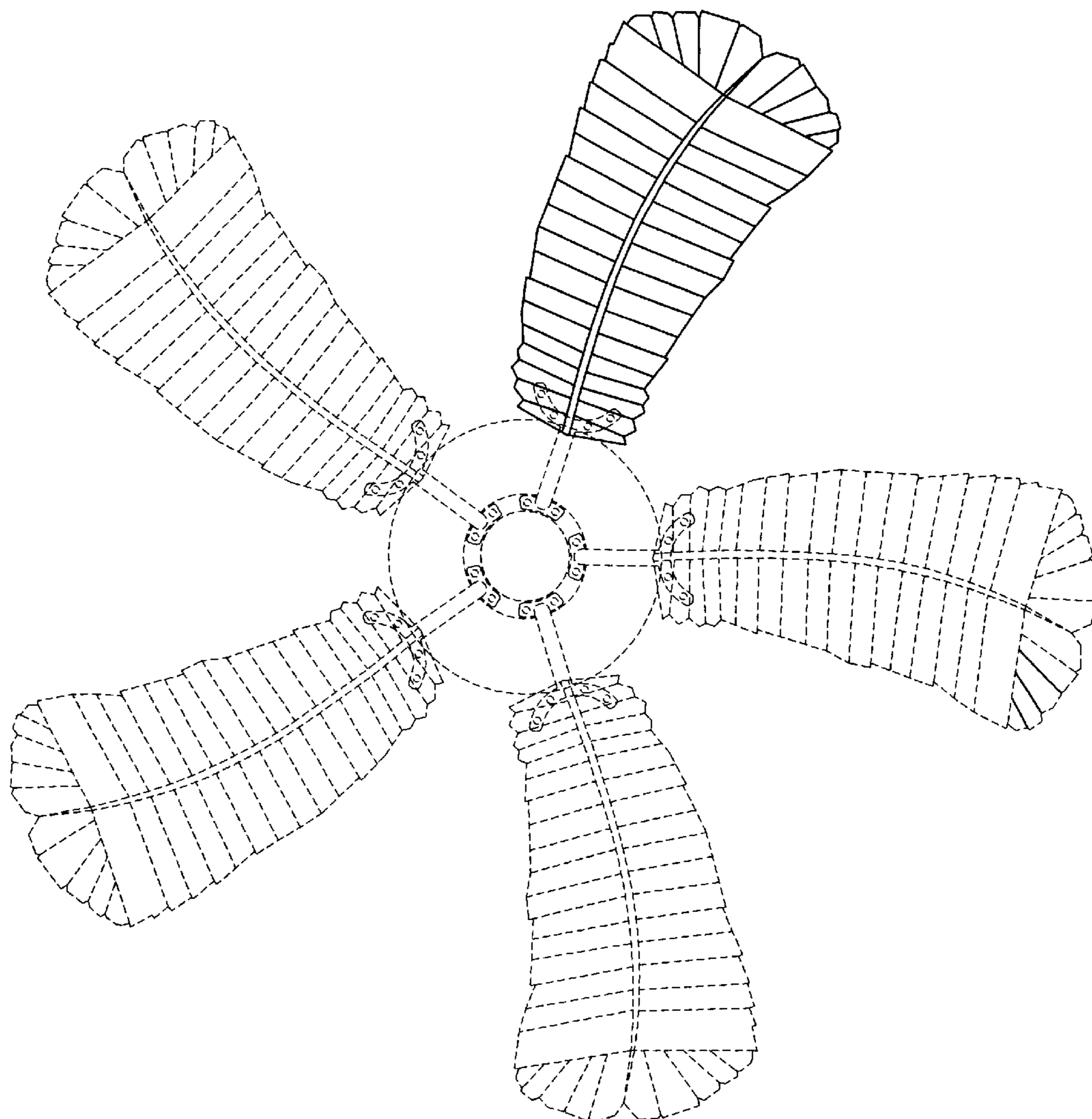

Fig. 1

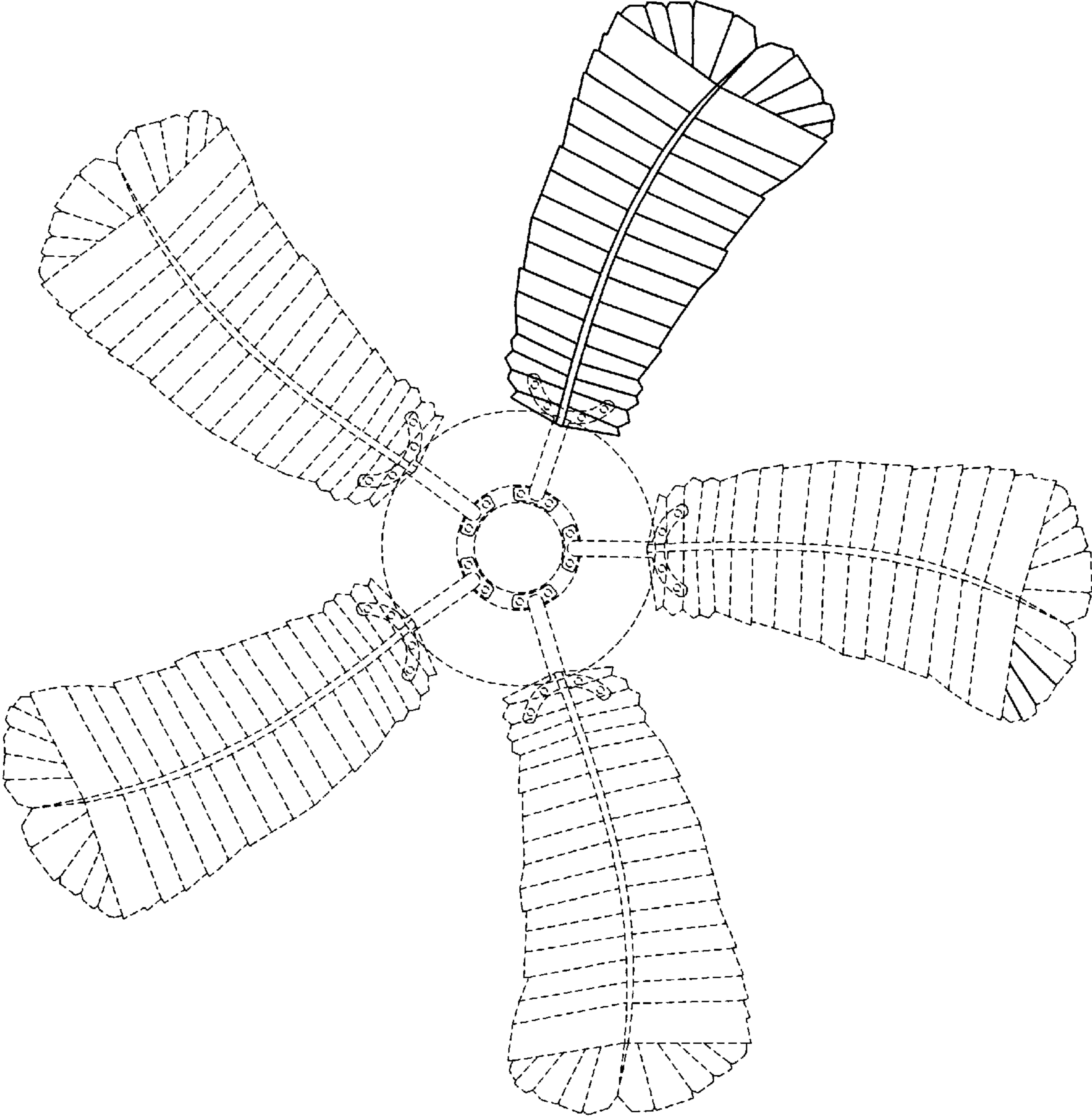

Fig. 2

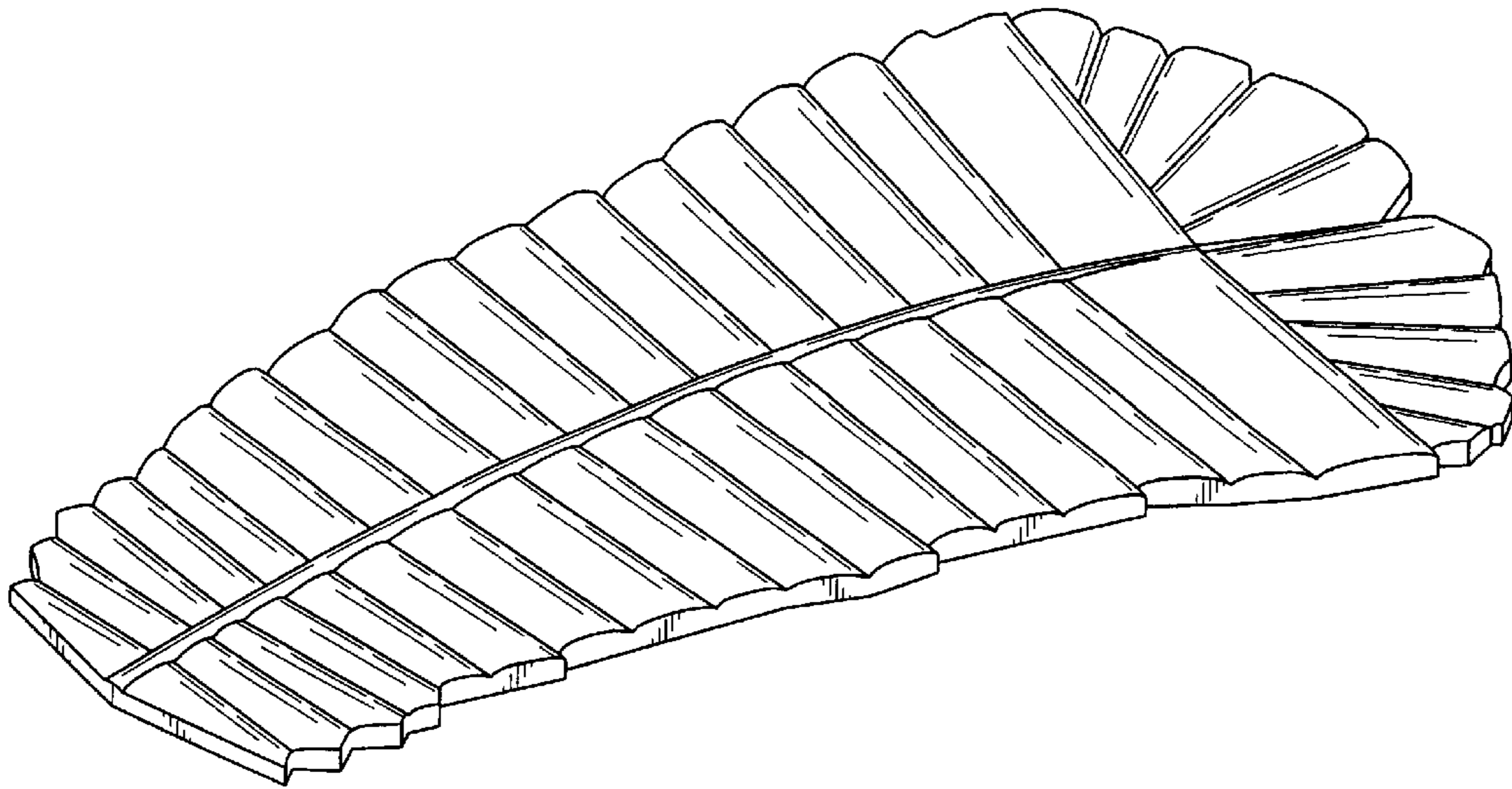

Fig. 3

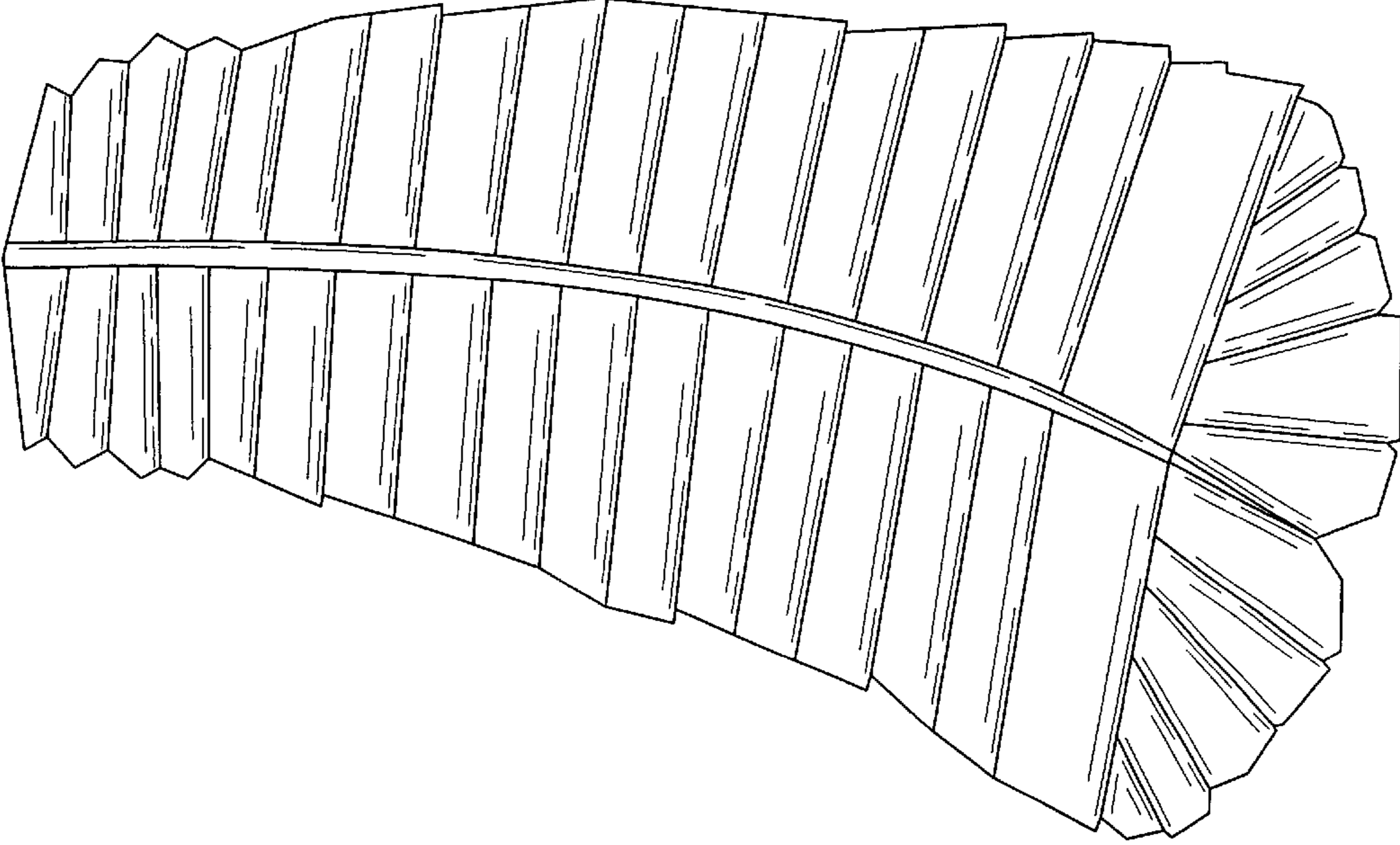

Fig. 4

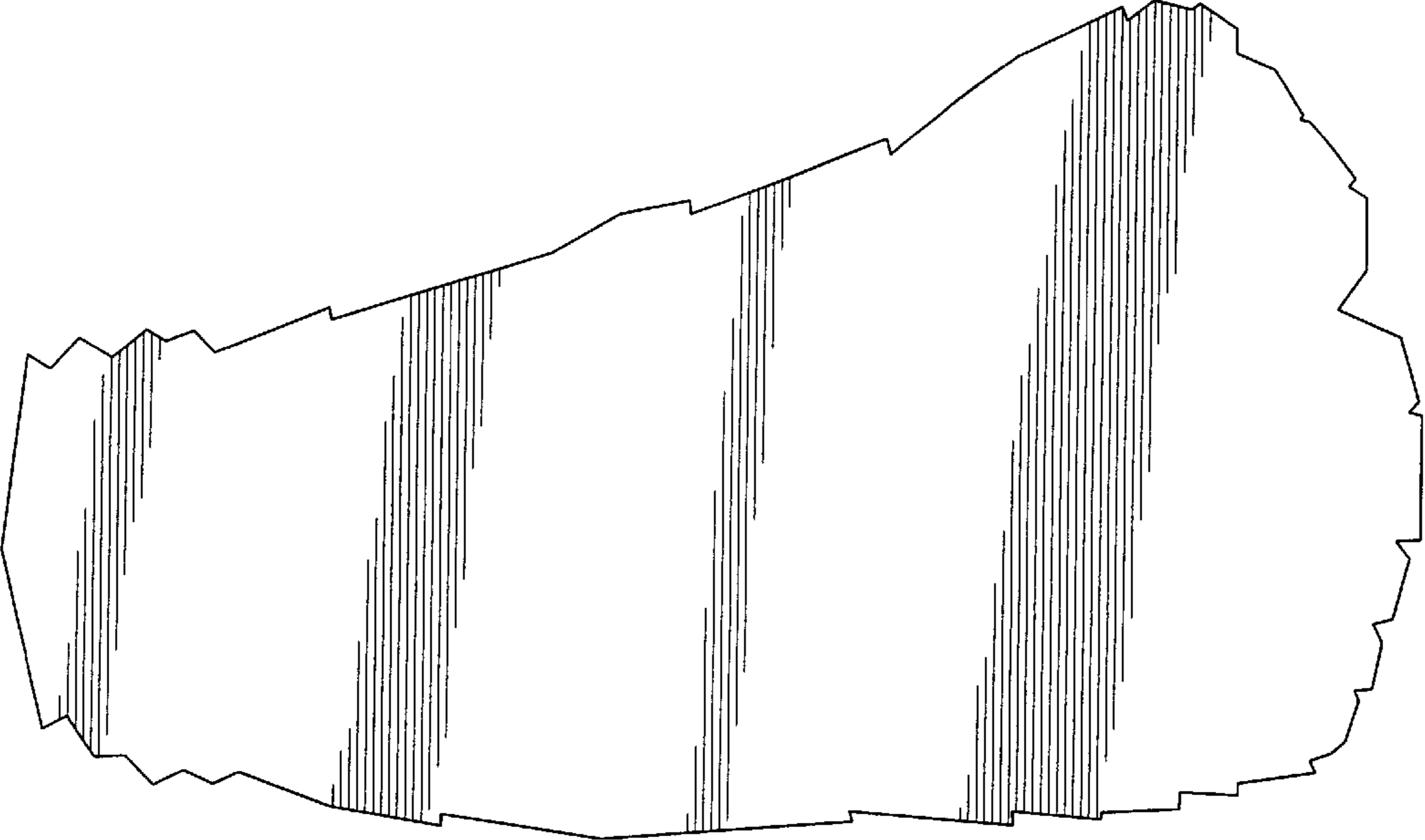

Fig. 5

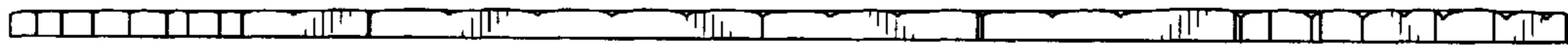

Fig. 6

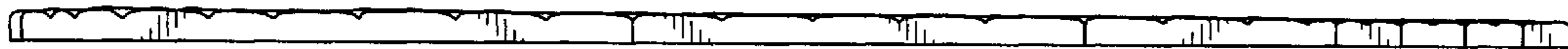

Fig. 7

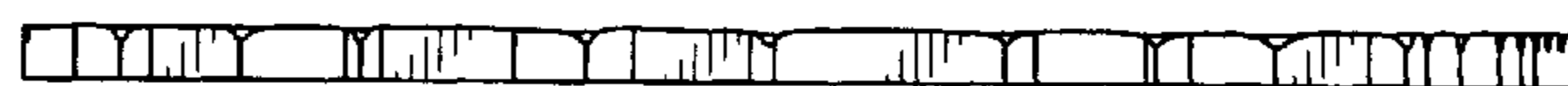

Fig. 8

