



US00D511368S

(12) **United States Design Patent** (10) **Patent No.:** **US D511,368 S**
Becker (45) **Date of Patent:** **** Nov. 8, 2005**

(54) **FISHING JIG LURE**

(76) Inventor: **Damion D. Becker**, 22326 Palisade St. NE., East Bethel, MN (US) 55005

(**) Term: **14 Years**

(21) Appl. No.: **29/202,723**

(22) Filed: **Apr. 3, 2004**

(51) **LOC (8) Cl.** **22-05**

(52) **U.S. Cl.** **D22/144**

(58) **Field of Search** D22/144, 125-133;
43/42.37, 42.41, 42.35, 42.2, 42.6, 42.25,
42.13, 42.19, 17.6, 42.34, 42.31

(56) **References Cited**

U.S. PATENT DOCUMENTS

3,541,718	A	*	11/1970	Norman	43/42.35
4,972,623	A	*	11/1990	Delricco	43/17.6
D333,860	S	*	3/1993	Barcus	D22/126
5,245,783	A		9/1993	Cumiskey	43/42.37
5,649,384	A		7/1997	Manning	43/44.81
D390,623	S		2/1998	Phelps	D22/126
D405,497	S	*	2/1999	Phelps	D22/126
D425,171	S	*	5/2000	Wicklund	D22/144
6,145,239	A		11/2000	Hirahara et al.	43/42.34
D442,667	S		5/2001	Puccio	D22/126
6,318,016	B1		11/2001	Ellig	43/17.6
D452,291	S		12/2001	Puccio	D22/126
D488,206	S	*	4/2004	Becker	D22/126

* cited by examiner

Primary Examiner—Catherine R. Oliver

(57) **CLAIM**

The ornamental design for a fishing jig lure, as shown and described.

DESCRIPTION

FIG. 1 is a perspective view of a fishing jig lure of my new design;
 FIG. 2 is a top plan view thereof;
 FIG. 3 is a side elevational view thereof, the opposite side elevational view being a mirror image thereof;
 FIG. 4 is a bottom plan view thereof;
 FIG. 5 is a front elevational view thereof;
 FIG. 6 is a rear elevational view thereof;
 FIG. 7 is a sectional view taken along line 7—7 of FIG. 2;
 FIG. 8 is a sectional view taken along line 8—8 of FIG. 2;
 FIG. 9 is a perspective view of a modification of the fishing jig lure of FIG. 1;
 FIG. 10 is a top plan view of FIG. 9;
 FIG. 11 is a side elevational view of FIG. 9, the opposite side being a mirror image thereof;
 FIG. 12 is a bottom plan view of FIG. 9;
 FIG. 13 is a front elevational view of FIG. 9;
 FIG. 14 is a rear elevational view of FIG. 9;
 FIG. 15 is a sectional view taken along line 15—15 of FIG. 10; and,
 FIG. 16 is a sectional view taken long line 16—16 of FIG. 10.

1 Claim, 4 Drawing Sheets

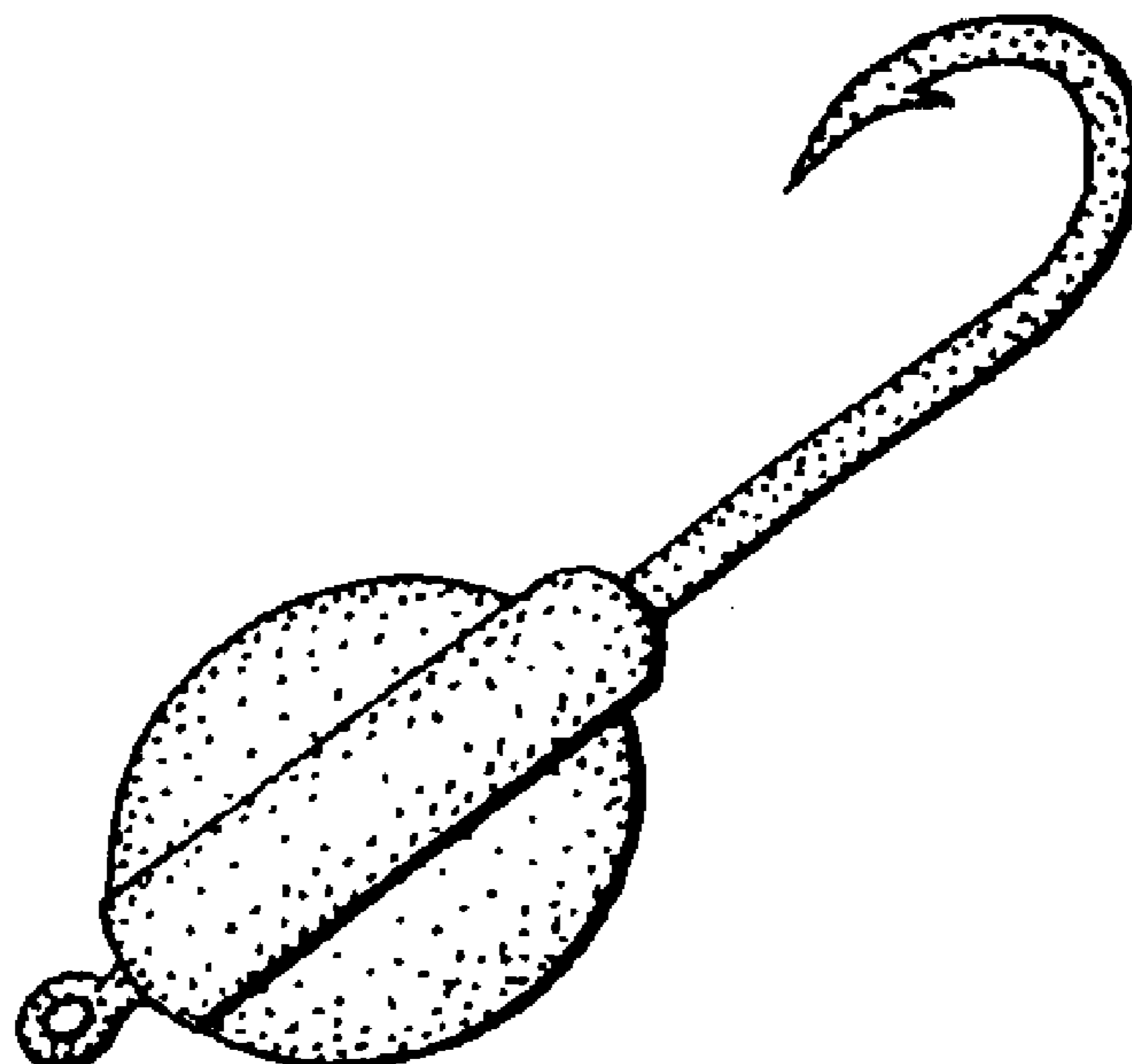

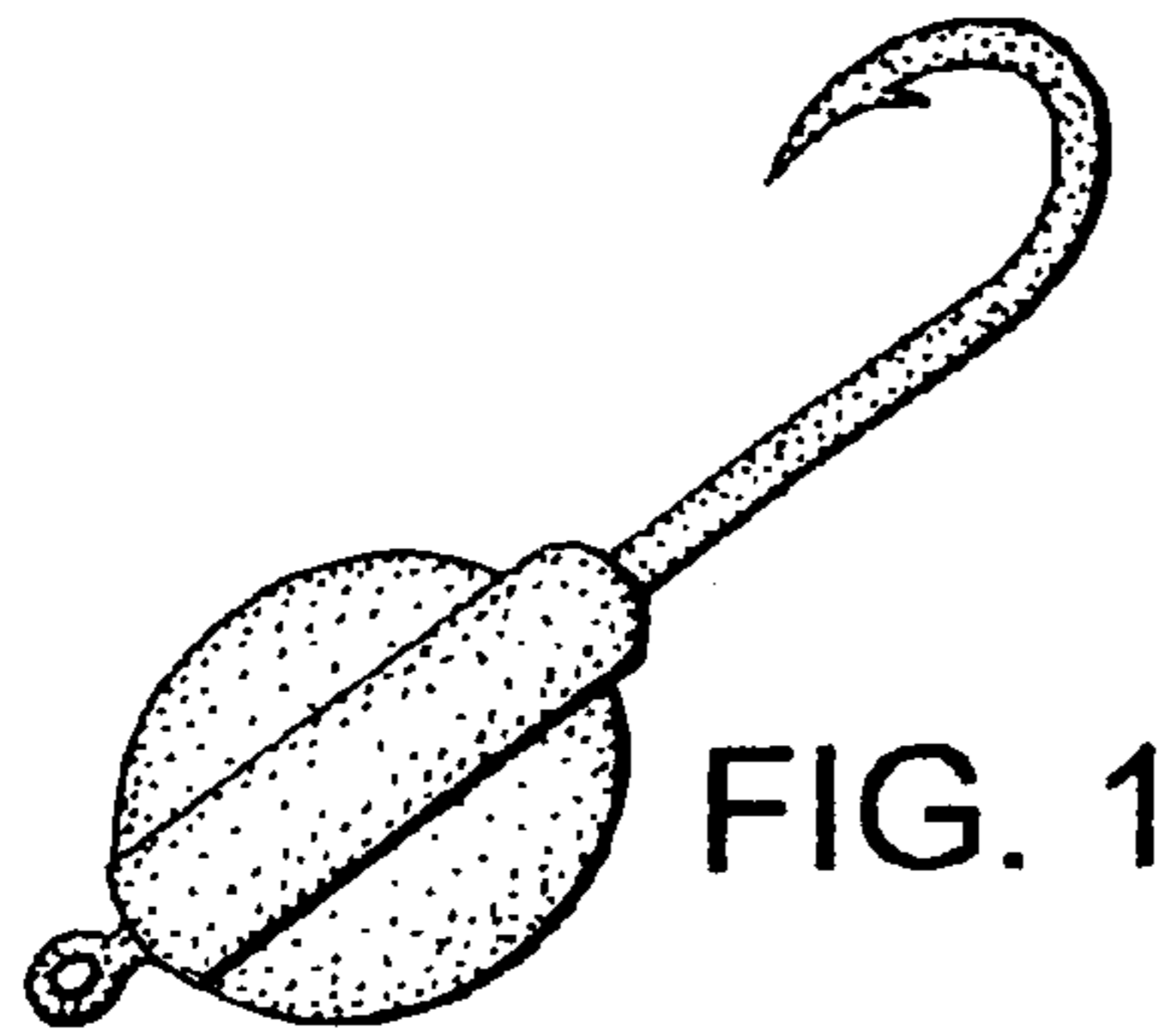

FIG. 1

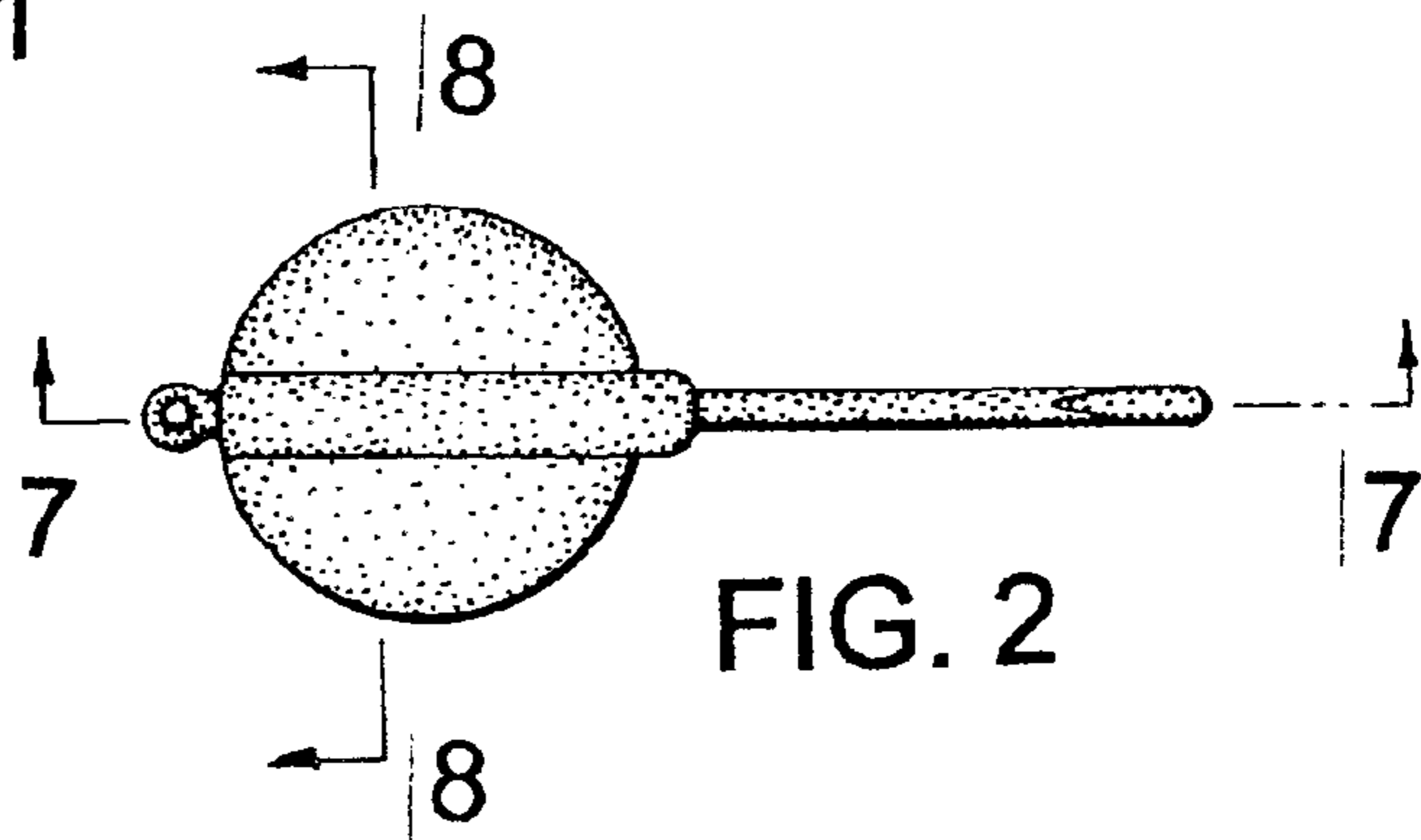

FIG. 2

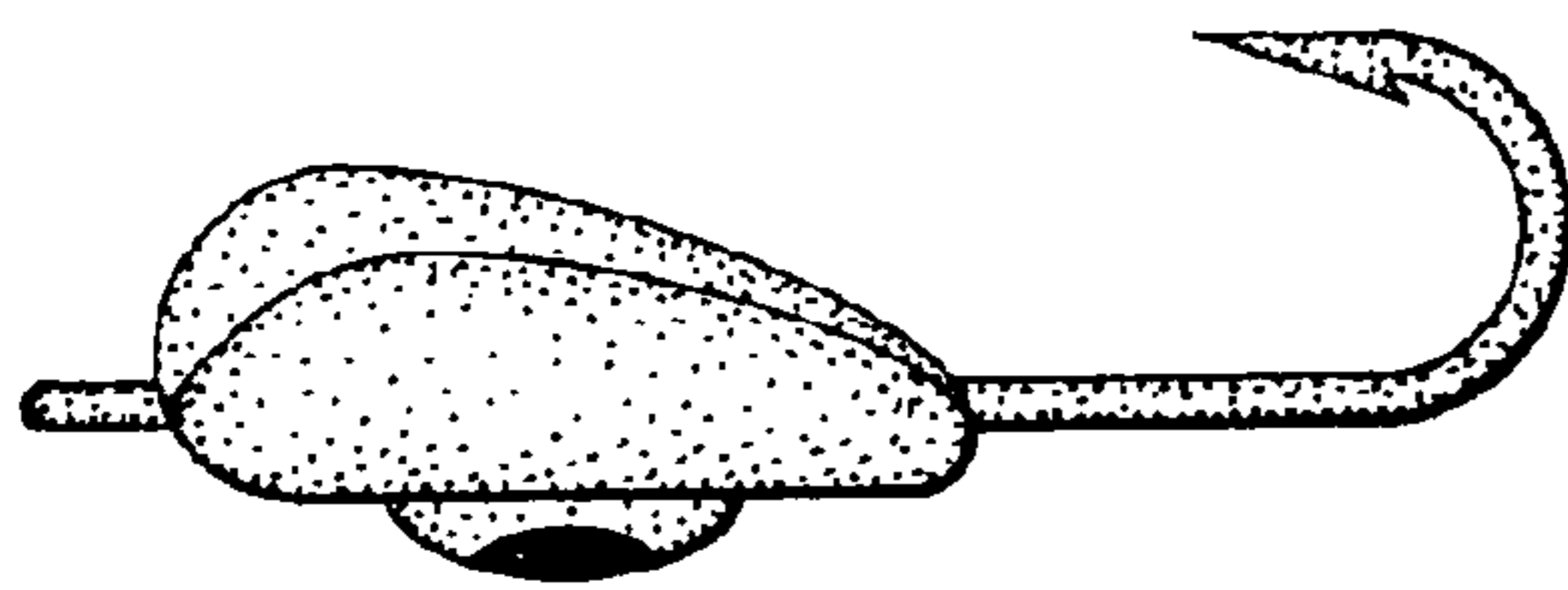

FIG. 3

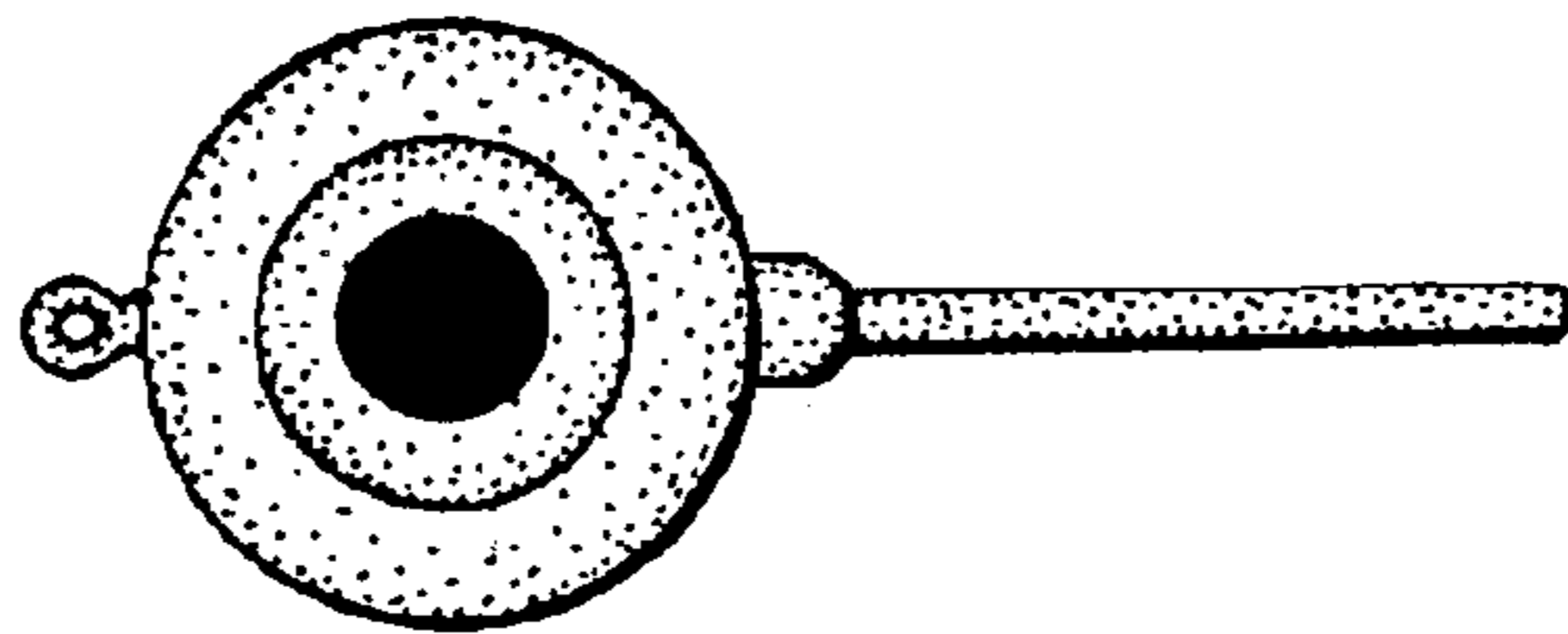

FIG. 4

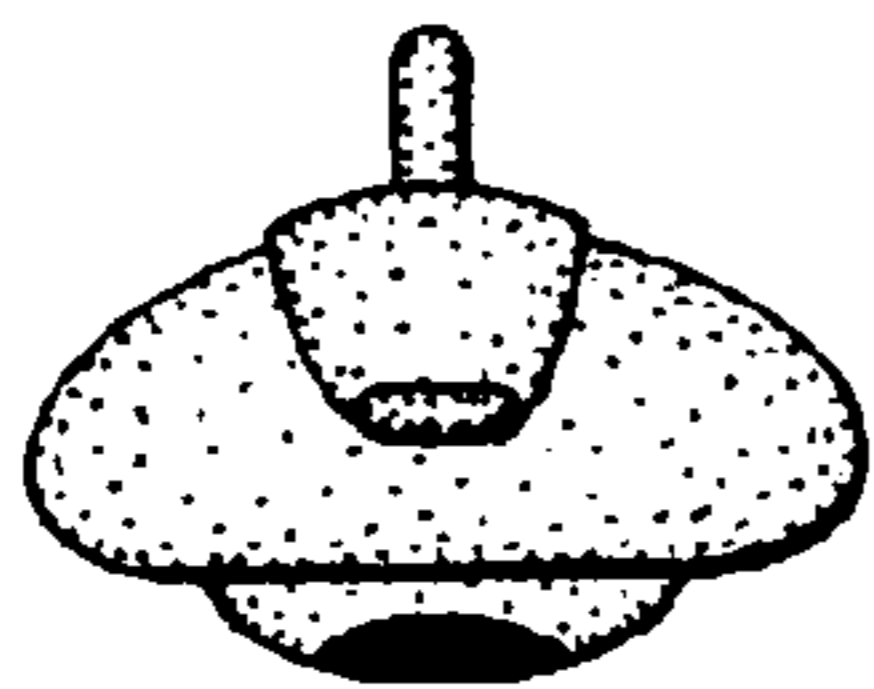

FIG. 5

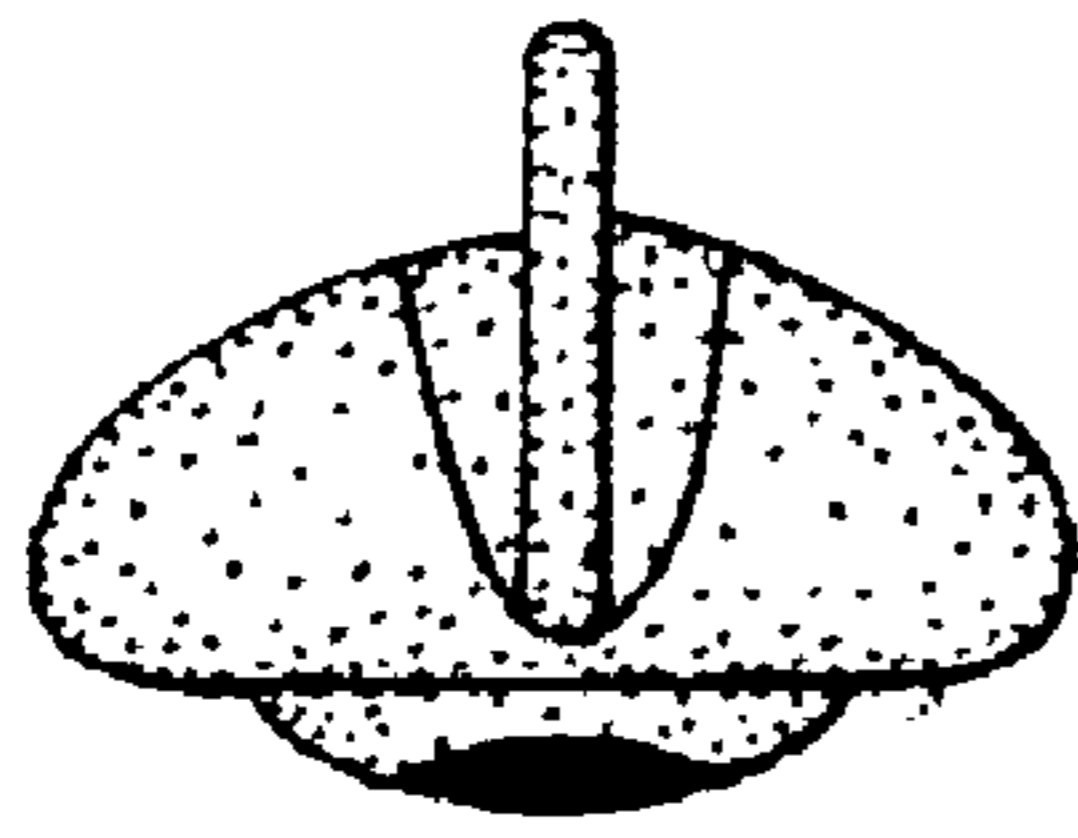

FIG. 6

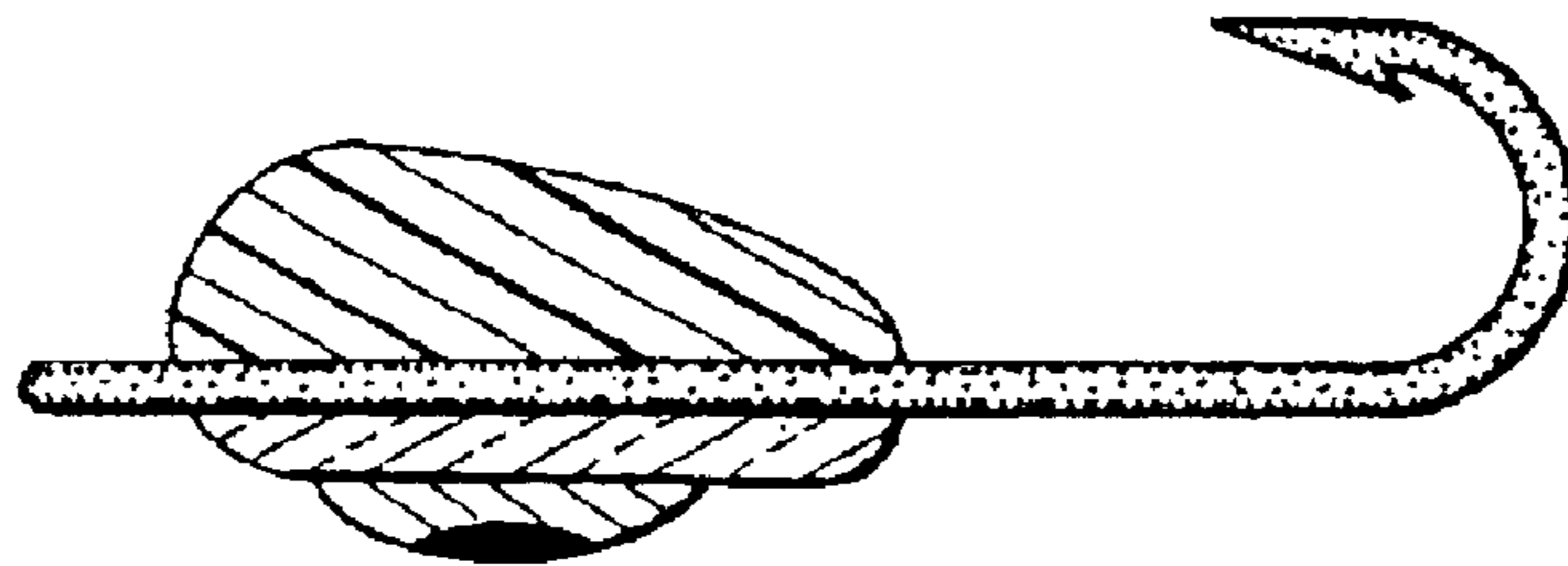

FIG. 7

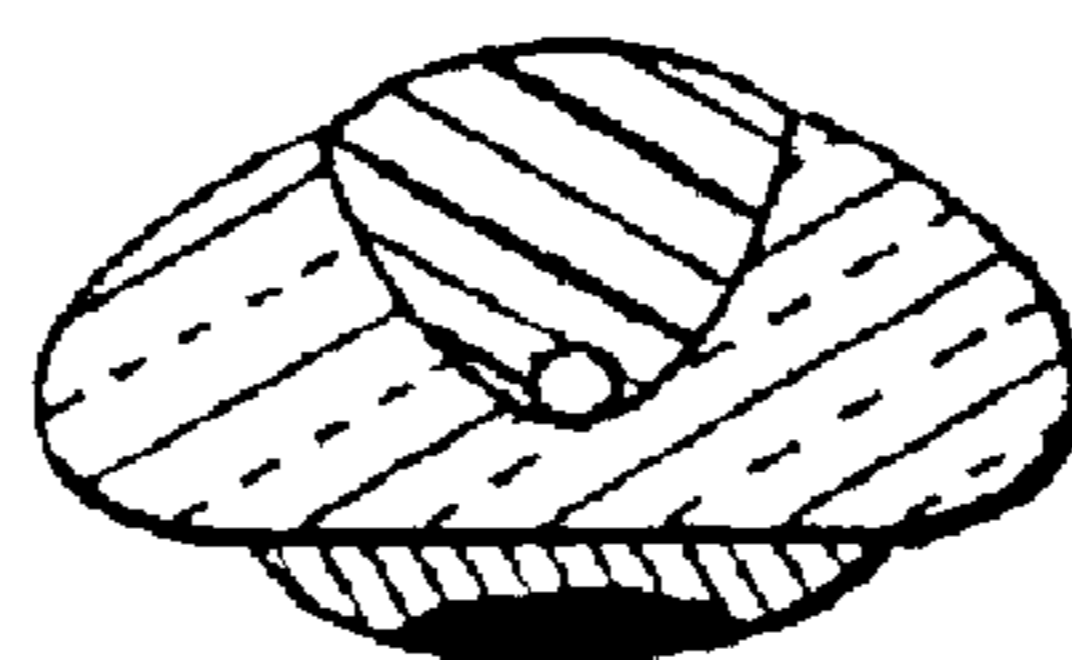

FIG. 8

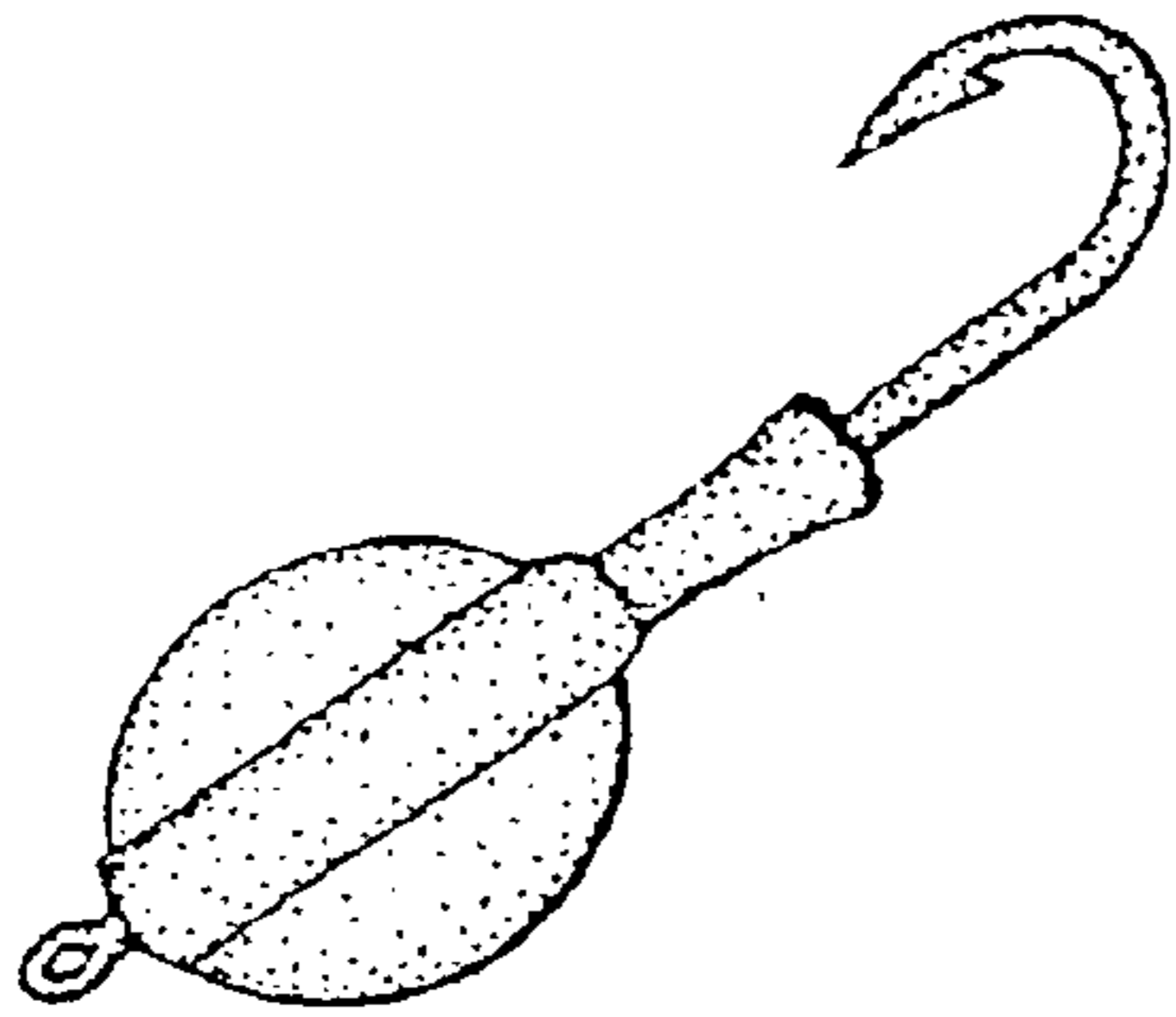

FIG. 9

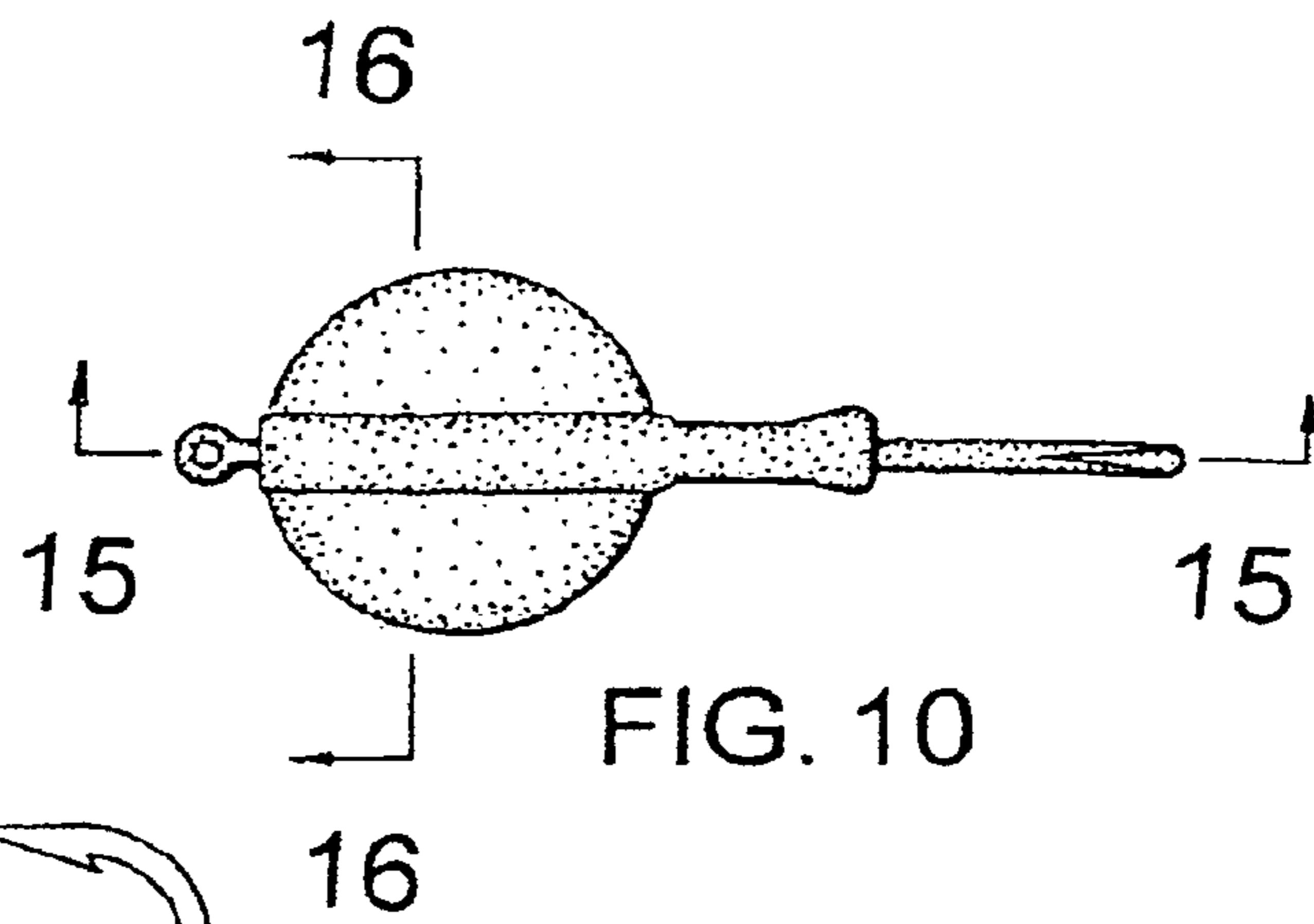

FIG. 10

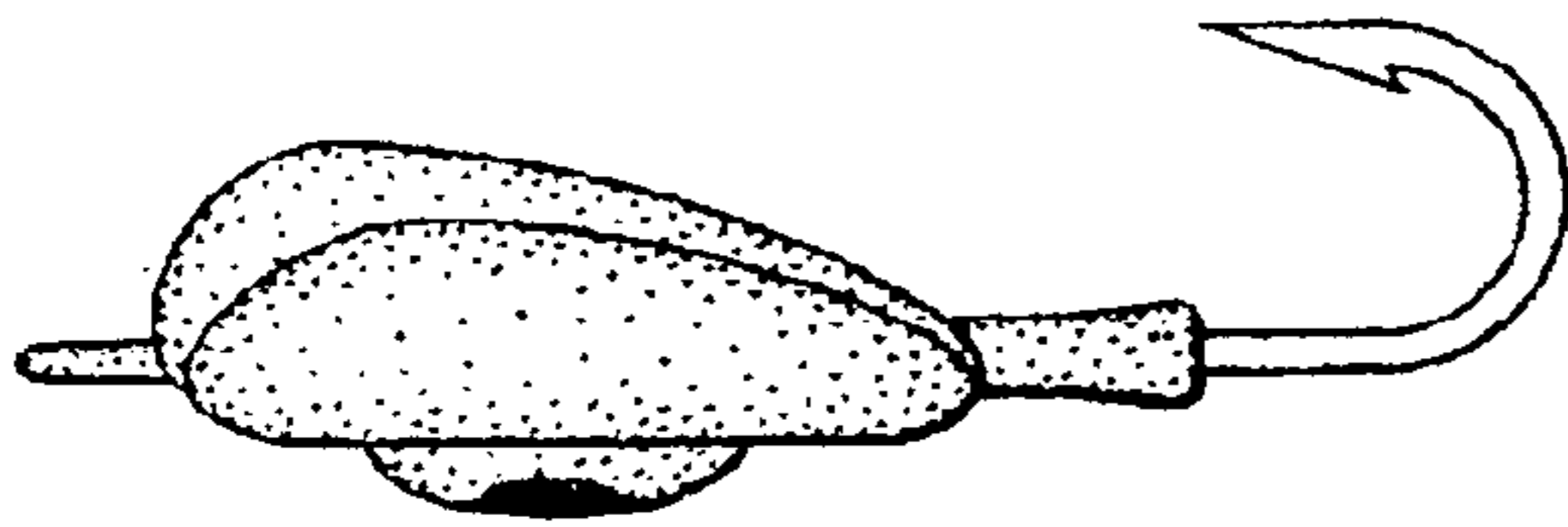

FIG. 11

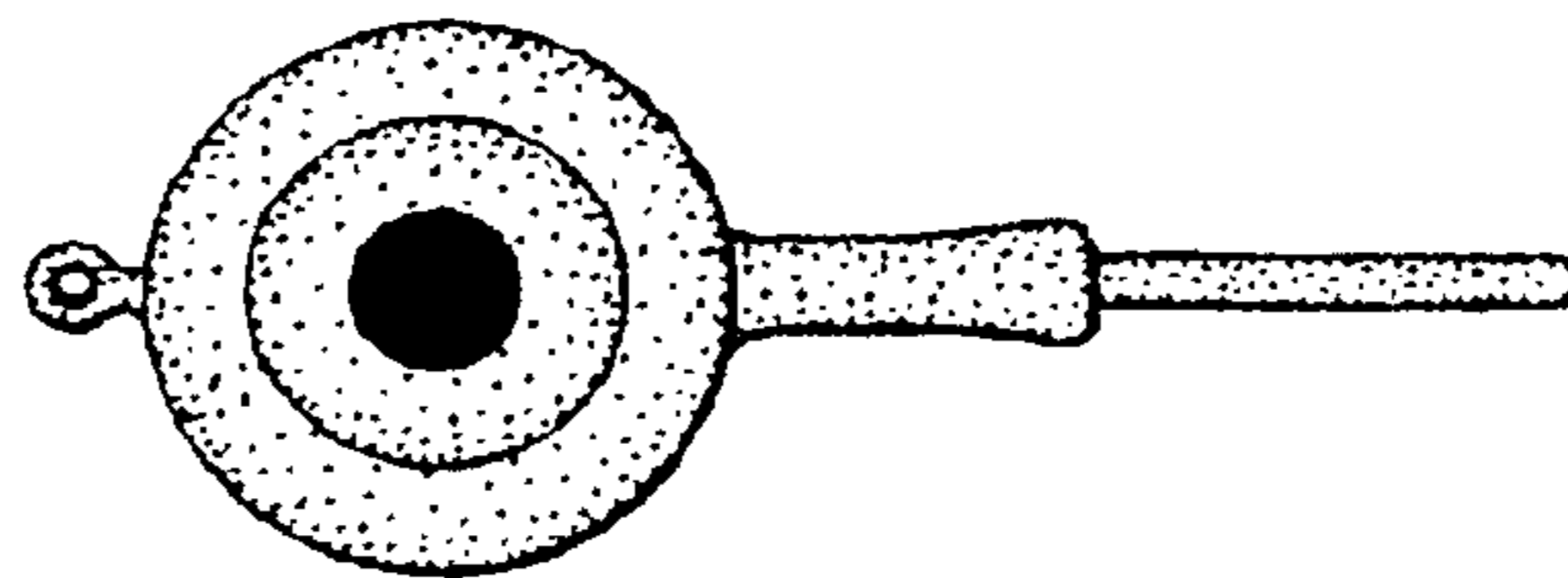

FIG. 12

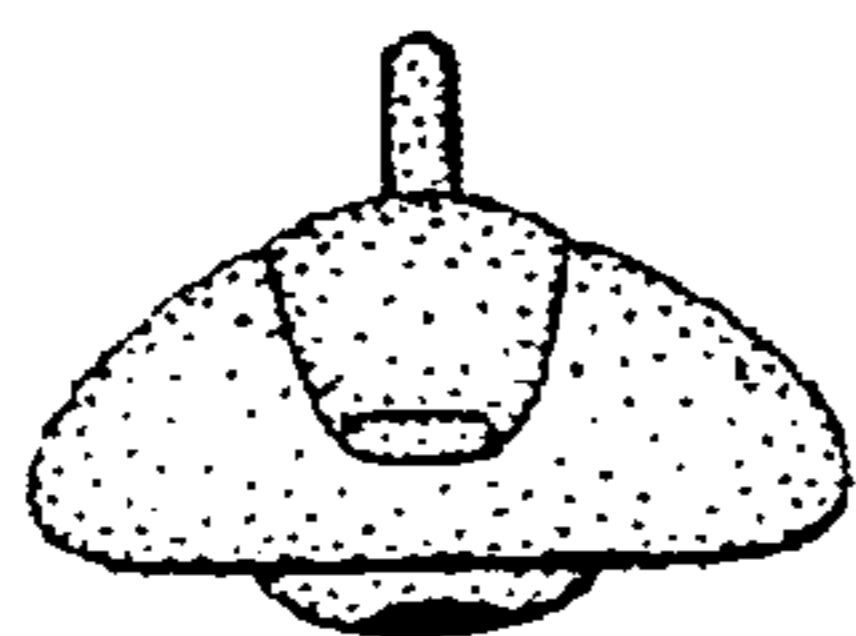

FIG. 13

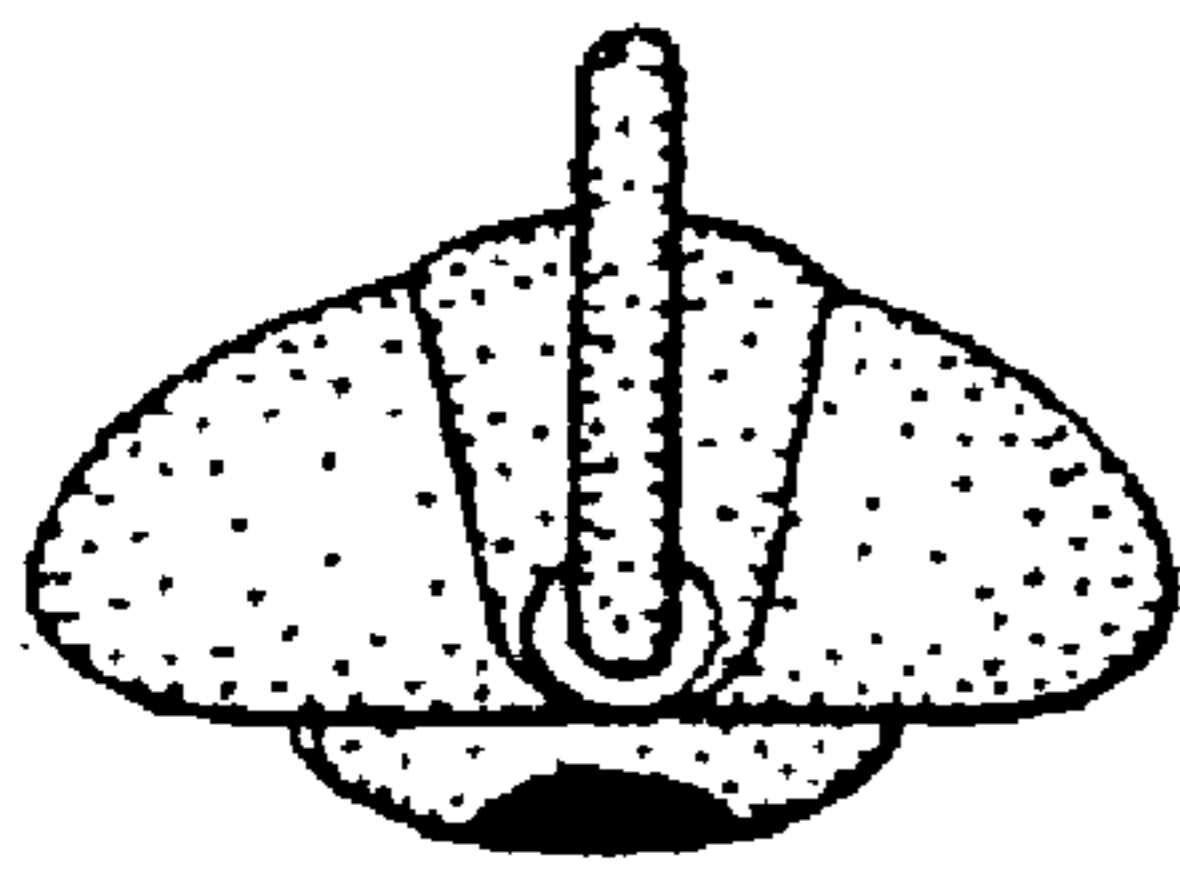

FIG. 14

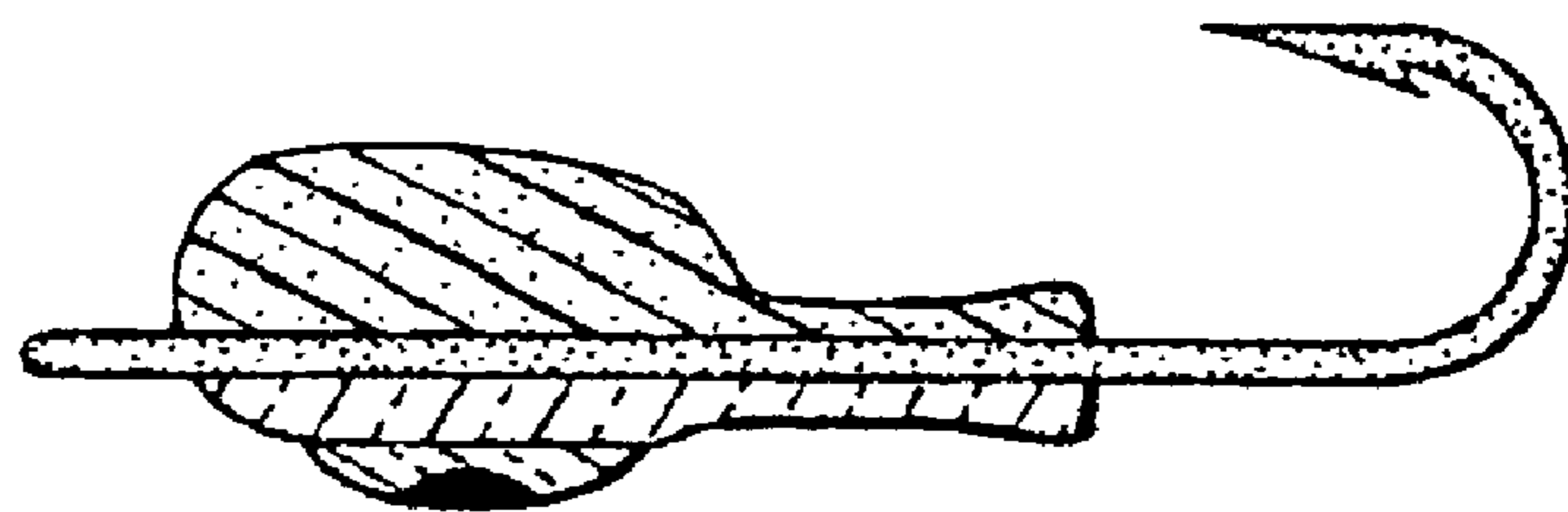

FIG. 15

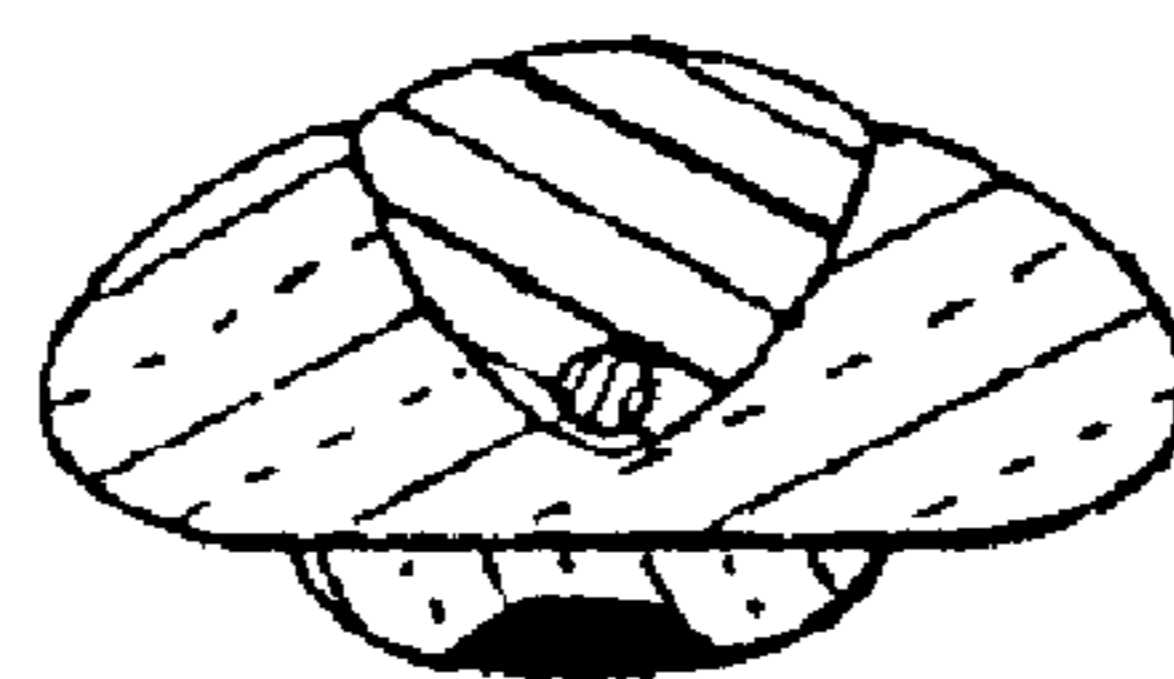

FIG. 16