



US00D511295S

(12) **United States Design Patent**
Schuler et al.

(10) **Patent No.: US D511,295 S**
(45) **Date of Patent: ** Nov. 8, 2005**

- (54) **MUG**
- (75) Inventors: **Daniel Schuler**, Chicago, IL (US);
Peter Schmidt, Chicago, IL (US)
- (73) Assignee: **Thermos L.L.C.**, Rolling Meadows, IL (US)
- (**) Term: **14 Years**
- (21) Appl. No.: **29/219,757**
- (22) Filed: **Dec. 21, 2004**
- (51) **LOC (8) Cl. 08-05**
- (52) **U.S. Cl. D8/360**
- (58) **Field of Search D8/360; 474/170,**
474/94, 174, 902, 903; 29/159 R; 72/68;
228/173.4, 174

6,386,065 B1	5/2002	Hodjat	74/574
D459,197 S	6/2002	Hodjat	D8/360
D459,198 S	6/2002	Hodjat	D8/360
D481,615 S	11/2003	Hodjat et al.	D8/360
D489,962 S	5/2004	Hodjat et al.	D8/360
D492,579 S	7/2004	Hodjat	D8/360

* cited by examiner

Primary Examiner—Ruth McInroy
Assistant Examiner—Terrence Huang

(74) *Attorney, Agent, or Firm*—Wood, Phillips, Katz, Clark & Mortimer

(57) **CLAIM**

The ornamental design of a mug, as shown and described.

DESCRIPTION

FIG. 1 is a rear elevation view of a crankshaft damper showing my new design;
 FIG. 2 is a cross-sectional view of line 2—2 in FIG. 1 thereof;
 FIG. 3 is a front elevation view thereof;
 FIG. 4 is a side view thereof; and
 FIG. 5 is a rear perspective view thereof.
 FIG. 6 is a top plan view of our mug design; and,
 FIG. 7 is a bottom view of our mug design.
 It is to be understood that parts shown in dotted lines form no part of our inventive mug design.

(56) **References Cited**

U.S. PATENT DOCUMENTS

4,824,422 A	*	4/1989	Jocic	474/170
4,824,423 A	*	4/1989	Jocic	474/170
D308,013 S	*	5/1990	Kanemitsu	D8/360
D320,927 S	*	10/1991	Kanemitsu	D8/360
D333,084 S	*	2/1993	Kanemitsu et al.	D8/360
D333,777 S	*	3/1993	Kanemitsu et al.	D8/360
D347,378 S	*	5/1994	Warner	D8/360
5,591,093 A	*	1/1997	Asai et al.	474/94
D450,565 S	*	11/2001	DiBianca	D8/360

1 Claim, 4 Drawing Sheets

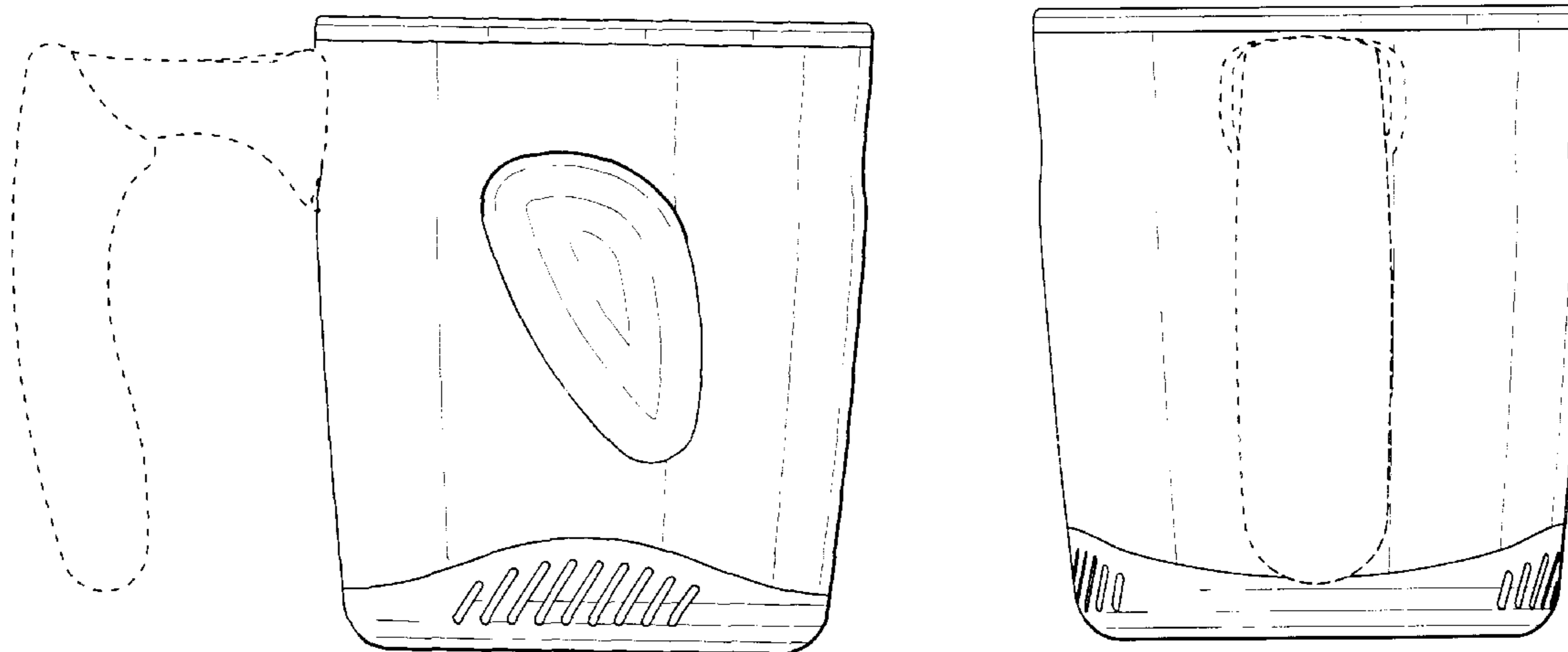

Fig. 1

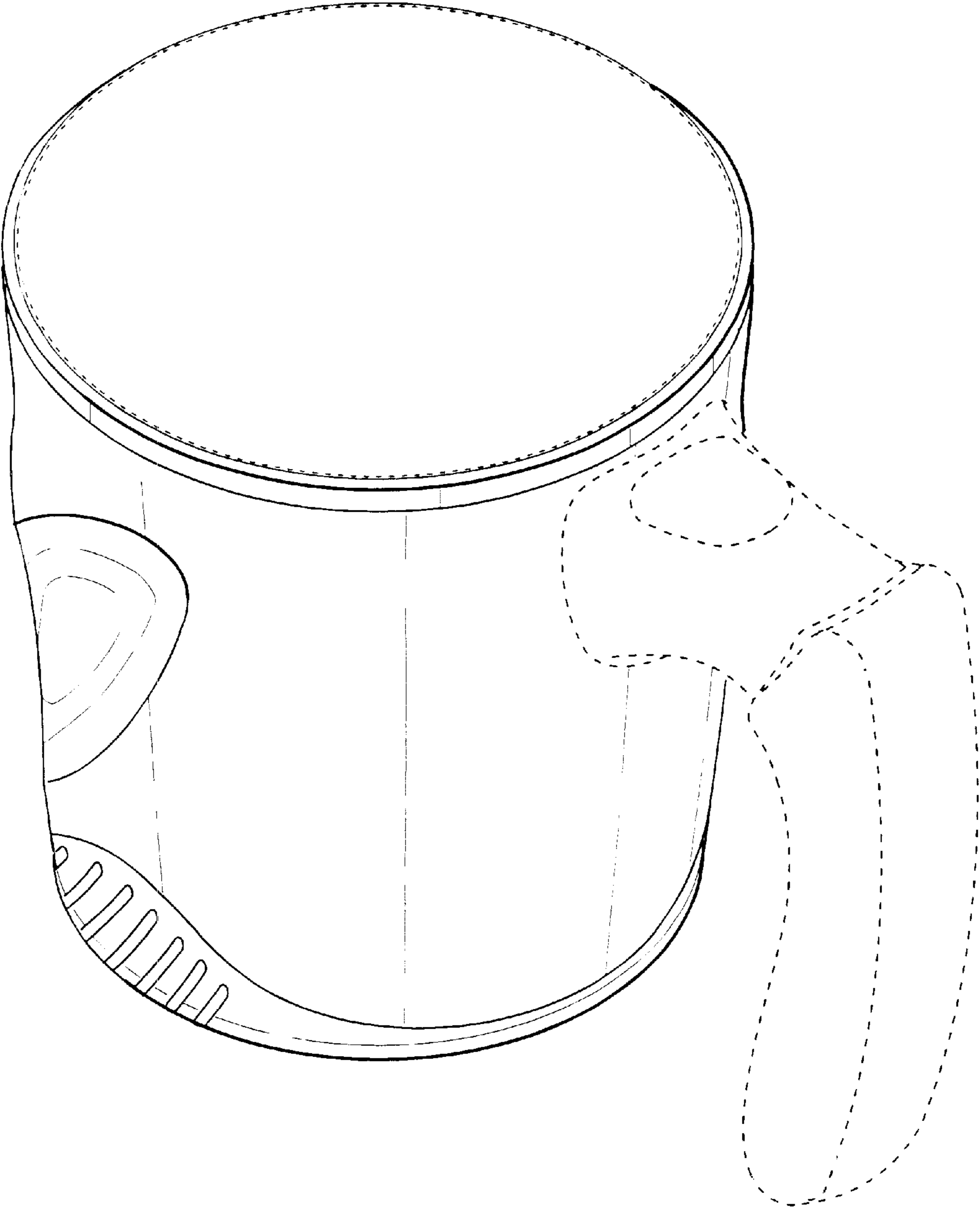

Fig. 2

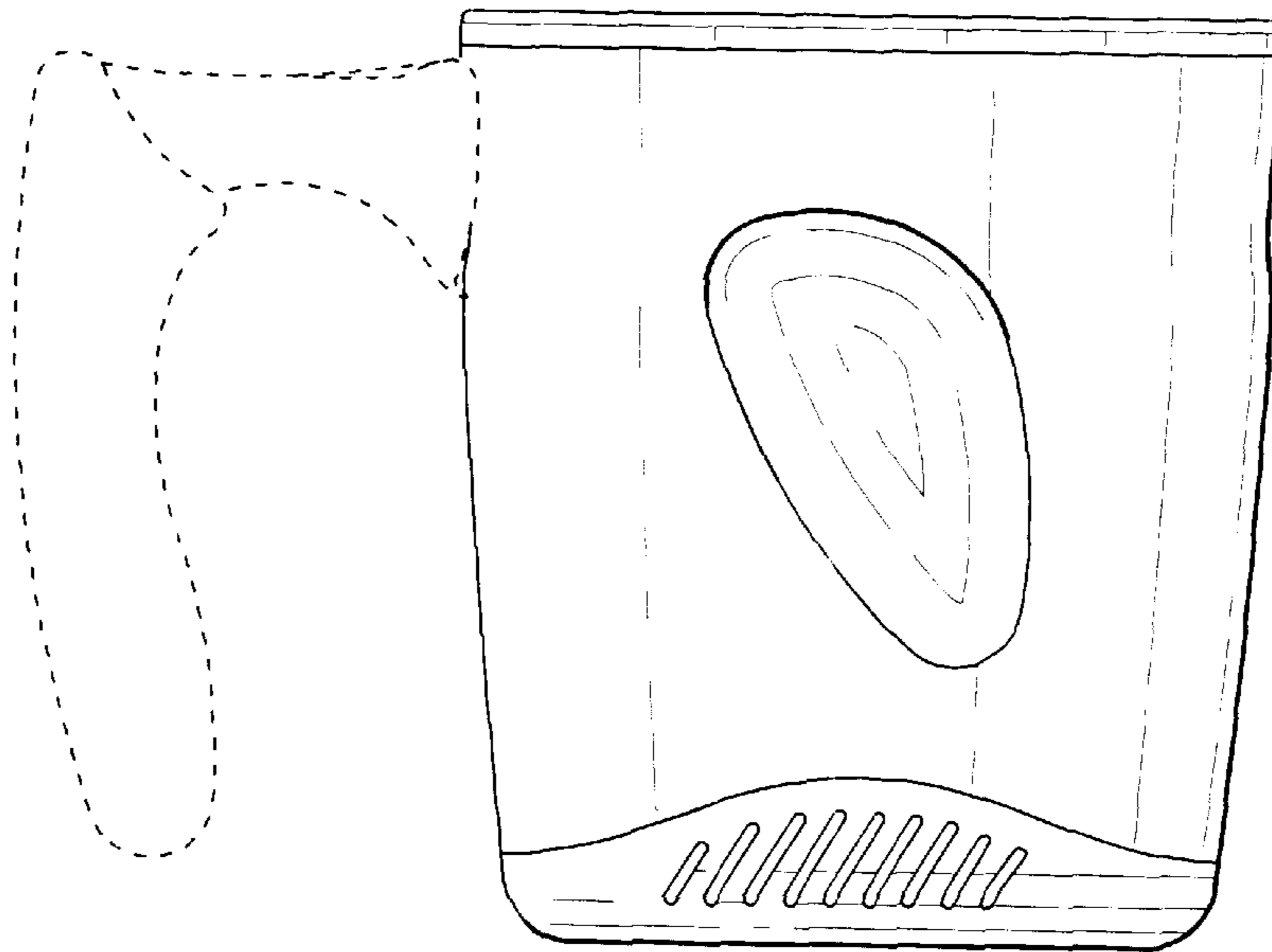

Fig. 3

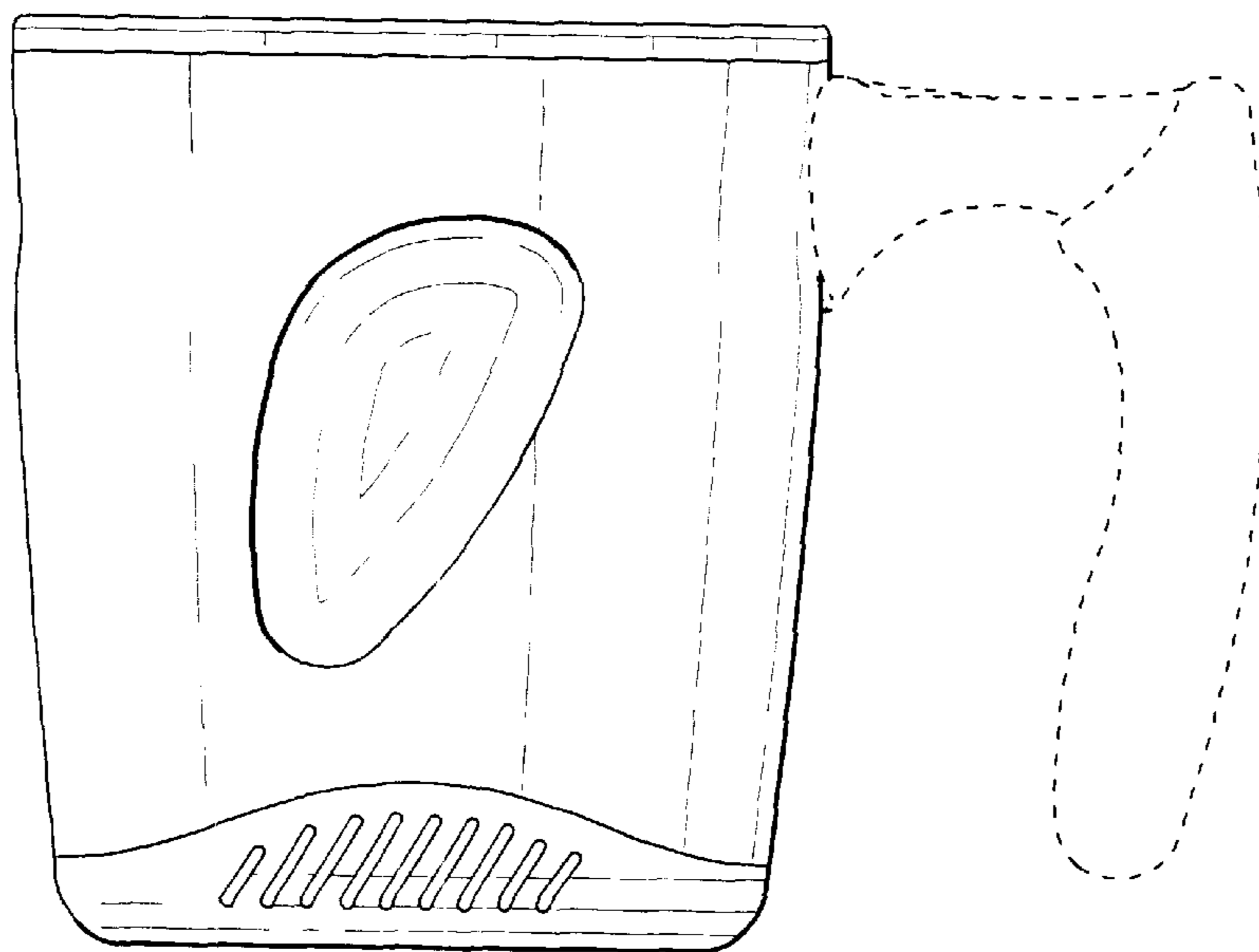

Fig. 4

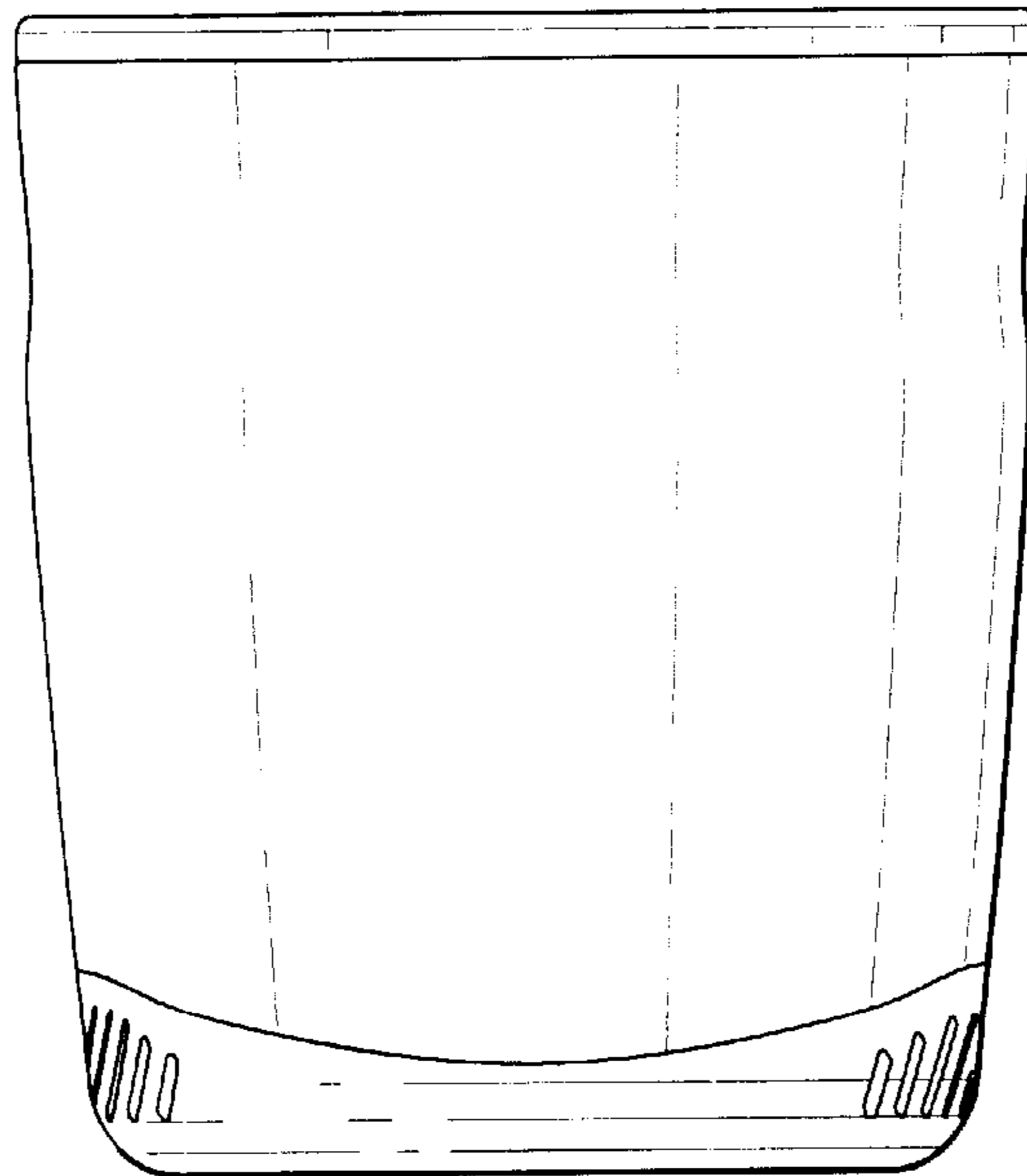

Fig. 5

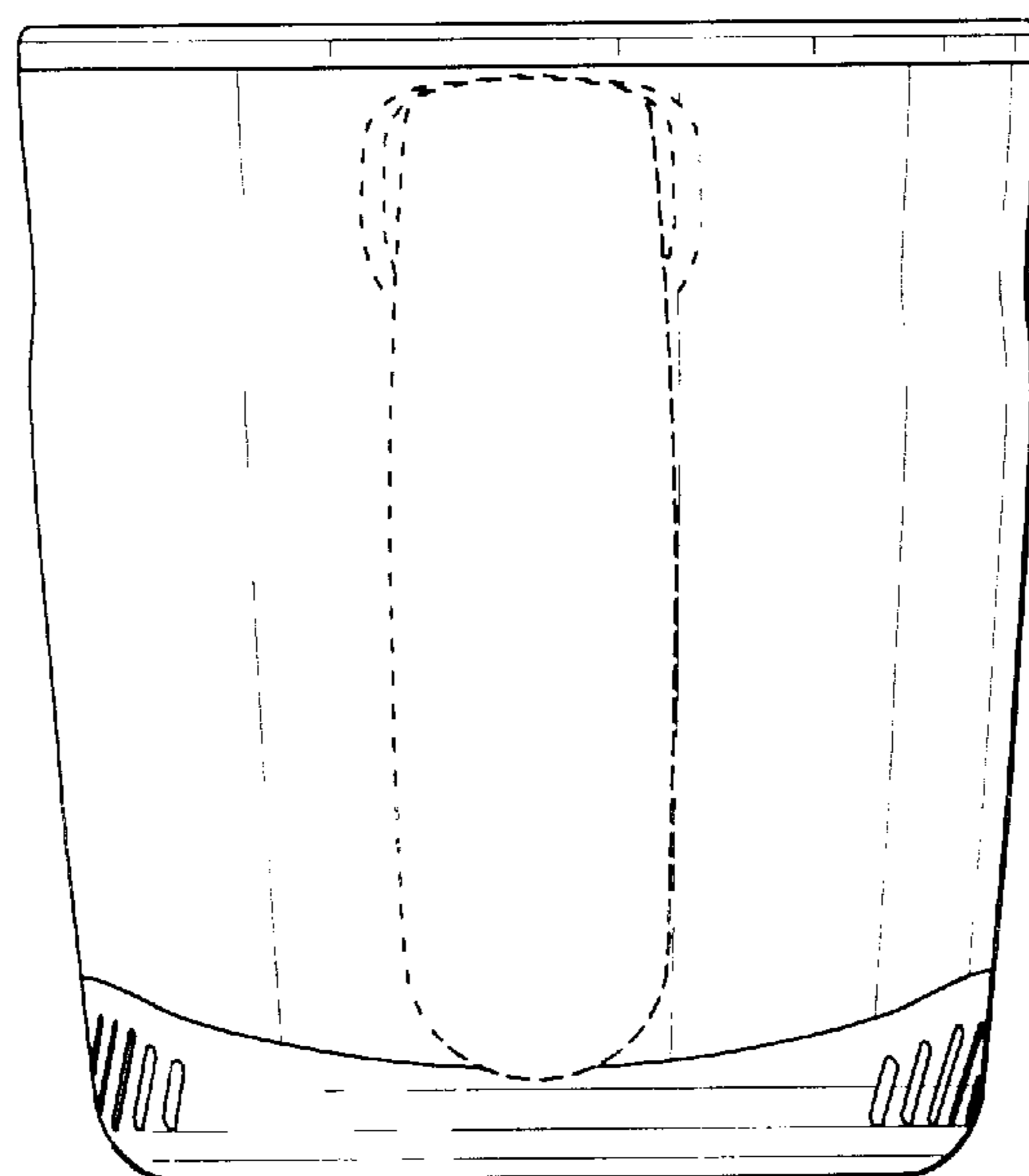

Fig. 6

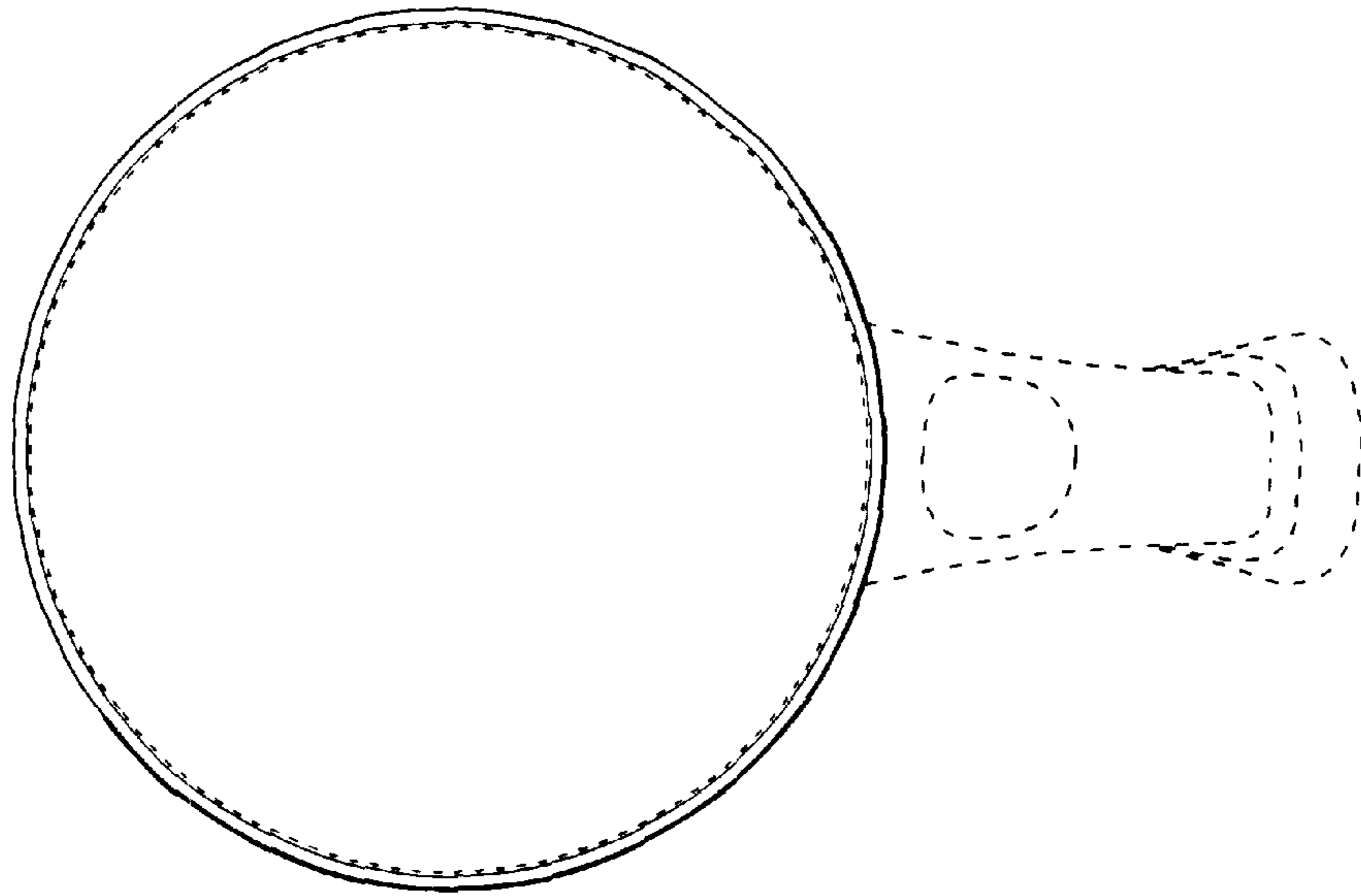

Fig. 7

